

WHARRY



Spare Parts
The Bible



Necks & Bodies	3
Pickups for Guitars / Bases	9
Pickup Covers and Supplies	62
Electronics	73
Tuning Machines	94
Tremolos & Parts	113
Bridge & Tailpieces	127
Nuts & Saddles	143
Fretwire	149
Pickguards & Plates	152
Hardware	164
Instrument Care & Maintenance Kits	190

Schaller

DUESENBERG

golddo

 GOTOH®

KLUSON 

 EARVANA

sandberg 

 ZERO GLIDE

 KTS™

 Dunlop

 VAN ZANDT
PICKUPS

 graphtech
GUITAR LIGES

 Fender

 Seymour
Duncan

 Martin & Co
EST. 1833

 EMG
PICKUPS

 GRETSCH

 Benedetto
The Signature Jazz Guitar Amp

 EVH®

 GROOVETECH
by 

 ghs strings.

 HERCO

ORIGINAL SWISS

 Philippe Bossert

 GUITAR REPAIRS
URS WINKLER
GAMS

NECK &
BODIES





Neck

Neck for
Strat



N007M

Vintage Neck, onepiece - maple unfinished, 7,25" radius, 21 frets (2.1x1,1 mm).



NGS1M

Modern Vintage Neck - maple, 14" rad., 21 frets (2.7x1.1 mm), small headstock, trussrod adjustment, paint.



NGS1R

Modern Vintage Neck - rosewood, 14" rad., 21 frets (2.7x1.1 mm), small headstock, trussrod adjustment, paint.



NGSLR

Modern Vintage Neck - rosewood, 14" rad., 21 frets (2.7x1.1 mm), small headstock, trussrod adjustment, paint.

LEFTHAND



NGSMU

Modern Vintage Neck - maple unfinished, 14" rad., 21 frets (2.7x1.1 mm), small headstock, trussrod adjustment.



NS21BU

Vintage Neck, big head - rosewood unfinished, 7.25" radius, 21 frets (2.1x1.1 mm).



NS21M

Vintage Neck, Onepiece - maple, finished, 7.25" radius, 21 frets (2.1x1.1 mm).



NS21R

Vintage Neck, Onepiece - rosewood, finished, 7.25" radius, 21 frets (2.1x1.1 mm).



NS21U

Vintage Neck, Onepiece - rosewood, unfinished, 7.25" radius, 21 frets (2.1x1.1 mm).



NS22M

Neck, onepiece - maple, finished, 12" radius, 22 frets (2.7x1,0 mm).



NS22R

Neck, onepiece - rosewood, finished, 12" radius, 22 frets (2.7x1,0 mm).



N008M

Vintage Neck for Tele Onepiece - maple, unfinished, 7.25" fingerboard radius, 21 frets (2.1x1.1 mm).

Neck for
Tele



N008R

Vintage Neck for Tele - rosewood, unfinished, 7.25" fingerboard radius, 21 frets (2.1x1.1 mm).



NGT1M

Modern Vintage Neck - maple, 14" radius, 21 frets (2.7x1.1 mm), small headstock, trussrod adjustment, paint.



NGT1R

Modern Vintage Neck - rosewood, 14" radius, 21 frets (2.7x1.1 mm), small headstock, trussrod adjustment, paint.



NT21M

Vintage Neck, Onepiece - maple, finished, 7.25" radius, 21 frets (2.1x1.1 mm).



NT21R

Vintage Neck, Onepiece - rosewood, finished, 7.25" radius, 21 frets (2.1x1.1 mm).



NTBAR

Baritone Neck, Onepiece rosewood, finished, Telly headstock, 14" radius, 24 frets (2.8 x 1.3mm).



Paddle Neck

NG630

Paddle Neck, 630mm scale, mahogany, creme binding, 14" radius, Dual-Action trussrod, Black veneered headstock.



NG647

Paddle Neck, 647mm scale, maple, rosewood fingerboard, 14" radius, dual action trussrod, shafted heads.



Neck for Jazz Bass

NJFLF

Neck for Jazz BASS, fretless, 4-strg, matt finished, Maple with rosewood fingerboard, scale 864mm/34".



Body for Strat

Bodies

LAST ONE

BSA2U

Body f. Strat, SSS, US-Alder, unfinished, 3 single coils, great vintage shaping, ready to paint.



LAST ONE

BSSAU

Body f. Strat, SSS, Swamp Ash, unfinished, for 3 single coils, great vintage shaping, ready to paint.



LAST ONE

BSA3T

Body f. Strat, SSS, US-Alder, 3-tone sunburst, 3 single coils, great vintage shaping, thin laquer.

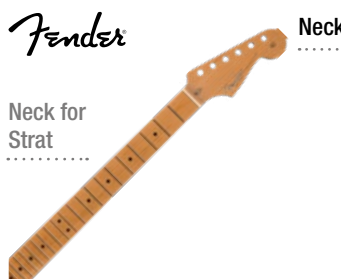

Neck for Strat

Neck

099-3902-920

American Pro II Stratocaster Neck, 22 narrows-tall frets, Roasted Maple, Satin urethane «Super Natural» back finish with gloss headstock, 9.5" radius maple fingerboard.



099-9833-921

60's Stratocaster Neck, C Shape, 21 Vintage Tall Frets, Maple, Road Worn Nitro finish, 7.25" radius pau ferro fingerboard, Vintage-style truss rod adjustment.



099-9972-921

50's Stratocaster Neck, Soft V, 21 Vintage Tall Frets, Maple, Road Worn Nitro finish, 7.25" radius, Vintage-style truss rod adjustment.



099-1002-921

Classic Series 50's Stratocaster Soft V Neck, 21 Vintage Frets, Maple, finished, 7.25" radius, 25.5" scale.

**099-1003-921**

Classic Series 60's Stratocaster C Neck, 21 Vintage Frets, Rosewood, finished, 7.25" radius Pau Ferro fingerboard, 25.5" scale.

**099-1103-921**

Classic Series 60's Stratocaster C Neck, 21 Med. Jumbo Frets, Rosewood, finished, 12" radius Pau Ferro fingerboard.

**099-4552-921**

Player Series Stratocaster Neck w/Block Inlays, 22 Medium Jumbo, Maple, finished, 9.5" radius, Modern C neck profile

**099-4553-921**

Player Series Stratocaster Neck w/Block Inlays, 22 Medium Jumbo, Maple, finished, 9.5" radius, Modern C neck profile, pau ferro fingerboard

Neck for Tele

**099-3942-920**

American Pro II Telecaster Neck, 22 narrows-tall frets, Roasted Maple, Satin urethane «Super Natural» back finish with gloss headstock, 9.5" radius maple fingerboard.

**099-9712-921**

70's Telecaster Deluxe Neck, C Shape, 21 Medium Jumbo Frets, Maple, Road Worn Nitro finish, 9.5" radius, bullet-style truss rod adjustment.

**099-9872-921**

'50s Telecaster Neck, U Shape, 21 Vintage Tall Frets, Maple, Road Worn Nitro finish, 7.25" radius, Vintage-style truss rod adjustment.

**099-1202-921**

Classic Series 50's Telecaster C Neck, 21 Vintage Frets, Maple, finished, 7.25" radius, 25.5" scale.

**099-5252-921**

Player Series Telecaster Neck w/Block Inlays, 22 Medium Jumbo Frets, Maple, finished, 9.5" radius, Modern C neck profile

**099-9862-920**

Vintera Mod 50's Telecaster V Neck, 21 Medium Jumbo Frets, Roasted Maple, finished, 9.5" radius. Vintage style «soft V» neck profile

**099-0602-920**

Roasted Maple Telecaster C Neck, 21 Narrow Tall Frets, Roasted Maple, finished, 9.5" radius.

**099-0215-921**

American Channel Bound Telecaster Modern C Neck, 21 Medium Jumbo Frets, Rosewood, finished, 9.5"-14" compound-radius fingerboard

**099-5253-921**

Player Series Telecaster Neck w/Block Inlays, 22 Medium Jumbo, Maple, finished, 9.5" radius, Modern C neck profile, pau ferro fingerboard

**099-0402-921**

Sub-Sonic Baritone Telecaster Modern C Neck, 22 Med. Jumbo Frets, Maple, 9.5" radius maple fingerboard. Conversion to 27" baritone scale length

**099-1713-921**

Classic Player Jaguar C Neck, 22 Medium Jumbo Frets, Pau Ferro, finished, 9.5" radius

**099-2202-920**

Roasted Jazzmaster Modern C Neck w/Black Block Inlays, 22 Medium Jumbo Frets, Maple, finished, 9.5" radius

Neck for Jaguar

Neck for Jazzmaster



099-2203-920
Roasted Jazzmaster Modern C Neck w/Pearloid Block Inlays, 22 Medium Jumbo Frets, Maple, finished, 9.5"radius



099-1613-921
Classic Player Jazzmaster C Neck, 21 Medium Jumbo Frets, Pau Ferro, finished, 9.5"radius

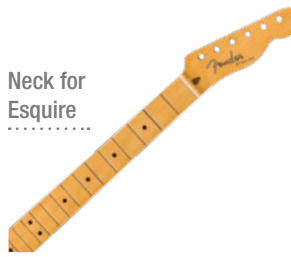

Neck for Esquire

099-0216-921
'50's Esquire U Neck, 21 Vintage Frets, Maple, smooth satin urethane finish front & back/gloss headstock, 7.25" radius.



099-0217-920
'50'S modified Esquire U Neck, 22 narrow tall frets, Roasted Maple, smooth satin urethane finish front & back/gloss headstock, 9.5" radius.



Neck for P Bass

099-1712-921
'50's Precision BASS C Neck, 20 Vintage Frets, Maple, Road Worn Nitro finish, 7.25" radius, Vintage-style truss rod adjustment.



099-2010-921
Classic Series 70's Precision BASS C Neck, 20 Med. Jumbo Frets, Maple with walnut «skunk» stripe, finished, 9.5" radius, 34" scale, pre-slotted nut, block inlay.



099-0302-921
P to J BASS C Neck, 20 Medium Jumbo Frets, Maple, smooth satin urethane finish front & back/gloss headstock, 12" radius Maple fingerboard.



099-0303-921
P to J BASS C Neck, 20 Medium Jumbo Frets, Maple, smooth satin urethane finish front & back/gloss headstock, 12" radius Pau Ferro fingerboard.



Neck for Jazz Bass

099-0226-921
'60's Jazz BASS C Neck, 20 Medium Jumbo Frets, Maple, Road Worn Nitro finish, 9.5" radius Pau Ferro fingerboard, Vintage-style truss rod adjustment.

Bodies



Body for Strat

099-8003-700
Classic Series 60's Stratocaster SSS Alder Body, Vintage Bridge Mount, 3-Color Sunburst, gloss polyester finish.



099-8003-706
Classic Series 60's Stratocaster SSS Alder Body, Vintage Bridge Mount, Black, gloss polyester finish.



099-8003-709
Classic Series 60's Stratocaster SSS Alder Body, Vintage Bridge Mount, Candy Apple Red, gloss polyester finish.



Body for Tele

099-8006-705
Classic Series 60's Telecaster SS Alder Body, Vintage Bridge Mount, Olympic White, gloss polyester finish.



099-8006-706

Classic Series 60's Telecaster SS Alder Body, Vintage Bridge Mount, Black, gloss polyester finish.



099-8006-709

Classic Series 60's Telecaster SS Alder Body, Vintage Bridge Mount, Candy Apple Red, gloss polyester finish.

Body for Bass



099-8010-732

Standard Series Precision BASS Alder Body, Vintage Bridge Mount, Brown Sunburst, gloss polyester finish.



099-8010-780

Standard Series Precision BASS Alder Body, Vintage Bridge Mount, Arctic White, gloss polyester finish.



099-8008-706

Standard Series Jazz BASS SS Alder Body, Vintage Bridge Mount, Black, gloss polyester finish.



099-8008-732

Standard Series Jazz BASS SS Alder Body, Vintage Bridge Mount, Brown Sunburst, gloss polyester finish.

PICKUPS FOR
GUITARS / BASSES



DIEGO



Pickup
for Strat

PSC0P

Twin Blade, black. Humbucker for Strat, single coil size, 4-conductor cable. High output and warm sound.



PSCPW

Twin Blade, white. Humbucker for Strat, single coil size, 4-conductor cable. High output and warm sound.

Pickup
for Tele



PTLTB

Twin Blade, black. Humbucker for Tele bridge position, single coil size, 4-conductor cable.



PTLTW

Twin Blade, white. Humbucker for Tele, bridge position, single coil size, 4-conductor cable.



FBV1

Mini Humbucker nickel.



PP000

Piezo Discs - Set of 6. Round Piezo elements which pick up nearly everything - guitar, drums - whatever.



P9BBB

Domino P90 bridge, big Alnico singlecoil with medium output, well balanced, dynamic attack and a unique sound.



P9NBB

Domino P90 neck, big Alnico singlecoil with medium output, well balanced, dynamic attack and a unique sound.



P9BNB

Domino P90 bridge, nickel. Big Alnico singlecoil with medium output, well balanced, dynamic attack & a unique sound.



P9NNB

Domino P90 neck, nickel. Big Alnico singlecoil with medium output, well balanced, dynamic attack & a unique sound.



P9BGB

Domino P90 bridge, gold. Big Alnico singlecoil with medium output, well balanced, dynamic attack & a unique sound.



P9NGB

Domino P90 neck, gold. Big Alnico singlecoil with medium output, well balanced, dynamic attack & a unique sound.



PTBNB

Frantz P90 Pickup, neck/bridge, silver. A big singlecoil with low to medium output, well balanced frequency response and a unique crystal clear sound.



PD4BB

CrunchBucker Pickup, bridge, nickel. Alnico humbucker with high output (16,9kOhm), a frequency response and a punchy but open Rock sound.



PDDBG

D-Tron Humbucker, bridge, gold. Alnico humbucker with a medium output & a defined, clear & shimmery sound with perfect overtone reproduction.



PDDNG

D-Tron Humbucker, neck, gold. Alnico humbucker with a medium output & a defined, clear & shimmery sound with perfect overtone reproduction.



PDDBN

D-Tron Humbucker, bridge, nickel. Alnico humbucker with a medium output & a defined, clear & shimmering sound with perfect overtone reproduction.



PDDNN

D-Tron Humbucker, neck, nickel. Alnico humbucker with a medium output & a defined, clear & shimmering sound with perfect overtone reproduction.



PDM1N

DS Alnico Blade Pickup, neck, nickel. A reproduction of the old Gibson Melody Maker pickups. Unique & very open sound.



PDS1B

VintageClass Singlecoil, bridge, nickel. Typical Alnico singlecoil pickup. Fast dynamics and a brilliant sound.



PDS1M

VintageClass Singlecoil, middle, nickel. Typical Alnico singlecoil pickup. Fast dynamics and a brilliant sound.



PDS1N

VintageClass Singlecoil, neck, nickel. Typical Alnico singlecoil pickup. Fast dynamics and a brilliant sound.



PDTBG

LittleToaster, bridge, gold. A new small humbucker with surprising pearly acoustic high treble response.



PDTNG

LittleToaster, neck, gold. A new small humbucker with surprising pearly acoustic high treble response.



PDTBN

LittleToaster, bridge, nickel. A new small humbucker with surprising pearly acoustic high treble response.



PDTNN

LittleToaster, neck, nickel. A new small humbucker with surprising pearly acoustic high treble response.



PFDBC

GrandVintage Humbucker, bridge, nickel. Alnico humbucker with a classic voicing that transports the sound of the 50's into the present.



PFDNC

GrandVintage Humbucker, neck, nickel. Alnico humbucker with a classic voicing that transports the sound of the 50's into the present.



PFDBG

GrandVintage Humbucker, bridge, gold. Alnico humbucker with a classic voicing that transports the sound of the 50's into the present.



PH9BN

SingleTwin Domino, bridge, nickel. A big, hum free Alnico singlecoil pickup who delivers the sought after authentic singlecoil-P90-sound.



PH9NN

SingleTwin Domino, neck, nickel. A big, hum free Alnico singlecoil pickup who delivers the sought after authentic singlecoil-P90-sound.



PSTBN

SingleTwin Mini, bridge, nickel. A hum free Alnico singlecoil pickup in mini humbucker format.



PSTNN

SingleTwin Mini, neck, nickel. A hum free Alnico singlecoil pickup in mini humbucker format.



PSTBG

SingleTwin Mini, bridge, gold. A hum free Alnico singlecoil pickup in mini humbucker format.



PSTNG

SingleTwin Mini, neck, gold. A hum free Alnico singlecoil pickup in mini humbucker format.



Active Humbucker Pickups



EMG-81

Active Guitar 81, Humbucker, black. Incredible amounts of high end cut, & fluid sustain.



EMG-81-IVO

Active Guitar 81, Humbucker, ivory. Incredible amounts of high end cut, & fluid sustain.



EMG-81-BBC

Active Guitar 81, Humbucker, brushed black chrome. Incredible amounts of high end cut, & fluid sustain.



EMG-81-C

Active Guitar 81, Humbucker, chrome. Incredible amounts of high end cut, & fluid sustain.



EMG-81-G

Active Guitar 81, Humbucker, gold. Incredible amounts of high end cut, & fluid sustain.



EMG-81-WHT

Active Guitar 81, Humbucker, white. Incredible amounts of high end cut, & fluid sustain.



EMG-81-RED

Active Guitar 81, Humbucker, red. Incredible amounts of high end cut, & fluid sustain.



EMG-81-7

Active Guitar 81 7-String, Humbucker, black. Incredible amounts of high end cut, & fluid sustain.



EMG-81-8

Active Guitar 81 8-String, Humbucker, black. Incredible amounts of high end cut, & fluid sustain.



EMG-81TW

Active Guitar 81TW, Humbucker, black. Taking the 81 & adding a separate single coil pickup in the same housing. Gives players 2 classic tonal options to choose from.



EMG-85

Active Guitar 85, Humbucker, black. With Alnico V magnets, a powerful pickup w/ great tone & versatility.



EMG-85-BBC

Active Guitar 85, Humbucker, brushed black chrome. With Alnico V magnets, a powerful pickup w/ great tone & versatility.



EMG-85-C

Active Guitar **85**, Humbucker, chrome. With Alnico V magnets, a powerful pickup w/ great tone & versatility.



EMG-85-G

Active Guitar **85**, Humbucker, gold. With Alnico V magnets, a powerful pickup w/ great tone & versatility.



EMG-85-WHT

Active Guitar **85**, Humbucker, white. With Alnico V magnets, a powerful pickup w/ great tone & versatility.



EMG-60

Active Guitar **60**, Humbucker, black. Crisp highs and plenty of mid-range for rich tone, rich harmonic overtones.



EMG-60-BBC

Active Guitar **60**, Humbucker, brushed black chrome. Crisp highs and plenty of mid-range for rich tone.



EMG-60-C

Active Guitar **60**, Humbucker, chrome. Crisp highs and plenty of mid-range for rich tone, rich harmonic overtones.



EMG-60-G

Active Guitar **60**, Humbucker, gold. Crisp highs and plenty of mid-range for rich tone, rich harmonic overtones.



EMG-60-WHT

Active Guitar **60**, Humbucker, white. Crisp highs and plenty of mid-range for rich tone, rich harmonic overtones.



EMG-60-RED

Active Guitar **60**, Humbucker, red. Crisp highs and plenty of mid-range for rich tone, rich harmonic overtones.



EMG-60-7

Active Guitar **60**, 7-String, Humbucker, black. Crisp highs and plenty of mid-range for rich tone.



EMG-60-8

Active Guitar **60**, 8-String, Humbucker, black. Crisp highs and plenty of mid-range for rich tone.



EMG-60A

Active Guitar **60A**, Humbucker, black. Alnico magnets give the 60 a much warmer overall tone.



EMG-60A-IVO

Active Guitar **60A**, Humbucker, ivory. Alnico magnets give the 60 a much warmer overall tone.



EMG-58

Active Guitar **58**, Humbucker, black. Classic tone combining Alnico magnets and Steel bars.



EMG-57-BLK

Active Guitar **57**, Humbucker, black. PAF design with Alnico magnets and Steel poles for bridge position only.



EMG-57-CHR

Active Guitar **57**, Humbucker, chrome. PAF design with Alnico magnets and Steel poles for bridge position only.



EMG-57-7-BLK

Active Guitar 57, 7-String, Humbucker, black. PAF design with Alnico magnets and Steel poles for bridge position only.



EMG-66-BLK

Active Guitar 66, Humbucker, black. Warm, smooth mid-range & expansive lows with Alnico magnets + Ceramic poles for neck position only.



EMG-66-CHR

Active Guitar 66, Humbucker, chrome. Warm, smooth mid-range & expansive lows with Alnico magnets + Ceramic poles for neck position only.



EMG-66-7-BLK

Active Guitar 66, 7-String, Humbucker, black. Neck. Warm, smooth mid-range & expansive lows with Alnico magnets.



EMG-57/66-BBC

Active Guitar 57/66 Set, Humbucker, brushed black chrome. Our bridge 57 and neck 66 together in one package.



EMG-57/66-C

Active Guitar 57/66 Set, Humbucker, chrome. Our bridge 57 and neck 66 together in one package.



EMG-57/66-BC

Active Guitar 57/66 Set, Humbucker, brushed chrome. Our bridge 57 and neck 66 together in one package.



EMG-57/66-G

Active Guitar 57/66 Set, Humbucker, gold. Our bridge 57 and neck 66 together in one package.



EMG-89

Active Guitar 89, Humbucker, black. A dual mode humbucker with our SA single coil & a dual coil similar to our 85.



EMG-89R

Active Guitar 89, Humbucker, black. Similar to the 89 but the coils are reversed. Closer to the neck to capture the sweet spot Strat fans love.



EMG-H

Active Guitar H, Humbucker, black. Single coil pickup in a Humbucker housing w/ Ceramic magnets for a brighter tone.



EMG-707

Active Guitar 707, 7-String, black. Humbucker, beef up the Low B string tone while maintaining a balanced and articulate upper register.



EMG-707-RED

Active Guitar 707, 7-String, red. Humbucker, beef up the Low B string tone while maintaining a balanced and articulate upper register.



EMG-808

Active Guitar 808, 8-String, black. Humbucker. Based on the 707, it gives players all the tone, presence & dynamics they ask.



EMG-M-50/M-60-SET

Active Guitar M50/M60 Set, black. Mini-Humbucker. Combined the beefy sound of the bridge M-50 with the real clean tone of the neck M-60.



EMG-M-80/M-60-SET

Active Guitar M80/M60 Set, black. Mini-Humbucker. Combined the «Stick of Dynamite» M-80 bridge with the real clean tone of the neck M-60.

Active Single Coil
Pickups



EMG-SA

Single Coil Active Guitar **SA**, black. Loaded with an Alnico V bar magnet that has an unmistakable Strat™ sound: bright, airy, rich bottom end.



EMG-SA-IVO

Single Coil Active Guitar **SA**, ivory. Loaded with an Alnico V bar magnet that has an unmistakable Strat™ sound: bright, airy, rich bottom end.



EMG-SA-WHT

Single Coil Active Guitar **SA**, ivory. Loaded with an Alnico V bar magnet that has an unmistakable Strat™ sound: bright, airy, rich bottom end.



EMG-SA-SET

Single Coil Active Guitar **SA Set**, black. Combine 3 of our SA pickups, produce an early Strat tone with added mid-range response + higher output.



EMG-SA-SET-IVO

Single Coil Active Guitar **SA Set**, ivory. Combine 3 of our SA pickups produces an early Strat tone with added mid-range response and higher output.



EMG-SA-SET-WHT

Single Coil Active Guitar **SA Set**, white. Combine 3 of our SA pickups produces an early Strat tone with added mid-range response and higher output.



EMG-SAV-IVO

Single Coil Active Guitar **SAV**, ivory. Has all the tone, clarity, & responsiveness guitar players demand with a vintage look enthusiasts will love.



EMG-S

Single Coil Active Guitar **S**, black. Bright & clear single-coil pickup, without the hum. Virtually noiseless, it provides a balanced guitar tone.



EMG-S-IVO

Single Coil Active Guitar **S**, ivory. Bright & clear single-coil pickup, without the hum. Virtually noiseless, it provides a balanced guitar tone.



EMG-S-WHT

Single Coil Active Guitar **S**, white. Bright & clear single-coil pickup, without the hum. Virtually noiseless, it provides a balanced guitar tone.



EMG-S/S/81

Single Coil Active Guitar + Humbucker Set, black. Has S (neck), S (mid), & 81 bridge all solderless install for high output set up. For Strat.



EMG-SA/SA/81

Single Coil Active Guitar + Humbucker Set, black. SA (neck), SA (mid), and 81 (bridge) all solderless install for a powerful combination. For Strat.



EMG-SA/SA/81-IVO

Single Coil Active Guitar + Humbucker Set, Ivory. SA (neck), SA (mid), and 81 (bridge) all solderless install for a powerful combination. For Strat.



EMG-SA/SA/81-WHT

Single Coil Active Guitar + Humbucker Set, white. SA (neck), SA (mid), and 81 (bridge) all solderless install for a powerful combination. For Strat.



EMG-SLV

Single Coil **SLV** Active Guitar, black. The single coil over wound out of the SLV Set good in any position. For Strat.



EMG-FT

Single Coil Active Guitar **FT**, black. This Front Tele pickup gives you all the twang & punch you'd expect with incredible clarity & definition.

Active P-90
Pickups



EMG-RT

Single Coil Active Guitar **RT**, black. Uses Alnico magnets with a custom coil & winding to give your sound fullness & a broader bandwidth. For Tele.



EMG-T-SET

Single Coil Active Guitar **RT/FT Set**, black. Alnico V magnets in rear (RT) and front (FT) pickups give you blues rock or twang country. For Tele.



EMG-TC-SET-IVO

Single Coil Active Guitar **TC Set**, ivory. Our T Set with Ceramic magnets for crisp high end and less mids for more "chicken-picken" tone. For Tele.



EMG-P60-IVO

Active **P-60** Guitar, ivory. P90 style housing. Packs plenty of output with a balance of thick, boosted mids, big lows & singing highs.



EMG-P60A-BLK

Active **P-60A** Guitar, black. P90 style housing. Packs plenty of output with a balance of thick, boosted mids, big lows & singing highs.



EMG-P81

Active **P-81** Guitar, black. Our famed 81 pickup with a ceramic magnet in a P90 housing. Intensity, big amounts of high end cut, & fluid sustain.



EMG-P81-IVO

Active **P-81** Guitar, ivory. Our famed 81 pickup with a ceramic magnet in a P90 housing. Intensity, big amounts of high end cut, & fluid sustain.



EMG-P85-BLK

Active **P-85** Guitar, black. Our 85 pickup built in a P90 style housing. Muscular growl & smooth lead tones, exceptional versatility.



EMG-P85-IVO

Active **P-85** Guitar, ivory. Our 85 pickup built in a P90 style housing. Muscular growl & smooth lead tones, exceptional versatility.



Retro Active
Pickups

EMG-CROSSROADS-SET-BLK

Retro Active **Crossroads** Single Coil Guitar, black. Produces Strat tones reminiscent of players like Clapton...



EMG-MAVERICK-5-SET-BLK

Retro Active **Maverick** Single Coil Guitar, black. Provides high powered surf Strat tones.



EMG-FAT55-SET-BLK

Retro Active **Fat55** Guitar, Humbucker, black. Capable of sitting back in a blues riff or rising up to the over-driven solo with ease.



EMG-FAT55-SET-ZBR

Retro Active **Fat55** Guitar, Humbucker, zebra. Capable of sitting back in a blues riff or rising up to the over-driven solo with ease.



EMG-FAT55-N-BLK

Retro Active **Fat55** Guitar, Humbucker, black. Neck Pickup, Standard String Spacing (Tune-O-Matic).



EMG-HOT70-SET-BLK

Retro Active **Hot 70** Guitar, black. Ceramic magnets in the bridge & alnico 5 in the neck producing high output tone of the late 70's.



EMG-SUPER77-SET-BLK

Retro Active **Super 77** Guitar, black. Can clean up w/ simple vol. adjust. & soft picking, aggressive play & more output will produce a dirtier sound.

X-Series Pickups



EMG-SUPER77-SET-ZBR
Retro Active **Super 77** Guitar, zebra. Can clean up w/ simple vol. adjust. & soft picking, aggressive play & more output will produce a dirtier sound.



EMG-81X
Active Guitar **81X** Humbucker, black. Tone was designed with detailed intensity, incredible amounts of high end cut, and fluid sustain.



EMG-81X-C
Active Guitar **81X** Humbucker, chrome. Our most popular pickup becomes more dynamic with the X pre-amp.



EMG-81X-BC
Active Guitar **81X** Humbucker, brushed chrome. Our most popular pickup becomes more dynamic with the X pre-amp.
Shaft length : short strat 10mm



EMG-81X-G
Active Guitar **81X** Humbucker, gold. Our most popular pickup becomes more dynamic with the X pre-amp.



EMG-81-7X
Active Guitar **81X**, 7-String, black, Humbucker. Produce a detailed tone with incredible amounts of high end cut.



EMG-81TW-X
Dual Mode Active Guitar **81TWX**, black Humbucker 81 and a separate single coil pickup in the same housing. Allow for max. flexibility.



EMG-85X
Active Guitar **85X** Humbucker, black. Alnico magnets and the X pre-amp produce a bluesy tone with a touch of overdrive.



EMG-85X-IVO
Active Guitar **85X** Humbucker, ivory. Alnico magnets and the X pre-amp produce a bluesy tone with a touch of overdrive.



EMG-85X-WHT
Active Guitar **85X** Humbucker, white. Alnico magnets and the X pre-amp produce a bluesy tone with a touch of overdrive.



EMG-85X-C
Active Guitar **85X** Humbucker, chrome. Alnico magnets and the X pre-amp produce a bluesy tone with a touch of overdrive.



EMG-85X-G
Active Guitar **85X** Humbucker, gold. Alnico magnets and the X pre-amp produce a bluesy tone with a touch of overdrive.



EMG-60X
Active Guitar **60X** Humbucker, black. Our popular rhythm pickup with the added X series pre-amp becomes more open for an almost passive feel.



EMG-60X-C
Active Guitar **60X** Humbucker, chrome. Our popular rhythm pickup with the added X series pre-amp becomes more open for an almost passive feel.



EMG-60X-G
Active Guitar **60X** Humbucker, gold. Our popular rhythm pickup with the added X series pre-amp becomes more open for an almost passive feel.



EMG-89X
Dual Mode Active Guitar **89X** Humbucker, black. The 89 dual mode pickup (SA single coil & 85 like hum) with the X series pre-amp.



EMG-SX-BLK

Active Guitar **SX** Single Coil, black. Ceramic magnets with the X series pre-amp provide more openness and clarity to your tone. For Strat.



EMG-SX-SET-BLK

Active Guitar **SX** Single Coil, black. Ceramic magnets and X Series preamp give you the tone without the hum of passive. For Strat.



EMG-SA-X

Active Guitar **SA-X** Single Coil, black. Alnico V magnet and X series pre-amp produce open, rich tone completely noiseless. For Strat.



EMG-SAV-X

Active Guitar **SAVX** Single Coil, black. Has all the tone & clarity guitar players demand with a vintage look enthusiasts will love. For Strat.



EMG-SAV-X-IVO

Active Guitar **SAVX** Single Coil, ivory. Has all the tone & clarity guitar players demand with a vintage look enthusiasts will love. For Strat.



EMG-SAV-X-RED

Active Guitar **SAVX** Single Coil, red. Has all the tone & clarity guitar players demand with a vintage look enthusiasts will love. For Strat.



EMG-SAV-X-SET

Active Guitar **SAVX** Single Coil Set, black. Based on early Strat tone this set use Alnico magnets with the X Series preamp.



EMG-SLV-X

Active Guitar **SLVX** Single Coil, black. X preamp gives more dynamic range while keeping the more string-to-string balance of the SLV. For Strat.



EMG-SLV-X-IVO

Active Guitar **SLVX** Single Coil, ivory. The X preamp gives more dynamic range while keeping the more string-to-string balance of the SLV. For Strat.



EMG-SLV-X-WHT

Active Guitar **SLVX** Single Coil, white. The X preamp gives more dynamic range while keeping the more string-to-string balance of the SLV. For Strat.



EMG-SLV-X-SET

Active Guitar **SLVX** Single Coil, black. A set of our SLV pickups with a vintage twist and our X series preamp. For Strat.



EMG-HX

Active Guitar **HX** Humbucker, black. Single coil pickup in a humbucker housing and X series pre-amp for a wide range.



EMG-707X

Active Guitar 7-String **707X**, black. Giving the voicing an organic and open tone while still maintaining the clarity and response.



EMG-808X

Active Guitar 8-String **808X**, black. Gives all the tone & presence demand in an 8 string guitar pickup w/ the added headroom of the X preamp.



EMG-909X

Active Guitar 9-String **909X**, black. Classic 707 X series humbucker in nine string housing.



EMG-H3A

Passive Guitar **H3A**, black. Alnico V magnet loaded H3 for a warmer overall tone with full top end in neck or bridge position.

Passive Pickups



EMG-H4

Passive Guitar **H4**, black. The ceramic bar loaded 81 without the “active” element for a very powerful output in the neck or bridge position. For Strat.



EMG-H4-GLD

Passive Guitar **H4**, gold. The ceramic bar loaded 81 without the “active” element for a very powerful output in the neck or bridge position. For Strat.



EMG-H4-LS-GLD

Passive Guitar **H4**, gold. The ceramic bar loaded 81 without the “active” element for a very powerful output in the neck or bridge position. For LesPaul.



EMG-H4A

Passive Guitar **H4A**, black. Versatile high output pickup with very well-balanced tones, solid bass, pronounced mids, and fat highs. For Strat.



EMG-H4A-GLD

Passive Guitar **H4A**, gold. Versatile high output pickup with very well-balanced tones, solid bass, pronounced mids, and fat highs. For Strat.



EMG-H2-B

Passive Guitar **H2**, Bridge, black. Recreate the sound & feel of the best vintage humbuckers without sacrificing presence & clarity. For Strat.



EMG-H2-N

Passive Guitar **H2**, Neck, black. Recreate the sound & feel of the best vintage humbuckers without sacrificing presence & clarity. For Strat.



EMG-S4

Passive Guitar **S4**, black. Has a beefier low-end and midrange, with the crisp highs of a traditional single-coil pickup.



Signature Sets Pickups

EMG-KHBB-SET

Active Guitar **Kirk Hammet Bone Breaker**, Set, black. Offers crisp crushing leads or smooth rounded rhythm tone at the flip of the selector switch. For Strat.



EMG-JH-SET

Active Guitar **James Hetfield**, Set, black chrome. Captures the clarity and punch of a passive pickup & still retains the legendary active tone. For Strat.



EMG-GTV-SET-RED

Active Guitar **Glenn Tipton Vengeance**, Set, red. Tight attack, knockout punch, amazing clarity, and even response across the audio spectrum.



EMG-REV-SET

Active Guitar **Prashant Aswani**, Set, white. An undeniably brilliant pair of humbuckers that delivered the clarity & definition usually found only in active pickups.



EMG-ZW-SET

Active Guitar **Zakk Wilde**, Set, 81+85 combo, black. Aggressive tone & sustain.



EMG-KFK-SET

Active Guitar **Kerry King**, Set, 81+85+PA2 combo, black. Aggressive crunch, overdrive & sick lead tones.



EMG-ALX-SET

Passive Guitar **Alexi Laiho**, Set, black. Includes our ABQ EQ/Boost. High gain, versatility, and clarity to enhance Alexi distinctive style. **Available in Floyd Rose version**



EMG-JR-DAEMONUM-SET-BLK

Retro Active Guitar **Jim Root**, Set, 81/60, Retro Active design, black. Clean high-end percussive tone.

Pro Series
Pickups



EMG-JR-DAEMONUM-SET-ZBR

Retro Active Guitar **Jim Root**, Set, 81/60, Retro Active design, zebra. Clean high-end percussive tone.



EMG-GH-SET-RED

Active Guitar **Gary Holt**, Set, red. Includes an EMG 81 in the bridge and an EMG 89R in the neck position. Gives players multiple tonal options that scream to be played.



EMG-DG20

Active Guitar **David Gilmour** system, With SA single coil, an EXG Expander for increased treble & bass frequencies + SPC presence control for Strat's earthiness and mid-range.



EMG-SL20

Active Guitar **Steve Lukather** system. This is the perfect set to go from smooth jazz to hard rock; clean and simple.



EMG-SL20-LEFT

Active Guitar **Steve Lukather** system, **Left Hand**. This is the perfect set to go from smooth jazz to hard rock; clean and simple.



EMG-KH20

Active Guitar **Kirk Hammett** system, Built around ceramic magnets for the tightest, most controlled sound with incredible versatility.

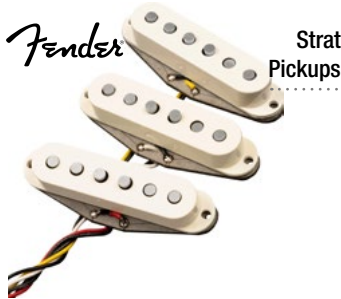

Strat
Pickups

099-2209-000

Vintera '60s Modified Stratocaster single coil pickups Set (3pcs.), Vintage White. These set has the power and articulation you need for any style of music.



099-2206-000

'50s Vintage Stratocaster single coil pickups Set (3pcs.), Vintage White. Produce the crystalline + bell-like tone that put Fender on the musical map. A classic 50's bright & open voice.



099-2205-000

'60s Vintage Stratocaster single coil pickups Set (3pcs.), Vintage White. Produce the crystalline + bell-like tone that put Fender on the musical map. Classic '60's tight & focused voice.



099-2260-000

Gen 4 Noiseless Stratocaster single coil pickups Set (3pcs.), cream. Tight low end, clearly defined high end & punchy mids that can power through any mix.



099-2290-000

Ultra Noiseless Vintage Stratocaster single coil pickups Set (3pcs.), cream. New winding tech. for livelier & more expansive tone. Vintage voice with classic bell-like chime.



099-2291-000

Ultra Noiseless Hot Stratocaster single coil pickups Set (3pcs.), cream. New winding tech. for livelier & more expansive tone. Vintage voice with classic bell-like chime.



099-2111-000

Custom Shop Texas Special Stratocaster single coil pickups Set (3pcs.), white. Feature an overwound single-coil construction that produces big Texas-blues tone.



099-2113-000

Custom Shop Fat '50s Stratocaster single coil pickups Set (3pcs.), white. Delivers enhanced bass response and an extra shot of 21st-century attitude.



099-2265-000

Custom Shop Fat '60s Stratocaster single coil pickups Set (3pcs.), white. Deliver sweet 1960s single-coil Stratocaster sound with plenty of crisp articulation.



099-2117-000

Original '57/'62 Stratocaster single coil pickups Set (3pcs.), aged white. These pickups produce round, warm tone with a sweet edge.



099-2236-000

Pure Vintage '59 Stratocaster single coil pickups Set (3pcs.). Deliver vintage-Strat sound, feel and vibe, with glistening highs and warm lows.



099-2237-000

Pure Vintage '65 Stratocaster single coil pickups Set (3pcs.). Give you the powerful, clean & clear surf rock tones of mid-'60s Stratocaster guitars.



099-2114-000

Custom Shop Custom '69 Stratocaster single coil pickups Set (3pcs.), white. Produce the full, punchy tone that defined rock in the late '60s.



099-2385-000

Pure Vintage '57 Stratocaster single coil pickups Set (3pcs.), white. Percussive lows, round mids and smooth high-end chime produce perfect medium-output late-'50's punch.



099-2131-000

Tex-Mex Stratocaster single coil pickups Set (3pcs.), white. Offer increased output, sparkling highs and attention-grabbing warm tone.

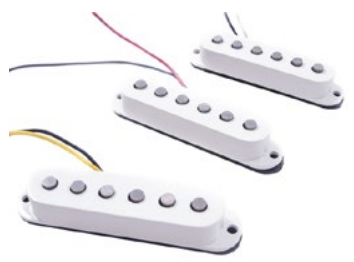

099-2222-000

Deluxe Drive Stratocaster single coil pickups Set (3pcs.), white. Are supercharged with the highest output of all our single-coil pickups.



099-2105-000

Hot Noiseless Stratocaster single coil pickups Set (3pcs.), aged white. Combines warmth & punch with cutting bluesy articulation, with a screaming high-gain.



099-2115-000

Vintage Noiseless Stratocaster single coil pickups Set (3pcs.), aged white. Produce all the brilliant clarity & harmonic attributes of vint. single-coil.



Tele
Pickups

099-2204-000

'50s Vintage Telecaster single coil pickups Set (2pcs.). Produce the crisp, snarling tone that put Fender on the musical map. Detailed warmth found in early 50's Telecasters.



099-2292-000

Ultra Noiseless Vintage Telecaster, single coil pickups Set (2pcs.). New winding tech. for livelier & more expansive tone. Have the twang and bite from vintage Tele with no hum.



099-2261-000

Gen 4 Noiseless Telecaster single coil pickups Set (2pcs.). Offering crisp, clear cleans as well as gigantic overdriven tones for pure rock power.



099-2109-000

Custom Shop '51 Nocaster Telecaster single coil pickups Set (2pcs.). Impart tight low end and clear, balanced midrange. Alnico 3.



099-2386-000

Pure Vintage '51 Telecaster single coil pickups Set (2pcs.). Impart tight low end and clear, balanced midrange. Alnico 5 magnets.



099-2371-000

Cobalt Chrome Telecaster single coil pickups Set (2pcs.). Voiced by tone guru Tim Shaw. Help eliminate 60-cycle hum, unlock your Telecasters full tonal potential.



099-2119-000

Original Vintage Telecaster single coil pickups Set (2pcs.). Provide extremely accurate 1950s Tele twang, with the classic warmth & edge.



099-2234-000

Pure Vintage '64 Telecaster single coil pickups Set (2pcs.). Offer hotter, stronger Tele twang that's crystal clear & versatile enough.



099-2121-000

Custom Shop Texas Spec. Telecaster single coil pickups Set (2pcs.). Produce blistering hot output, along with noticeable presence & midrange.



099-2263-000

Tex-Mex Telecaster single coil pickups Set (2pcs.). Tight, clear bass, crisp highs and maximum output that easily kicks an amp into overdrive.



099-2223-000

Deluxe Drive Telecaster single coil pickups Set (2pcs.). They are supercharged with the highest output of all our single-coil pickups.



099-2116-000

Vintage Noiseless Telecaster single coil pickups Set (2pcs.). Produce the brilliant single-coil clarity, definition and twang of a vintage 1960s Tele without the hum.



099-2215-000

Custom Shop Twisted Telecaster single coil pickups Set (2pcs.). Deliver hot high-output Telecaster guitar tone with a dash of sparkling Strat. guitar character.

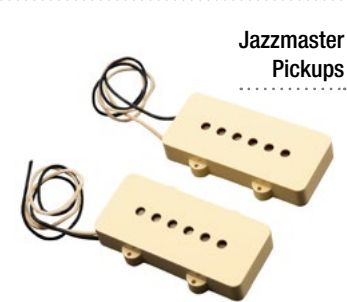

Jazzmaster Pickups

099-2210-000

Vintera '60s Modified Jazzmaster, aged white, set. Revoiced for hotter output and modern tones, while retaining the chime and jangle that put the Jazzmaster® on the map.



099-2239-000

Pure Vintage '65 Jazzmaster, aged white. No other pickups project the iconoclastic clean-and-clear vintage-style tone, edgy snarl and undeniable texture of the 1965 Jazzmaster.



099-2238-000

Pure Vintage '65 Jaguar. Clean & clear sound of the mid-'60s, same liquid-hot tone & snarling angular attitude as the ax that sparked surf rock.

Jaguar Pickups



Pre-Wired Pickups

099-2346-500

Pre-Wired Strat Pickguard, Hot Noiseless SSS, tortoise shell, 11-Hole. Deliver scorching output, flush-mount pole pieces for even string response,



099-2341-506

Pre-Wired Strat Pickguard, Custom '69 SSS, black, 11-Hole. Warm vintage-style tones, staggered pole pcs for balanced output, alnico 5 magnets for focus & enhanced dynamics.

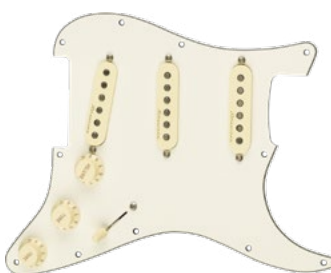

099-2344-509

Pre-Wired Strat Pickguard, Vintage Noiseless SSS, Parchment, 11-Hole. Deliver smooth, balanced tone. Alnico 2 magnets create warmer attack & less-aggressive midrange



099-2342-506

Pre-Wired Strat Pickguard, Texas Special SSS, black, 11-Hole. Warm vintage-style tones, balanced output, focus & enhanced dynamics, reverse-wound mid-pickup to eliminate hum.

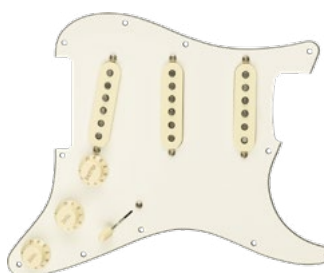

099-2345-509

Pre-Wired Strat Pickguard, Original '57/'62 SSS, Parchment, 11-Hole. Formvar magnet wire for bright, glassy tone. Staggered hand-beveled pole pcs for smooth, balanced tone.



Misc.

005-7577-000

Stratocaster® Mid Boost Kit. Mid-boost kit upgrades nearly any Strat pickups with active electronics. Contains PCB, all controls diagram.

golds

Humbuckers



M213

Standard Humbucker, black. Ceramic magnets, very good assertive sound quality!

Single Coil Pickups



MP112

Standard «Hot» Pickup for Strat, black. Ceramic magnets under pole pieces, nice treble sound.



PT000

Standard Pickup for Tele, black, Bridge. Size 24.5 x 36 x 72mm.

GRETSCH



006-0999-000

Pickups, Single Coil, **Dynasonic**, Bridge, chrome. Feature shimmering highs and a rich, full bass response. Individually adjustable pole-pieces



006-1001-000

Pickups, Single Coil, **Dynasonic**, Neck, chrome. Feature shimmering highs and a rich, full bass response. Individually adjustable pole-pieces



006-2880-100

Pickups Humbucker, **Filtertron**, Neck chrome. Filter out the electronic hum while adding a warmer tone, + a significant increase in output & sustain.



006-2876-100

Pickups Humbucker, **Filtertron**, Bridge, chrome. Filter out the electronic hum while adding a warmer tone, + a good increase in output & sustain.



006-2875-100

Pickups Humbucker, **Filtertron**, Bridge, gold. Filter out the electronic hum while adding a warmer tone, + a good increase in output & sustain.



006-2879-100

Pickups Humbucker, **Filtertron**, Neck, gold. Filter out the electronic hum while adding a warmer tone, + a good increase in output & sustain.

KLUSON

Humbuckers



PF1BB

Pickup Humbucker, **Creambucker**, Bridge, black. Alnico magnets & the finest, historically correct wire with the correct diameter + isolation thickness.



PF1NB

Pickup Humbucker, **Creambucker**, Neck, black. Alnico magnets & the finest, historically correct wire with the correct diameter + isolation thickness.



PF1BK

Pickup Humbucker, **Creambucker**, Bridge, cream. Alnico magnets & the finest, historically correct wire with the correct diameter + isolation thickness.



PF1NK

Pickup Humbucker, **Creambucker**, Neck, cream. Alnico magnets & the finest, historically correct wire with the correct diameter + isolation thickness.



PF1BZ

Pickup Humbucker, **Creambucker**, Bridge, zebra. Alnico magnets & the finest, historically correct wire with the correct diameter + isolation thickness.



PF1NZ

Pickup Humbucker, **Creambucker**, Neck, zebra. Alnico magnets & the finest, historically correct wire with the correct diameter + isolation thickness.



PF1BG

Pickup Humbucker, **Creambucker**, Bridge, gold. Alnico magnets & the finest, historically correct wire with the correct diameter + isolation thickness.



PF1NG

Pickup Humbucker, **Creambucker**, Neck, gold. Alnico magnets & the finest, historically correct wire with the correct diameter + isolation thickness.



PF1BN

Pickup Humbucker, **Creambucker**, Bridge, nickel. Alnico magnets & the finest, historically correct wire with the correct diameter + isolation thickness.



PF1NN

Pickup Humbucker, **Creambucker**, Neck, nickel. Alnico magnets & the finest, historically correct wire with the correct diameter + isolation thickness.



PF2NB

Pickup Humbucker, **Sweetbucker**, Neck, black. Precise attack. Ideal in neck position for clean or slightly distorted jazz- or blues-sounds.



PF4BB

Pickup Humbucker, **Jay Screamer**, Bridge, black. A forceful bridge pickup with great output, balanced mids & singing harmonics.

P90 pickups



PF6BB

Pickup Humbucker, **Troublebucker**, Bridge, black. More power and the necessary bite for the Harder Style. Fat but never slushy!



P90BB

Pickup **Vintage P90**, Bridge, black. Known as the most tasteful reproduction of the old P-90 sounds!



P90C

Pickup **Vintage P90**, Neck, chrome. Known as the most tasteful reproduction of the old P-90 sounds!



P910B

Pickup **Vintage P90 Soapbar**, Bridge. Known as the most tasteful reproduction of the old P-90 sounds. Come with black and cream covers!

Single Coil pickups



P910N

Pickup **Vintage P90 Soapbar**, Neck. Known as the most tasteful reproduction of the old P-90 sounds. Come with black and cream covers!



PSC01

Pickup Single Coil, **Kluson Vintage '56 Lead**, Bridge. Exact reproductions of those good old pickups with great open '56 sound! For Strat.



PSC00

Pickup Single Coil, **Kluson Vintage '56**, Neck. Exact reproductions of those good old pickups with great open '56 sound! For Strat.



PSCR0

Pickup Single Coil, **Kluson Vintage '56 reserve**, Middle. Exact reproductions of those good old pickups with great open '56 sound! For Strat.



PSSET

Pickup Single Coil, **Kluson Vintage '56 Set**, 1 PSC01 (bridge), 1 PSCRO (middle), 1 PSC00 (neck). Great open '56 sound! For Strat.



PSX01

Pickup Single Coil, **Kluson Texas Blues**, Bridge. Slightly more output - slightly more mids - slightly cooler! For Strat.



PSX00

Pickup Single Coil, **Kluson Texas Blues**, Neck. Slightly more output - slightly more mids - slightly cooler! For Strat.



PSXR0

Pickup Single Coil, **Kluson Texas Blues reserve**, Middle. Slightly more output - slightly more mids - slightly cooler! For Strat.



PSXSET

Pickup Single Coil, **Kluson Texas Blues Set**. (PSX00 + PSXR0 + PSX01). Slightly more output - slightly more mids - slightly cooler! For Strat.



PTL00

Pickup Single Coil, **Kluson Vintage Lead**, Bridge. Alnico magnets, relatively thick coated wire, great open 50s sound. For Tele.



PTL01

Pickup Single Coil, **Kluson Vintage Neck**. Alnico magnets, relatively thick coated wire, great open 50s sound. For Tele.



PTSET

Pickup Single Coil, **Kluson Vintage Set**. 1 PTL00 plus 1 PTL01. Alnico magnets, relatively thick coated wire, great open 50s sound. For Tele.

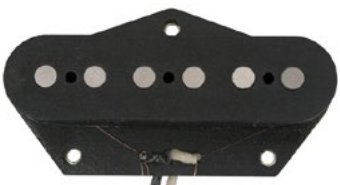

PTX00

Pickup Single Coil, **Kluson Texas Blues**, Bridge. Slightly more output - slightly more mids - slightly cooler! For Tele.



PTX01

Pickup Single Coil, **Kluson Texas Blues**, Neck. Slightly more output - slightly more mids - slightly cooler! For Tele.



PTXSET

Pickup Single Coil, **Kluson Texas Blues Set**. 1 PTX00 plus 1 PTX01. Slightly more output - slightly more mids - slightly cooler! For Tele.



PSGFBN

Pickup Single Coil, **GoldFoil Pickup**, bridge. Sounds extremely open and brilliant with powerful. Standard humbucker dimensions.



PSGFNN

Pickup Single Coil, **GoldFoil Pickup**, neck. Sounds extremely open and brilliant with powerful. Standard humbucker dimensions.



PSSFBN

Pickup Single Coil, **SilverFoil Pickup**, bridge. Sounds extremely open and brilliant with powerful. Standard humbucker dimensions.



PSSFNN

Pickup Single Coil, **SilverFoil Pickup**, neck. Sounds extremely open and brilliant with powerful. Standard humbucker dimensions.

Seymour Duncan Vintage Humbuckers

HUMBUCKERS



SH-1-N-BLK

Humbucker **59' Model**, Neck, black Versatile P.A.F.-type humbucker. Great for country, jazz, blues, funk, classic rock and heavy rock.



SH-1-N-ZBR

Humbucker 59' Model, Neck, zebra Versatile P.A.F.-type humbucker. Great for country, jazz, blues, funk, classic rock and heavy rock.



SH-1-N-NKL

Humbucker 59' Model, Neck, nickel cover. Versatile P.A.F.-type humbucker. Great for country, jazz, blues, funk, classic rock and heavy rock.



SH-1-N-GLD

Humbucker 59' Model, Neck, gold cover. Versatile P.A.F.-type humbucker. Great for country, jazz, blues, funk, classic rock and heavy rock.



SH-1-N-BLK-4C

Humbucker 59' Model 4 conductors, Neck, black. Versatile P.A.F.-type humbucker. Great for country, jazz, blues, classic rock & heavy rock.



SH-1-N-ZBR-4C

Humbucker 59' Model 4 conductors, Neck, zebra. Versatile P.A.F.-type humbucker. Great for country, jazz, blues, classic rock & heavy rock.



SH-1-N-NKL-4C

Humbucker 59' Model 4 conductors, Neck, nickel Cover. Versatile P.A.F.-type humbucker. Great for country, jazz, blues, classic rock & heavy rock.



SH-1-N-GLD-4C

Humbucker 59' Model 4 conductors, Neck, gold Cover. Versatile P.A.F.-type humbucker. Great for country, jazz, blues, classic rock & heavy rock.



SH-1-N-WHT-4C

Humbucker 59' Model 4 conductors, Neck, white. Versatile P.A.F.-type humbucker. Great for country, jazz, blues, classic rock and heavy rock.



SH-1-N-BLK-7

Humbucker 59' Model 7-String, Neck, black. Versatile P.A.F.-type humbucker. Great for country, jazz, blues, classic rock & heavy rock.



SH-1-B-BLK

Humbucker 59' Model, Bridge, black Versatile P.A.F.-type humbucker. Great for country, jazz, blues, classic rock and heavy rock.



SH-1-B-ZBR

Humbucker 59' Model, Bridge, zebra Versatile P.A.F.-type humbucker. Great for country, jazz, blues, classic rock and heavy rock.



SH-1-B-NKL

Humbucker 59' Model, Bridge, nickel cover. Versatile P.A.F.-type humbucker. Great for country, jazz, blues, classic rock and heavy rock.



SH-1-B-GLD

Humbucker 59' Model, Bridge, gold cover. Versatile P.A.F.-type humbucker. Great for country, jazz, blues, classic rock and heavy rock.



SH-1-B-WHT

Humbucker 59' Model, Bridge, white Versatile P.A.F.-type humbucker. Great for country, jazz, blues, classic rock and heavy rock.



SH-1B-NH

Humbucker 59' Model for Epiphone NightHawk, Bridge. Resonant Peak : 6kHz - DC Resistance: 8.130hm



SH-1-B-BLK-4C

Humbucker 59' Model 4 conductors, Bridge, black. Versatile P.A.F.-type humbucker. Great for country, jazz, blues, classic rock & heavy rock.



SH-1-B-ZBR-4C

Humbucker **59' Model 4 conductors**, Bridge, zebra. Versatile P.A.F.-type humbucker. Great for country, jazz, blues, classic rock & heavy rock.



SH-1-B-NKL-4C

Humbucker **59' Model 4 conductors**, Bridge, nickel Cover. Versatile P.A.F.-type humbucker. Great for country, jazz, blues, classic & heavy rock.



SH-1-B-BLK-7

Humbucker **59' Model 7-String**, Bridge, Black. Versatile P.A.F.-type humbucker. Great for country, jazz, blues, classic rock & heavy rock.



59-SET

Humbucker **59' Model**, Bridge, black. SH-1-B-BLK + SH-1-N-BLK. Great for country, jazz, blues, funk, classic rock & heavy rock.



SH-55-N-NKL

Humbucker **Seth Lover**, Neck, nickel. Gives you warm airy, open tone. Low end warmth with a smooth but articulate top end.



SH-55-N-GLD

Humbucker **Seth Lover**, Neck, gold. Gives you warm airy, open tone. Low end warmth with a smooth but articulate top end.



SH-55-B-NKL

Humbucker **Seth Lover**, Bridge, nickel. Gives you warm airy, open tone. Low end warmth with a smooth but articulate top end.



SH-55-B-GLD

Humbucker **Seth Lover**, Bridge, gold. Gives you warm airy, open tone. Low end warmth with a smooth but articulate top end.



APH-1-N-BLK

Humbucker **Alnico II Pro**, Neck, black. Create a warm, sweet tone that is smooth and full, with tons of natural sustain.



APH-1-N-ZBR

Humbucker **Alnico II Pro**, Neck, zebra. Create a warm, sweet tone that is smooth and full, with tons of natural sustain.



APH-1-N-NKL

Humbucker **Alnico II Pro**, Neck, nickel Cover. Create a warm, sweet tone that is smooth and full, with tons of natural sustain.



APH-1-N-GLD

Humbucker **Alnico II Pro**, Neck, gold Cover. Create a warm, sweet tone that is smooth and full, with tons of natural sustain.



APH-1-N-WHT

Humbucker **Alnico II Pro**, Neck, white. Create a warm, sweet tone that is smooth and full, with tons of natural sustain.



APH-1-B-BLK

Humbucker **Alnico II Pro**, Bridge, black. Create a warm, sweet tone that is smooth and full, with tons of natural sustain.



APH-1-B-ZBR

Humbucker **Alnico II Pro**, Bridge, zebra. Create a warm, sweet tone that is smooth and full, with tons of natural sustain.



APH-1-B-NKL

Humbucker **Alnico II Pro**, Bridge, nickel Cover. Create a warm, sweet tone that is smooth and full, with tons of natural sustain.



APH-1-B-GLD

Humbucker **Alnico II Pro**, Bridge, gold Cover. Create a warm, sweet tone that is smooth and full, with tons of natural sustain.



SH-PG1-N-BLK

Humbucker **Pearly Gates**, Neck, black. P.A.F. style humbucker with a ton of rude Texas attitude for a neck tone that stays warm and focused.



SH-PG1-N-ZBR

Humbucker **Pearly Gates**, Neck, zebra. P.A.F. style humbucker with a ton of rude Texas attitude for a neck tone that stays warm and focused.



SH-PG1-N-NKL

Humbucker **Pearly Gates**, Neck, nickel Cover. P.A.F. style humbucker with a ton of rude Texas attitude for a neck tone that stays warm and focused.



SH-PG1-B-BLK

Humbucker **Pearly Gates**, Bridge, black. P.A.F. style humbucker with a ton of rude Texas attitude for a neck tone that stays warm and focused.



SH-PG1-B-ZBR

Humbucker **Pearly Gates**, Bridge, zebra. P.A.F. style humbucker with a ton of rude Texas attitude for a neck tone that stays warm and focused.



SH-PG1-B-NKL

Humbucker **Pearly Gates**, Bridge, nickel Cover. P.A.F. style humbucker with a ton of rude Texas attitude for a neck tone that stays warm & focused.



SH-PG1-B-GLD

Humbucker **Pearly Gates**, Bridge, gold Cover. P.A.F. style humbucker with a ton of rude Texas attitude for a neck tone that stays warm & focused.



ZS-1-B

Humbucker **Zephyr**, Bridge, black. Tone with unprecedented treble clarity, vibrant harmonics & incredible dynamics. More highs, fuller yet tighter lows & fatter mids.



ZS-1-N

Humbucker **Zephyr**, Neck, black. Tone with unprecedented treble clarity, vibrant harmonics & incredible dynamics. More highs, fuller yet tighter lows & fatter mids.



SH-16-NKL

Humbucker **59 Custom Hybrid**, Bridge, nickel cover. Uses one coil from the 59 Model bridge and one coil from the higher output Duncan Custom model.



SH-18-B-GLD

Humbucker **Whole Lotta**, Bridge, gold cover. Very slight natural compression + sustain to your sound. The rough cast magnets add warmth & balance so everything sounds bigger.



SH-18-N-BLK

Humbucker **Whole Lotta**, Neck, black. Very slight natural compression + sustain to your sound. The rough cast magnets add warmth & balance so everything sounds bigger.



SH-18N-Z

Humbucker **Whole Lotta**, Neck, zebra. Very slight natural compression + sustain to your sound. The rough cast magnets add warmth & balance so everything sounds bigger.



SH-18S-BLK

Humbucker **Whole Lotta**, Set, black. Very slight natural compression + sustain to your sound. The rough cast magnets add warmth & balance so everything sounds bigger.



SNSB-N

Humbucker **Saturday Night Special**, Bridge, nickel cover. Plenty of bite for overdriven late 70s tones, without the 'wooliness' of trad. vintage pickups.

Modern
Humbuckers



SNSB-G

Humbucker **Saturday Night Special**, Bridge, gold cover. Plenty of bite for overdriven late 70s tones, without the 'wooliness' of trad. vintage pickups.



SNSN-N

Humbucker **Saturday Night Special**, Neck, nickel cover. Plenty of bite for overdriven late 70s tones, without the 'wooliness' of trad. vintage pickups.



SNSN-G

Humbucker **Saturday Night Special**, Neck, gold cover. Plenty of bite for overdriven late 70s tones, without the 'wooliness' of trad. vintage pickups.



SH-3-BLK

Humbucker **The Stag Mag**, Bridge, black. Uses staggered alnico 2 rod magnets instead of the traditional bar magnet, for Strat tone when split.



SH-3-WHT

Humbucker **The Stag Mag**, Bridge, white. Uses staggered alnico 2 rod magnets instead of the traditional bar magnet, for Strat tone when split.



SHPR-1-B

Humbucker **P-Rails**, Bridge, black cover. Combines a Hot Rails coil with our Vintage P90 to give you unmatched tonal variety.



SHPR-1-B-CRM

Humbucker **P-Rails**, Bridge, cream cover. Combines a Hot Rails coil with our Vintage P90 to give you unmatched tonal variety.



SHPR-1-N

Humbucker **P-Rails**, Neck, black cover. Combines a Hot Rails coil with our Vintage P90 to give you unmatched tonal variety.



SHPR-1-N-CRM

Humbucker **P-Rails**, Neck, cream cover. Combines a Hot Rails coil with our Vintage P90 to give you unmatched tonal variety.



SHPR-2-B-BLK

Humbucker **P-Rails Hot**, Bridge, black cover. A hotter, more aggressive version of our P-Rails humbucker with alnico 8 or added punch.



SHPR-2-B-CRM

Humbucker **P-Rails Hot**, Bridge, cream cover. A hotter, more aggressive version of our P-Rails humbucker with alnico 8 or added punch.



SHPR-2-B-WHT

Humbucker **P-Rails Hot**, Bridge, white cover. A hotter, more aggressive version of our P-Rails humbucker with alnico 8 or added punch.



SH-2-B-BLK

Humbucker **Jazz Model**, Bridge, black. Has a bright, clear tone that is great for clean rhythm playing, or for brightening up a dark sounding guitar.



SH-2-B-NKL

Humbucker **Jazz Model**, Bridge, nickel cover. Bright, clear tone that is great for clean rhythm playing, or for brightening up a dark sounding guitar.



SH-2-B-WHT

Humbucker **Jazz Model**, Bridge, white. Has a bright, clear tone that is great for clean rhythm playing, or for brightening up a dark sounding guitar.



SH-2-N-BLK

Humbucker **Jazz Model**, Neck, black. Has a bright, clear tone that is great for clean rhythm playing, or for brightening up a dark sounding guitar.



SH-2-N-ZBR

Humbucker **Jazz Model**, Neck, zebra. Has a bright, clear tone that is great for clean rhythm playing, or for brightening up a dark sounding guitar.



SH-2-N-NKL

Humbucker **Jazz Model**, Neck, nickel Cover. Has a bright, clear tone that is great for clean rhythm playing, or for brightening up a dark sounding guitar.



SH-2-N-GLD

Humbucker **Jazz Model**, Neck, gold Cover. Has a bright, clear tone that is great for clean rhythm playing, or for brightening up a dark sounding guitar.



SH-2-N-WHT

Humbucker **Jazz Model**, Neck, white. Has a bright, clear tone that is great for clean rhythm playing, or for brightening up a dark sounding guitar.



SH-2-N-BLK-7

Humbucker **Jazz Model**, 7-String Neck, black. A bright humbucker with vintage output that gives you a clear, articulate neck tone.



JB-JAZZ-SET

Humbucker **'Hot Rodded**, Set, black. The JB and Jazz Models make for a versatile combination that will breathe life into any guitar.



SH-4-BLK

Humbucker **JB Model**, Bridge, black. The ultimate hot-rodged humbucker. The low end is full and powerful, the highs are crisp and detailed.



SH-4-ZBR

Humbucker **JB Model**, Bridge, zebra. The ultimate hot-rodged humbucker. The low end is full and powerful, the highs are crisp and detailed.



SH-4-NKL

Humbucker **JB Model**, Bridge, nickel cover. The ultimate hot-rodged humbucker. The low end is full and powerful, the highs are crisp and detailed.



SH-4-GLD

Humbucker **JB Model**, Bridge, gold cover. The ultimate hot-rodged humbucker. The low end is full and powerful, the highs are crisp and detailed.



SH-4-WHT

Humbucker **JB Model**, Bridge, white. The ultimate hot-rodged humbucker. The low end is full and powerful, the highs are crisp and detailed.



SH-4-NH

Humbucker **JB Model NightHawk**, Bridge, black. The ultimate hot-rodged humbucker for Epiphone NightHawk. The low end is full & powerful, the highs are crisp & detailed.



SH-4-BLK-7

Humbucker **JB Model**, 7-String Bridge, black. The ultimate hot-rodged humbucker. The low end is full & powerful, the highs are crisp & detailed.



SH-10-B-BLK

Humbucker **Full Shred**, Bridge, black. Delivers a clear, focused hum. tone with a nicely balanced treble & bass response + a backed off midrange.



SH-10-B-ZBR

Humbucker **Full Shred**, Bridge, zebra. Delivers a clear, focused hum. tone with a nicely balanced treble & bass response + a backed off midrange.



SH-10-B-WHT

Humbucker **Full Shred**, Bridge, white. Delivers a clear, focused hum. tone with a nicely balanced treble & bass response + a backed off midrange.



SH-10-N-BLK

Humbucker **Full Shred**, Neck, black. Delivers a clear, focused hum. tone with a nicely balanced treble & bass response + a backed off midrange.



SH-10-N-ZBR

Humbucker **Full Shred**, Neck, zebra. Delivers a clear, focused hum. tone with a nicely balanced treble & bass response + a backed off midrange.



SH-10-N-WHT

Humbucker **Full Shred**, Neck, white. Delivers a clear, focused hum. tone with a nicely balanced treble & bass response + a backed off midrange.



SH-12-BLK

Humbucker **Screamin' Demon**, Bridge, black. A medium output humb. designed to deliver crisp 80s sizzle with a scooped midrange.

High Output
Humbuckers



SH-12-ZBR

Humbucker **Screamin' Demon**, Bridge, zebra. A medium output humb. designed to deliver crisp 80s sizzle with a scooped midrange.



SH-6-B-BLK

Humbucker **Duncan Distortion**, Bridge, black. Great for hard-hitting, crunchy rhythms, and the lead tones scream with wild harmonics.



SH-6-B-ZBR

Humbucker **Duncan Distortion**, Bridge, zebra. Perfect for rock and metal players. Great for hard-hitting, crunchy rhythms, and the lead tones scream with wild harmonics.



SH-6-B-NKL

Humbucker **Duncan Distortion**, Bridge, nickel Cover. Perfect for rock and metal players. Great for hard-hitting, crunchy rhythms, and the lead tones scream with wild harmonics.



SH-6-B-WHT

Humbucker **Duncan Distortion**, Bridge, white. Perfect for rock and metal players. Great for hard-hitting, crunchy rhythms, and the lead tones scream with wild harmonics.



SH-6-N-BLK

Humbucker **Duncan Distortion**, Neck, black. Perfect for rock and metal players. Great for hard-hitting, crunchy rhythms, and the lead tones scream with wild harmonics.



SH-6-N-ZBR

Humbucker **Duncan Distortion**, Neck, zebra. Perfect for rock and metal players. Great for hard-hitting, crunchy rhythms, and the lead tones scream with wild harmonics.



SH-6-N-NKL

Humbucker **Duncan Distortion**, Neck, nickel Cover. Perfect for rock and metal players. Great for hard-hitting, crunchy rhythms, and the lead tones scream with wild harmonics.



SH-6-N-WHT

Humbucker **Duncan Distortion**, Neck, white. Perfect for rock and metal players. Great for hard-hitting, crunchy rhythms, and the lead tones scream with wild harmonics.



SH-6-SET

Humbucker **Duncan Distortion Mayhem**, Set, black. Perfectly suited for aggressive rock and metal players.



SH-6B-P-SB-7

Humbucker **Duncan Distortion**, 7-String, Bridge, black. Perfectly suited for extended range guitars.



SH-6N-P-SB-7

Humbucker **Duncan Distortion**, 7-String, Neck, black. Perfectly suited for extended range guitars.



SH-5-BLK

Humbucker **Duncan Custom**, Bridge, black. A custom overwound P.A.F. with moderate output, perfectly voiced for supreme blues, rock & metal.



SH-5-ZBR

Humbucker **Duncan Custom**, Bridge, zebra. A custom overwound P.A.F. with moderate output, perfectly voiced for supreme blues, rock & metal.



SH-5-WHT

Humbucker **Duncan Custom**, Bridge, white. A custom overwound P.A.F. with moderate output, perfectly voiced for supreme blues, rock & metal.



SH-5-7-BLK

Humbucker **Duncan Custom**, Bridge, 7-String, black. A custom overwound P.A.F. with moderate output, perfectly voiced for blues, rock & metal.



SH-11-BLK

Humbucker **Custom Custom**, black. Medium hot output + an alnico 2 bar magnet, it delivers a full, fat sound with singing highs and buttery lows.



SH-11-ZBR

Humbucker **Custom Custom**, zebra. Medium hot output + an alnico 2 bar magnet, it delivers a full, fat sound with singing highs and buttery lows.



SH-11-NKL

Humbucker **Custom Custom**, nickel Cover. Medium hot output combined with the warmth of an alnico 2 bar magnet, it delivers a full, fat sound with singing highs and buttery lows.



SH-11-GLD

Humbucker **Custom Custom**, gold Cover. Medium hot output combined with the warmth of an alnico 2 bar magnet, it delivers a full, fat sound with singing highs and buttery lows.



SH-11-WHT

Humbucker **Custom Custom**, white. Medium hot output combined with the warmth of an alnico 2 bar magnet, it delivers a full, fat sound with singing highs and buttery lows.



SH-14-BLK

Humbucker **Custom 5**, Bridge, black. If the 59 Model bridge humbucker was twice as loud, it would be a Custom 5. Scooped mids, even bass & treble, and high output.



SH-14-GLD

Humbucker **Custom 5**, Bridge, gold Cover. If the 59 Model bridge humbucker was twice as loud, it would be a Custom 5. Scooped mids, even bass & treble, and high output.



SH-BW-B-BLK

Humbucker **Black Winter**, Bridge, black. Created for the most frigid Black Metal, Death Metal, or any other extreme style.



SH-BW-N-BLK

Humbucker **Black Winter**, Neck, black. Created for the most frigid Black Metal, Death Metal, or any other extreme style.



SH-BW-SET

Humbucker **Black Winter**, Set, black. Created for the most frigid Black Metal, Death Metal, or any other extreme style.



SENT-BLK-6STR

Humbucker **Sentient**, Passive, Neck, black. Whether run clean or through the filthiest of high gain channels, it offers the articulation demanded.



SNT-N-P-B-7STR

Humbucker **Sentient**, Passive, 7-String, Neck, black. Delivers great neck tone for extended range guitars.



SNT-N-P-BMT-7STR

Humbucker **Sentient**, Passive, 7-String, Neck, black Metal. Delivers great neck tone for extended range guitars.



NGL-B-P-6STR

Humbucker **Nazgûl**, Passive, Bridge, black. The Nazgûl's searing highs, grinding mids and tight bass define the sound of modern metal.



NGL-B-P-7STR

Humbucker **Nazgûl**, Passive, 7-String, Bridge, black. The Nazgûl's searing highs, grinding mids and tight bass define the sound of modern metal.



NGL-B-P-BMT-7STR

Humbucker **Nazgûl**, Passive, 7-String, Bridge, black Metal. Searing highs, grinding mids and tight bass define the sound of modern metal.



NGL-SNT-SET-P-7STR

Humbucker **Nazgûl+Sentient**, Passive, 7-String, Set, black Metal. Searing highs, grinding mids and tight bass define modern metal.



PGS-B-P-7STR

Humbucker **Pegasus**, Passive, 7-String, Bridge, black. A medium output, articulate, bridge pickup created specifically for progressive metal.



PGS-B-P-BMT-7STR

Humbucker **Pegasus**, Passive, 7-String, Bridge, black Metal. A medium output, articulate, bridge pickup created specifically for progressive metal.



PGS-SNT-SET-P-7STR

Humbucker **Pegasus+Sentient**, Passive, 7-String, Set, black Metal. This calibrated set delivers the perfect blend of articulation and aggression.

**Aggressive
Humbuckers**



SH-8-B-BLK

Humbucker **Invader**, Bridge, black. High output with a huge sound, has a look and sound like no other pickup. Loud, vicious, and unapologetic.



SH-8-B-WHT

Humbucker **Invader**, Bridge, white. High output with a huge sound, has a look and sound like no other pickup. Loud, vicious, and unapologetic.



SH-8-N-BLK

Humbucker **Invader**, Neck, black. High output with a huge sound, has a look and sound like no other pickup. Loud, vicious, and unapologetic.



SH-8-N-WHT

Humbucker **Invader**, Neck, white. High output with a huge sound, has a look and sound like no other pickup. Loud, vicious, and unapologetic.



SH-8-B-BLK-7

Humbucker **Invader**, Bridge, 7-String, black. High output with a huge sound, has a look and sound like no other pickup. Loud, vicious, & unapologetic.



SH-8-N-BLK-7

Humbucker **Invader**, Neck, 7-String, black. High output with a huge sound, has a look and sound like no other pickup. Loud, vicious, & unapologetic.



SH-15-BLK

Humbucker **Alternative 8**, Bridge, black. Featuring a custom wind & a high-powered Alnico 8 magnet for ceramic-style clarity with warmth.



SH-15-NCK

Humbucker **Alternative 8**, Bridge, nickel. Featuring a custom wind & a high-powered Alnico 8 magnet for ceramic-style clarity with warmth.

Active
Humbuckers



SH-15-GLD

Humbucker **Alternative 8**, Bridge, gold. Featuring a custom wind & a high-powered Alnico 8 magnet for ceramic-style clarity with warmth.



SH-6B-A-SB-7

Humbucker **Duncan Distortion Active Mount**, 7-String, Bridge, black. Perfectly suited for extended range guitars.



SH-6N-A-SB-7

Humbucker **Duncan Distortion Active Mount**, 7-String, Neck, black. Perfectly suited for extended range guitars.



SENT-N-A-B-7STR

Humbucker **Sentient**, Active, 7-String, Neck, black. Delivers great neck tone for extended range guitars.



NGL-B-A-SB-7STR

Humbucker **Nazgûl**, Active, 7-String, Bridge, black Metal. Searing highs, grinding mids and tight bass define the sound of modern metal.



SH-8-N-BLK-7

Humbucker **Invader**, Active, Bridge, 7-String, black. High output with a huge sound, great look. Sounds loud, vicious, & unapologetic.



AHB-1-B-BLK

Humbucker **Blackouts Active**, Bridge, black. The original active Blackouts bridge humbucker delivers the high output and massive crunch required for a full metal onslaught.



AHB-1-N-BLK

Humbucker **Blackouts Active**, Neck, black. Delivers the high output and massive crunch required for a full metal onslaught.



AHB-1-SET

Humbucker **Blackouts Metal Active**, Set, black. A set of our active Blackouts humbuckers will turn any guitar into a heavy metal behemoth.



AHB-1-SET-GLD

Humbucker **Blackouts Metal Active**, Set, gold. A set of our active Blackouts humbuckers will turn any guitar into a heavy metal behemoth.



AHB-1B-7-PHASE-1

Humbucker **Blackouts Active**, 7-String, Bridge, black. Duncan / Dimarzio 7-string size.



AHB-1N-7-PHASE-1

Humbucker **Blackouts Active**, 7-String, Neck, black. Duncan / Dimarzio 7-string size.



AHB-1S-7-PHASE-1

Humbucker **Blackouts Active**, 7-String, Set, black. Duncan / Dimarzio 7-string size.



AHB-1B-7-PHASE-2

Humbucker **Blackouts Active**, 7-String, Bridge, black. EMG 707 size.



AHB-1N-7-PHASE-2

Humbucker **Blackouts Active**, 7-String, Neck, black. EMG 707 size.



AHB-1S-7-PHASE-2

Humbucker **Blackouts Active**, 7-String, Set, black. EMG 707 size.

Mini-Humbuckers



AHB-1S-8STRING

Humbucker **Blackouts Active**, 8-String, Set, black. Take your active hum. equipped extended range instr. to a new level of lucid aggression.



AHB-2B-BLK

Humbucker **Blackouts Metal Active**, Bridge, black. Only for those serious metal players who only went our highest output active bridge pickup.



SM-1-B

Mini-Humbucker **Vintage**, Bridge, chrome. A pickup with gritty Firebird tone, and enough bite to cut through any mix.



SM-1-N

Mini-Humbucker **Vintage**, Neck, chrome. A pickup with gritty Firebird tone, and enough bite to cut through any mix.



SM-2-B

Mini-Humbucker **Custom**, Bridge, chrome. Special blend of bright, single coil high end, and more focused humbucker low end.



SM-2-N

Mini-Humbucker **Custom**, Neck, chrome. Delivers that classic Firebird tone that is a special blend of bright, single coil high end, and more focused humbucker low end.



SM-3-B

Mini-Humbucker **Seymourized**, Bridge, chrome. Alnico 5 magnets deliver a classic tone with beefed up output for a big rocking Firebird bridge tone.



SM-3-N

Mini-Humbucker **Seymourized**, Neck, chrome. Alnico 5 magnets deliver a classic tone with beefed up output for a big rocking Firebird bridge tone.

Tremuckers



TB-BW-B-BLK

Tremucker **Black Winter**, Bridge, black. High-powered ceramic Trem. designed for Black Metal, Death Metal, or any other extreme style.



TB-4-BLK

Tremucker **JB Model**, Bridge, black. Delivers an unmistakable upper midrange attack, a tight, articulate low end, & harmonically rich highs.



TB-4-ZBR

Tremucker **JB Model**, Bridge, zebra. Delivers an unmistakable upper midrange attack, a tight, articulate low end, & harmonically rich highs.



TB-4-WHT

Tremucker **JB Model**, Bridge, white. Delivers an unmistakable upper midrange attack, a tight, articulate low end, & harmonically rich highs.



TB-4-NKL

Tremucker **JB Model**, Bridge, nickel cover. Delivers an unmistakable upper midrange attack, a tight, articulate low end, & harmonically rich highs.

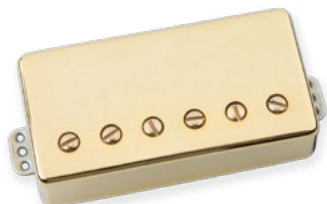

TB-4-GLD

Tremucker **JB Model**, Bridge, gold cover. Delivers an unmistakable upper midrange attack, a tight, articulate low end, & harmonically rich highs.



TB-5-BLK

Tremucker **Custom**, Bridge, black. Perfectly voiced for supreme blues, rock, and metal clarity. Great harmonic content when playing with gain.



TB-5-ZBR

Tremucker **Custom**, Bridge, zebra. Perfectly voiced for supreme blues, rock, and metal clarity. Great harmonic content when playing with gain.



TB-5-NKL

Trembucker **Custom**, Bridge, nickel cover. Perfectly voiced for supreme blues, rock, and metal clarity. Great harmonic content.

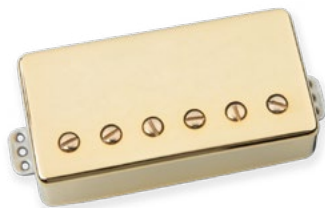

TB-5-GLD

Trembucker **Custom**, Bridge, gold cover. Perfectly voiced for supreme blues, rock, and metal clarity. Great harmonic content.



TB-6-BLK

Trembucker **Distortion**, Bridge, black. Delivers well-balanced rock and metal tones that have rich upper midrange harmonic content.



TB-10-BLK

Trembucker **Full Shred**, Bridge, black. A bright, moderate output rocker with a tight low end, and scooped mids.



TB-10-ZBR

Trembucker **Full Shred**, Bridge, zebra. A bright, moderate output rocker with a tight low end, and scooped mids.



TB-10-WHT

Trembucker **Full Shred**, Bridge, white. A bright, moderate output rocker with a tight low end, and scooped mids.



TB-11-BLK

Trembucker **Custom Custom**, black. Medium hot output combined with the warmth of an alnico 2 bar magnet, it delivers a full, fat sound with singing highs and buttery lows.



TB-11-WHT

Trembucker **Custom Custom**, white. Medium hot output combined with the warmth of an alnico 2 bar magnet, it delivers a full, fat sound with singing highs and buttery lows.



TB-12-BLK

Trembucker **Screamin Demon**, black. A medium output F-spaced humbucker designed to deliver crisp 80s sizzle with a scooped midrange.



TB-14-BLK

Trembucker **Custom 5**, Bridge, black. Nice, full tone, a scooped midrange, and strikes a nice balance of bass & treble. This even response makes it great for all types of music



TB-14-WHT

Trembucker **Custom 5**, Bridge, white. Nice, full tone, a scooped midrange, and strikes a nice balance of bass & treble. This even response makes it great for all types of music



TB-15-WHT

Trembucker **Alternative 8**, Bridge, white. Uses custom high output coils, along with a powerful alnico 8. Sweet treble response of alnico 2, with the midrange emphasis of alnico 5.



TB-59-BLK

Trembucker **The 59' Model**, Bridge, black. A versatile P.A.F. humbucker with an articulate treble attack, full bottom end, and scooped midrange.



TB-59-NKL

Trembucker **The 59' Model**, Bridge, nickel cover. A versatile P.A.F. hum. with an articulate treble attack, full bottom end, & scooped midrange.

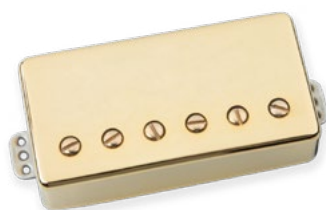

TB-59-GLD

Trembucker **The 59' Model**, Bridge, gold cover. A versatile P.A.F. humbucker with an articulate treble attack, full bottom end, & scooped midrange.



TBAPH-1-B-BLK

Trembucker **Alnico II Pro**, Bridge, black. Spaced warm and sweet vintage output bridge pickup for Blues and Rock.

Parallel Axis
Tremuckers



TB-PG1B-BLK

Tremucker **Pearly Gates**, Bridge, black. An F-spaced version of our special P.A.F. with extra midrange sizzle and tons of Texas attitude.



PA-TB1-B-BLK

Tremucker **Parallel Axis Original**, Bridge, black. Delivers increased sustain + lots of upper mids for this hot, bright pickup. Great for all things rock.



PA-TB1-N-BLK

Tremucker **Parallel Axis Original**, Neck, black. Delivers increased sustain + lots of upper mids for this hot, bright pickup. Great for all things rock.



PA-TB2-B-BLK

Tremucker **Parallel Axis Distortion**, Bridge, black. Provides a searing, saturated bridge tone thats great for all styles of heavy rock and metal.

Stratocaster - Single
Coil-Sized Humbuckers



AXE-SET-W

Single Coil size Humbucker Strat. **Everything Axe**, Set, white. Ultra versatile, consisting of a JB Jr. bridge, Duckbucker middle, and Little 59 neck.



SHR-1-B-BLK

Single Coil size Humbucker Strat. **Hot Rails**, Bridge, black. Our most powerful passive pickup for Strat with all the feel & tone of a high-output hum.



SHR-1-B-PRC

Single Coil size Humbucker Strat. **Hot Rails**, Bridge, parchment. Our most powerful passive pickup with all the feel & tone of a high-output hum.



SHR-1-B-CRM

Single Coil size Humbucker Strat. **Hot Rails**, Bridge, cream. Our most powerful passive pickup with all the feel & tone of a high-output hum.



SHR-1-B-WHT

Single Coil size Humbucker Strat. **Hot Rails**, Bridge, white. Our most powerful passive pickup with all the feel & tone of a high-output hum.



SHR-1-N-BLK

Single Coil size Humbucker Strat. **Hot Rails**, Neck, black. Our most powerful passive pickup for Strat with all the feel & tone of a high-output hum.



SHR-1-N-PRC

Single Coil size Humbucker Strat. **Hot Rails**, Neck, parchment. Our most powerful passive pickup with all the feel & tone of a high-output hum.



SHR-1-N-CRM

Single Coil size Humbucker Strat. **Hot Rails**, Neck, cream. Our most powerful passive pickup with all the feel & tone of a high-output hum.



SHR-1-N-WHT

Single Coil size Humbucker Strat. **Hot Rails**, Neck, white. Our most powerful passive pickup with all the feel & tone of a high-output hum.



SVR-1-B-BLK

Single Coil size Humbucker Strat. **Vintage Rails**, Bridge, black. Gives you even sustain while bending notes, and delivers single coil like sparkle with vintage output.



SVR-1-B-WHT

Single Coil size Humbucker Strat. **Vintage Rails**, Bridge, white. Gives you even sustain while bending notes, and delivers single coil like sparkle with vintage output.



SVR-1-N-BLK

Single Coil size Humbucker Strat. **Vintage Rails**, Neck, black. Gives you even sustain while bending notes, and delivers single coil like sparkle with vintage output.



SVR-1-N-WHT

Single Coil size Humbucker Strat. **Vintage Rails**, Bridge, white. Gives you even sustain while bending notes, and delivers single coil like sparkle with vintage output.



SCR-1-B-BLK

Single Coil size Humbucker Strat. **Cool Rails**, Bridge, black. Nicely balanced, smooth and bluesy humbucker tone in a single coil rails size.



SCR-1-B-WHT

Single Coil size Humbucker Strat. **Cool Rails**, Bridge, white. Nicely balanced, smooth and bluesy humbucker tone in a single coil rails size.



SL59-1-B-BLK

Single Coil size Hum. Strat. **Little '59**, Bridge, black. With the growl and warmth of a P.A.F., it will transform your Strat. into a 59' Les Paul.



SL59-1-B-WHT

Single Coil size Hum. Strat. **Little '59**, Bridge, white. With the growl and warmth of a P.A.F., it will transform your Strat. into a 59' Les Paul.



SL59-1-N-BLK

Single Coil size Hum. Strat. **Little '59**, Neck, black. With the growl and warmth of a P.A.F., it will transform your Strat. into a 59' Les Paul.



SL59-1-N-WHT

Single Coil size Hum. Strat. **Little '59**, Neck, white. With the growl and warmth of a P.A.F., it will transform your Strat. into a 59' Les Paul.



SDBR-1-B-BLK

Single Coil size Humbucker Strat. **Duckbusters**, Bridge, black. Vintage output single coil-size humbucker voiced for total Strat quack.



SDBR-1-B-WHT

Single Coil size Humbucker Strat. **Duckbusters**, Bridge, white. Vintage output single coil-size humbucker voiced for total Strat quack.



SDBR-1-N-BLK

Single Coil size Humbucker Strat. **Duckbusters**, Neck/middle, black. Vintage output single coil-size humbucker voiced for total Strat quack.



SDBR-1-N-WHT

Single Coil size Humbucker Strat. **Duckbusters**, Neck/middle, white. Vintage output single coil-size humbucker voiced for total Strat quack.



SLSD-1-B-BLK

Single Coil size Hum. Strat. **Little Screamin Demon**, Bridge, black. Big and percussive without being harsh, can scream & provide rich harmonics.



SLSD-1-B-WHT

Single Coil size Hum. Strat. **Little Screamin Demon**, Bridge, white. Big & percussive without being harsh, can scream & provide rich harmonics.



SLSD-1-N-BLK

Single Coil size Humbucker Strat. **Little Screamin Demon**, Neck, black. Big and percussive without being harsh, this bridge pickup can scream and provide rich harmonics.



SLSD-1-N-WHT

Single Coil size Humbucker Strat. **Little Screamin Demon**, Neck, white. Big and percussive without being harsh, this bridge pickup can scream and provide rich harmonics.



SBBJ-1-B-BLK

Single Coil size Humbucker Strat. **Jeff Beck Junior**, Bridge, black. Delivers all the upper midrange harmonics and power to breathe new life.



SBBJ-1-B-PAR

Single Coil size Humbucker Strat. **Jeff Beck Junior**, Bridge, parchment. Delivers all the upper midrange harmonics & power to breathe new life.



SBBJ-1-B-WHT

Single Coil size Humbucker Strat. **Jeff Beck Junior**, Bridge, white. Delivers all the upper midrange harmonics and power to breathe new life.



SBBJ-1-N-BLK

Single Coil size Humbucker Strat. **Jeff Beck Junior**, Neck, black. Delivers all the upper midrange harmonics and power to breathe new life.



SBBJ-1-N-WHT

Single Coil size Humbucker Strat. **Jeff Beck Junior**, Neck, white. Delivers all the upper midrange harmonics and power to breathe new life.

Telecaster - Single Coil-Sized Humbuckers



STK-T1-N

Single Coil size Hum. Tele. **Vintage Stack**, Neck, nickel cover. Deliver that classic, warm, punchy neck tone without the traditional single coil hum



STK-T2-B-BLK

Single Coil size Hum. Tele. **Hot Stack**, Neck, black. A full sounding noiseless pickup that uses an alnico 5 bar magnet to deliver even string balance and medium output.



STK-T3-B-BLK

Single Coil size Hum. Tele. **Vintage Stack**, Bridge, black. Our unique noiseless Stack design keeps all the classic Tele. twang & bite without the hum.



STHR-1B-BLK

Single Coil size Hum. Tele. **Hot Rails Lead**, Bridge, black. Unapologetic, mean sound with the power of a full-sized high-output humbucker.



STHR-1N-BLK

Single Coil size Hum. Tele. **Hot Rails Rhythm**, Neck, black. Impossibly huge sounding, can match any high output bridge.



STHR-1-SET

Single Coil size Hum. Tele. **Hot Rails**, Set, black. Tele sized dual blade humbucker set that will transform your Telecaster into a high output rocker.



ST59-1B-BLK

Single Coil size Hum. Tele. **Little '59**, Bridge, black. Full sounding, medium output hum. tone that drops into the bridge position of your Telecaster.



SJAG-1-B

Single Coil **Jaguar Vintage**, Bridge. Clear, bright, and authentic, this vintage correct single-coil Jaguar pickup delivers that classic 60s tone.

SINGLE COILS Single Coil Jaguar pickups



SJAG-1-N

Single Coil **Jaguar Vintage**, Neck. Clear, bright, and authentic, this vintage correct single-coil Jaguar pickup delivers that classic 60s tone.



SJAG-2-B

Single Coil **Hot Jaguar**, Bridge. Big sounding, and full of midrange, this overwound single-coil Jaguar pickup delivers a fat, hot rodded bridge tone.



SJAG-2-N

Single Coil **Hot Jaguar**, Neck. Big sounding, and full of midrange, this overwound single-coil Jaguar pickup delivers a fat, hot rodded bridge tone.



SJAG-3-N

Single Coil **Quarter Pound Jaguar**, Neck. High output Alnico 5 diameter. Just the right amount of high end to balance with its powerful bottom end.

Stratocaster
Single Coils Vintage



SSL-1

Single Coil **Vintage Staggered Strat**, Bridge. Produce that bright, glassy, bell tone with all of the bounce and sparkle youd expect from the best 50s Strat pickups.



SSL-1-RW/RP

Single Coil **Vintage Staggered Strat reverse**, Middle. Produce that bright, glassy, bell tone with all of the bounce and sparkle youd expect from the best 50s Strat pickups.



SSL-1-SET

Single Coil **Vintage Staggered Strat**, Set. Delivers all the chime and bell tone enjoyed by Stratocaster players in the 50s.



SSL-1-L

Single Coil **Vintage Staggered Strat**, Left, Bridge. Produce that bright, glassy, bell tone with all of the bounce and sparkle youd expect from the best 50s Strat pickups.



SSL-1-RW/RP-L

Single Coil **Vintage Staggered Strat reverse**, Left, Middle. Produce that bright, glassy, bell tone with all of the bounce and sparkle youd expect from the best 50s Strat pickups.



APS-1

Single Coil **Alnico II Pro Staggered Strat**, Bridge. Delivers all of the chime and bell tone enjoyed by Stratocaster players in the 50s, but with a sweeter treble attack.



APS-1-RW/RP

Single Coil **Alnico II Pro Staggered Strat reverse**, Middle. Delivers all of the chime and bell tone enjoyed by Stratocaster players in the 50s, but with a sweeter treble attack.



APS-1-SET

Single Coil **Alnico II Pro Staggered Strat**, Set. Delivers all of the chime and bell tone enjoyed by Stratocaster players in the 50s, but with a sweeter treble attack.



APS-2

Single Coil **Alnico II Pro Flat Strat**, Bridge, white. Delivers a sweet, smooth tone for flatter fingerboards and lighter string gauges.



APS-2-RW/RP

Single Coil **Alnico II Pro Flat Strat reverse**, Middle, white. Delivers a sweet, smooth tone for flatter fingerboards and lighter string gauges.



SSL52-1-B-WHT

Single Coil **Five-Two Strat**, Bridge, white. Staggered, uses a mix of alnico 2 + 5 rod magnets specifically positioned for sweet highs & tight lows.



SSL52-1-WHT

Single Coil **Five-Two Strat**, Neck, white. Staggered, uses a mix of alnico 2 + 5 rod magnets specifically positioned for sweet highs & tight lows.



SSL52-1-RW/RP

Single Coil **Five-Two Strat reverse**, Middle, white. Uses a unique combination of alnico 2 and 5 rod magnets for sweet highs and tight lows.



SSL-2

Single Coil **Vintage Strat Flat**. Delivers a shimmering tone for guitars with flatter fingerboards and lighter string gauges.



SSL-2-RW-RP

Single Coil **Vintage Strat Flat reverse**, Middle. Delivers that classic 2 & 4 quack tone without any noise for modern set-ups.



ZSL-1B

Single Coil **Zephyr**, Bridge, black. The world's first silver wire Hi-Fi Strat pickup set, designed for extended freq. range, complex harmonic content, & amazing dynamic response.

Stratocaster - Single Coils Alternative



ZSL-1M

Single Coil **Zephyr**, Middle, black. The world's first silver wire Hi-Fi Strat pickup set, designed for extended frequency range, complex harmonic content, & amazing dynamic response.



ZSL-1N

Single Coil **Zephyr**, Neck, black. The world's first silver wire Hi-Fi Strat pickup set, designed for extended frequency range, complex harmonic content, & amazing dynamic response.



SSL-3

Single Coil **Hot Strat**, Bridge, white. Huge sounding Stratocaster single coil with tons of output and midrange. Perfect for beefing up your bridge position.



SSL-3-RW/RP

Single Coil **Hot Strat reverse**, Middle, white. For a unique beefed up 'in-between' sound without hum, use the reverse wound/reverse polarity version of our Hot Strat.



SSL-3-SET

Single Coil **Hot Strat Calibrated**, Set, white. A complete set of our high output, mid focused Stratocaster single coils that will make your tone cut through like a humbucker.



SSL-4

Single Coil **Quarter Pound Strat**. The most explosive sounding Seymour Duncan single coil for Strat with a meaner, fatter tone.



SSL-4T

Single Coil **Quarter Pound Strat Tapped**, Set. The most explosive sounding Seymour Duncan single coil for Strat with a meaner, fatter tone.



SSL-4-RW/RP

Single Coil **Quarter Pound Strat reverse**, Middle. Reverse wound-reverse polarity version of our heaviest hitting Strat single coil.



SSL-4-SET

Single Coil **Quarter Pound Strat**, Set. Quarter inch alnico 5 rod magnets for that huge R. Blackmore Strat tone. Big, mean and perfect for heavy rock.



SSL-5

Single Coil **Custom Stag Strat**. The ultimate overwound Strat single coil pickup, found in the bridge position of the David Gilmour Sign. Fender Strat.



SSL-5-RW/RP

Single Coil **Custom Stag Strat reverse**, Middle. The reverse wound-reverse polarity version of our most popular beefed up Strat single coil.



SSL-5-SET

Single Coil **Custom Stag Strat**. The ultimate overwound Strat single coil pickup, deliver bigger, fatter chords, and will cut through the mix more clearly than any traditional single coil.



SSL-6

Single Coil **Custom Flat Strat**. Classic Strat. pickup with a flat magnet pattern for beefing up guitars with lighter string gauges & flatter fretboards.



SSL-7

Single Coil **Quarter Pound Stagge-red Strat**. Quarter inch rod magnets give extra output & punch + the staggered delivers an edgier tone.



SSL-7T

Single Coil **Quarter Pound Stagge-red Strat Tapped**. Quarter inch rod magnets give extra output & punch + the staggered delivers an edgier tone.



SSL-7-RWRP

Single Coil **Quarter Pound Stagge-red Strat reverse**, Middle. A staggered pole pattern delivers an edgier tone & the quarter inch rod magnets give extra output and punch.



AS-1B

Single Coil **Blackouts Strat**, Bridge. High output active bridge pickup for Strat that provides hot humbucker tone in a drop-in single coil size.



AS-1N

Single Coil **Blackouts Strat**, Neck-middle. High output active Strat neck/middle pickup that provides hot humbucker tone in a single coil size.



SLS-1-B-CHR

Lipstick Tube Strat, Bridge, chrome. Same materials, construction & tone as our Danelectro replacement but modified as a standard-sized Strat pickup.



SLS-1-CHR

Lipstick Tube Strat, Neck, chrome. Same materials, construction & tone as our Danelectro replacement but modified as a standard-sized Strat pickup.

**Stratocaster
Hum-Canceling Stack**



SLS-1-RW/RP-CHR

Lipstick Tube Strat reverse, Middle, chrome. Our Danelectro replac. but modified as a standard-sized Strat pickup with reverse wind/reverse polarity



STK-S2-B-BLK

Single Coil **Hot Stack Strat**, Bridge, black. Powerful Strat sound with smooth string to string balance and no hum.



STK-S2-B-WHT

Single Coil **Hot Stack Strat**, Bridge, white. Powerful Strat sound with smooth string to string balance and no hum.



STK-S2-N-BLK

Single Coil **Hot Stack Strat**, Neck, black. Powerful Strat sound with smooth string to string balance and no hum.



STK-S2-N-WHT

Single Coil **Hot Stack Strat**, Neck, white. Powerful Strat sound with smooth string to string balance and no hum.



STK-S4-B-BLK

Single Coil **Stack Plus Strat**, Bridge, black. Hand tuned for that warm bell like tone without any of the associated 60-cycle hum.



STK-S4-B-WHT

Single Coil **Stack Plus Strat**, Bridge, white. Hand tuned for that warm bell like tone without any of the associated 60-cycle hum.



STK-S4-M-BLK

Single Coil **Stack Plus Strat**, Middle, black. Hand tuned for that warm bell like tone without any of the associated 60-cycle hum.



STK-S4-M-WHT

Single Coil **Stack Plus Strat**, Middle, white. Hand tuned for that warm bell like tone without any of the associated 60-cycle hum.



STK-S4-N-BLK

Single Coil **Stack Plus Strat**, Neck, black. Hand tuned for that warm bell like tone without any of the associated 60-cycle hum.



STK-S4-N-WHT

Single Coil **Stack Plus Strat**, Neck, white. Hand tuned for that warm bell like tone without any of the associated 60-cycle hum.



STK-S6-B-BLK

Single Coil **Custom Stack Plus Strat**, Bridge, black. Delivers the punch, chime, and sustain of a hot Stratocaster single coil without any of the hum



STK-S6-B-WHT

Single Coil **Custom Stack Plus Strat**, Bridge, white. Delivers the punch, chime, and sustain of a hot Stratocaster single coil without any of the hum



STK-S7-BLK

Single Coil **Vintage Hot Stack Plus Strat**, black. Delivers authentic Strat. tone with a touch more warmth, sustain, and sweetness.



STK-S7-WHT

Single Coil **Vintage Hot Stack Plus Strat**, white. Delivers authentic Strat. tone with a touch more warmth, sustain, and sweetness.



STK-S7-C

Single Coil **Vintage Hot Stack Plus Strat**, cream. Delivers authentic Strat. tone with a touch more warmth, sustain, and sweetness.

Telecaster
Single Coils Vintage



STK-S9-B-BLK

Single Coil **Hot Stack Plus Strat**, Bridge, black. Our highest output noiseless, individually tuned. Its great for rich & powerful midrange harmonics.



STK-S9-B-WHT

Single Coil **Hot Stack Plus Strat**, Bridge, white. Our highest output noiseless, individually tuned. Its great for rich & powerful midrange harmonics.



STR-1

Single Coil **Vintage Tele**, Neck, chrome. Our Vintage Telecaster Rhythm pickup brings out the warm, open tone of the best 54 Teles.



STR-1-RW/RP

Single Coil **Vintage Tele reverse**, Neck, chrome. Our Vintage Telecaster Rhythm pickup brings out the warm, open tone of the best 54 Teles.



STL-1

Single Coil **Vintage '54 Tele**, Bridge, black. A vintage correct 54 Telecaster Lead pickup. This is the Tele lead tone, full of twang, bite, and bark.



STL-1B

Single Coil **Vintage Broadcaster Tele**, Bridge, black. Delivers that classic 50 Telecaster lead tone with extra punch and twang.



STL-1-SET

Single Coil **Vintage Broadcaster Tele**, Set. Our Vintage Broadcaster set delivers that classic 50s Telecaster tone with extra punch and twang.



ZTL-1-B

Single Coil **Zephyr Tele**, Bridge, black. The world's first silver wire Hi-Fi Tele. pickup, with bursting harmonics & unmatched frequency response.

Telecaster - Single
Coils Alternative



ZTR-1-N

Single Coil **Zephyr Tele**, Neck, black. The world's first silver wire Hi-Fi Tele neck pickup, with clear highs and unprecedented dynamic control.



STL-2

Single Coil **Hot Tele**, Bridge, black. A classic overwound Telecaster lead pickup that is full of twang and bark along with the midrange punch of a humbucker.



STL-2T-BLK

Single Coil **Hot Tele Tapped**, Bridge, black. A classic overwound Telecaster lead pickup that is full of twang and bark along with the midrange punch of a humbucker.



STR-2

Single Coil **Hot Tele**, Neck, chrome. An overwound true single coil that delivers a bigger, fatter neck tone. Thick and sweet with a great low end power.



STL-3

Single Coil **Quarter Pound Tele**, Bridge, black. Seymour Duncan's highest output Tele single coil. Blends Gibson-like harmonics with a quarter pound punch.



STL-3T

Single Coil **Quarter Pound Tele Tapped**, Bridge, black. Seymour Duncan's highest output Tele single coil. Blends Gibson-like harmonics with a quarter pound punch.



STR-3

Single Coil **Quarter Pound Tele**, Neck, chrome. Seymour Duncan's highest output Tele single coil. Overwound for big full chords with a defined high end.



STL52-1

Single Coil **Five-Two Tele**, Bridge, black. Tele lead pickup with a special combination of alnico 2 + 5 magnets, deliver tighter lows & sweeter highs.

P90

P90



STR52-1

Single Coil **Five-Two Tele**, Neck, chrome. Specifically designed to deliver punchy lows and smooth, sweet highs for the Tele rhythm position.



SP90-1-B-BLK

Vintage P90, Bridge, black. Vintage recreation of the 1946 Gibson single-coil with all of the midrange grittiness that makes a P90 pickup so special.



SP90-1-B-CRM

Vintage P90, Bridge, cream. Vintage recreation of the 1946 Gibson single-coil with all of the midrange grittiness that makes a P90 pickup so special.



SP90-1-N-BLK

Vintage P90, Neck, black. Vintage recreation of the 1946 Gibson single-coil with all of the midrange grittiness that makes a P90 pickup so special.



SP90-1-N-CRM

Vintage P90, Neck, cream. Vintage recreation of the 1946 Gibson single-coil with all of the midrange grittiness that makes a P90 pickup so special.



SP90-2-B-BLK

Hot P90, Bridge, black. Hot P90 bridge designed with dual ceramic bar magnets and wound for extra power and midrange.



SP90-2-B-CRM

Hot P90, Bridge, cream. Hot P90 bridge designed with dual ceramic bar magnets and wound for extra power and midrange.



SP90-2-N-BLK

Hot P90, Neck, black. Hot P90 bridge designed with dual ceramic bar magnets and wound for extra power and midrange.



SP90-2-N-CRM

Hot P90, Neck, cream. Hot P90 bridge designed with dual ceramic bar magnets and wound for extra power and midrange.



SP90-3-B-BLK

Custom P90, Bridge, black. Seymour Duncan's most powerful P90 soapbar delivers a tight low end punch, and a mean midrange growl.



SP90-3-N-BLK

Custom P90, Neck, black. Seymour Duncan's most powerful P90 soapbar delivers a tight low end punch, and a mean midrange growl.



STK-P1-B-BLK

P90 Stack, Bridge, black. Delivers a noiseless, vintage style, P90 soapbar tone for any guitar with a P90 sized pickup route.



STK-P1-B-CRM

P90 Stack, Bridge, cream. Delivers a noiseless, vintage style, P90 soapbar tone for any guitar with a P90 sized pickup route.



STK-P1-N-BLK

P90 Stack, Neck, black. Delivers a noiseless, vintage style, P90 soapbar tone for any guitar with a P90 sized pickup route.



STK-P1-N-CRM

P90 Stack, Neck, cream. Delivers a noiseless, vintage style, P90 soapbar tone for any guitar with a P90 sized pickup route.



SPH90-1B-NKL

P90 Phat Cat, Bridge, nickel cover. A true P90 bridge tone in a standard sized humbucker slot. Give you chords with lots of bright harmonics



SPH90-1B-GLD

P90 Phat Cat, Bridge, gold cover. A true P90 bridge tone in a standard sized humbucker slot. Give you chords with lots of bright harmonics



SPH90-1N-NKL

P90 Phat Cat, Neck, nickel cover. A true P90 bridge tone in a standard sized humbucker slot. Give you chords with lots of bright harmonics



SPH90-1N-GLD

P90 Phat Cat, Neck, gold cover. A true P90 bridge tone in a standard sized humbucker slot. Give you chords with lots of bright harmonics



BEN-A6-BLK

Humbucker **Benedetto A6**, Neck, black cover. Warm, full sounding Jazz humbucker with lots of top end clarity. Great for any Jazz box.



BEN-A6-GLD

Humbucker **Benedetto A6**, Neck, gold cover. Warm, full sounding Jazz humbucker with lots of top end clarity. Great for any Jazz box.



BEN-PAF-BLK

Humbucker **Benedetto P.A.F.**, Nickel, black cover. Produces a full-bodied tone reminiscent of the original hum. designed by Seth Lover in the 50s.



BEN-PAF-GLD

Humbucker **Benedetto P.A.F.**, Neck, gold cover. Produces a full-bodied tone reminiscent of the original hum. designed by Seth Lover in the 50s.



BEN-B6

Humbucker **Benedetto B6**, Jazz Guitar, black. This pickup is naturally-voiced, mirroring the balance, warmth & richness of a fine archtop to help bring out its true acoustic essence.

HUMBUCKERS

Antiquity Pickups



BEN-B7

Humbucker **Benedetto B7**, Jazz Guitar, black. 7-string version of the B-6 model. Mounts into any standard 7-string sized humbucker slot using a 7-string humbucker mounting ring.



BEN-S6

Humbucker **Benedetto S6**, Jazz Guitar, black. Low profile, naturally voiced, humbucking pickup for acoustic archtop guitars with steel or bronze strings.



BEN-S7

Humbucker **Benedetto S7**, Jazz Guitar, black. 7-string version of the Benedetto pickguard (floating), low profile, naturally voiced, humbucking pickup for acoustic archtop guitars.



ANT-HB

Humbucker **Antiquity**, Bridge, nickel cover. Made to look & sound like a 50s humb. this pickup has a smooth, warm neck tone with a sweetness that only an Antiquity can deliver.



ANT-HB-GLD

Humbucker **Antiquity**, Bridge, gold cover. Made to look & sound like a 50s humb. this pickup has a smooth, warm neck tone with a sweetness that only an Antiquity can deliver.



ANT-HN

Humbucker **Antiquity**, Neck, nickel cover. Made to look & sound like a 50s humb. this pickup has a smooth, warm neck tone with a sweetness that only an Antiquity can deliver.



ANT-HN-GLD

Humbucker **Antiquity**, Neck, gold cover. Made to look & sound like a 50s humb. this pickup has a smooth, warm neck tone with a sweetness that only an Antiquity can deliver.



ANT-JB

Humbucker **Antiquity JB**, Bridge, zebra. Vintage version of the JB, gives you all of the classic midrange with a slightly sweetened treble response.

MINI-HUMBUCKERS

SINGLE COILS



ANT-JM

Humbucker **Antiquity Jazz**, Neck, zebra. The Antiquity Jazz Model Neck is an aged version of our brightest, most articulate neck pickup



ANTII-AMHB

Mini-Humbucker **Antiquity II**, Bridge, (adjust. pole pces). Classic Les Paul Deluxe bridge tone with rich midrange harmonics & an authentic 60s growl.



ANTII-AMHN

Mini-Humbucker **Antiquity II**, Neck, (adjust. pole pces). Classic Les Paul Deluxe bridge tone with rich midrange harmonics & an authentic 60s growl.



ANT-SCB

Single Coil **Antiquity Texas Hot Strat**, Bridge. Vintage Stratocaster sparkle with added output and warmth for the bridge position.



ANT-STH

Single Coil **Antiquity Texas Hot Strat**, Neck. Give you the authentic chime, sparkle, and feel that only a vintage single coil pickup deliver.



ANT-STH-RW/RP

Single Coil **Antiquity Texas Hot Strat reverse**, Middle. Give you the authentic chime, sparkle, & feel that only a vintage single coil pickup deliver.



ANTII-SS

Single Coil **Antiquity II Surfer Strat**, Neck. Delivers bright, glassy Strat tone, with a slightly softened treble attack.



ANTII-SS-RW/RP

Single Coil **Antiquity II Surfer Strat reverse**, Neck. Designed to work with an Antiquity II Surf to deliver that sparkly Strat quack, in pos. 2 & 4.



ANTII-SS-SET

Single Coil **Antiquity II Surfer Strat**, Set. Bright, punchy, and aged to perfection, captures all the classic single coil tones from the 60's.



ANT-TB

Single Coil **Antiquity Tele**, Bridge. Classic twangy 50s Tele Lead tone, custom aged for a smoother treble response.



ANT-TN

Single Coil **Antiquity Tele**, Neck. Classic early 50s Tele rhythm tone, with well-rounded low end and a nice sweet treble response.



ANTII-TTB

Single Coil **Antiquity II Tele**, Bridge. Tribute to the 1960s gray bottom Tele lead pickup. Bright & twangy with a slight softening of the treble response.



ANTII-TTN

Single Coil **Antiquity II Tele**, Neck. The perfect match for the unique picking style and intricate bends used on mid-60s maple neck Tele.



ANTII-MMB

Single Coil **Antiquity II Mustang**, Bridge. Honky and springy 60s Mustang bridge tone, with flat magnets and the mellowing qualities of our custom aging process.



ANTII-MMN

Single Coil **Antiquity II Mustang**, Neck. Honky and springy 60s Mustang bridge tone, with flat magnets and the mellowing qualities of our custom aging process.



ANT-AJB

Single Coil **Antiquity Jaguar**, Bridge. Uses calibrated Alnico 2 rod magnets + a custom coil wind to give you a crisp Surf tone that is smooth & lush.

P90



ANT-AJN

Single Coil **Antiquity Jaguar**, Neck. Uses calibrated Alnico 2 rod magnets + a custom coil wind to give you a crisp Surf tone that is smooth & lush.



ANT-P90-B-BLK

Antiquity P90 Soapbar, Bridge, black. Capture the cool, gritty sparkle from the bridge position of an old 52 Goldtop.



ANT-P90-B-CRM

Antiquity P90 Soapbar, Bridge, cream. Capture the cool, gritty sparkle from the bridge position of an old 52 Goldtop.



ANT-P90-N-BLK

Antiquity P90 Soapbar, Neck, black. Capture the sweet, weathered neck position single coil tone of an old 52 Goldtop.



ANT-P90-N-CRM

Antiquity P90 Soapbar, Neck, cream. Capture the sweet, weathered neck position single coil tone of an old 52 Goldtop.



ANT-P90DE-B-BLK

Antiquity P90 «Dog Ear», Bridge, black. Capture the weathered midrange grittiness from the bridge position of an original 59 ES-330.



ANT-P90DE-N-BLK

Antiquity P90 «Dog Ear», Neck, black. Capture the weathered midrange grittiness from the neck position of an original 59 ES-330.



ANT-JMB

Antiquity II Jazzmaster, Bridge, cream. Uses calibrated alnico 5 rod magnets with a period correct coil wind.

PU

Jazzmaster Pickups



ANT-JMN

Antiquity II Jazzmaster, Neck, cream. Uses calibrated alnico 2 rod magnets and a custom coil wind to give you that classic Ventures tone.



SJM-1-B-BLK

Single Coil **Vintage Jazzmaster**, Bridge, black. Clear, with boosted highs & mids, our vintage-correct single-pickup delivers that classic late 50s coil Jazzmaster tone.



SJM-1-N-BLK

Single Coil **Vintage Jazzmaster**, Neck, black. Clear, with boosted highs & mids, our vintage-correct single-pickup delivers that classic late 50s coil Jazzmaster tone.



SJM-2-B

Single Coil **Hot Jazzmaster**, Bridge, black. Overwound single-coil delivers a hot rodded Jazzmaster tone with lots of growl.

Lipstick Tube Danelectro



SJM-2-N

Single Coil **Hot Jazzmaster**, Neck, black. Overwound single-coil delivers a hot rodded Jazzmaster tone with lots of growl.



SJM-3-B

Single Coil **Quarter Pound Jazzmaster**, Bridge, black. Powerful lead tone with a custom overwound coil and large diameter rod magnets.



SJM-3-N

Single Coil **Quarter Pound Jazzmaster**, Neck, black. Powerful lead tone with a custom overwound coil and large diameter rod magnets.



SLD-1B

Single Coil **Lipstick Tube Danelectro**, Bridge, nickel. Our drop-in replacement pickup for Danelectro guitars delivers that classic Dano chime.

Artist Signature pickup



SLD-1N

Single Coil **Lipstick Tube Danelectro**, Neck, nickel. Our drop-in replacement pickup for Danelectro guitars delivers that classic Dano chime.



SH-13-BLK

Humbucker **Dimebucker**, Bridge, black. Massive metal tone dialed to the exact specs of Dimebag Darrell. Beef, crunch, edge, balls.



SH-13-S-BLK

Humbucker **Dimebag**, Set, black. Dimebag wanted it all smooth and crunchy distortion tone, biting treble, punchy bass, but smooth.



APH-2B-BLK

Humbucker **Slash Alnico II Pro**, Bridge, black. Voiced with Slash to give every guitar that classic Appetite for Destruction tone.



APH-2B-ZBR

Humbucker **Slash Alnico II Pro**, Bridge, zebra. Voiced with Slash to give every guitar that classic Appetite for Destruction tone.



APH-2B-ZEB-REV

Humbucker **Slash Alnico II Pro reverse**, Bridge, zebra. Voiced with Slash to give every guitar that classic Appetite for Destruction tone.



APH-2N-BLK

Humbucker **Slash Alnico II Pro**, Neck, black. Voiced with Slash to give every guitar that classic Appetite for Destruction tone.



APH-2N-ZBR

Humbucker **Slash Alnico II Pro**, Neck, zebra. Voiced with Slash to give every guitar that classic Appetite for Destruction tone.



APH-2N-ZEB-REV

Humbucker **Slash Alnico II Pro reverse**, Neck, zebra. Voiced with Slash to give every guitar that classic Appetite for Destruction tone.



APH-2S-BLK

Humbucker **Slash Alnico II Pro**, Set, black. The classic tone of Appetite for Destruction in a pickup.



APH-2S-ZBR

Humbucker **Slash Alnico II Pro**, Set, zebra. The classic tone of Appetite for Destruction in a pickup.



APH-2S-ZRZ-4C

Humbucker **Slash Alnico II Pro 4 conductors**, Set, zebra. The classic tone of Appetite for Destruction in a pickup.



PBH-B-Z

Humbucker **Jason Becker «Perpetual Burn»**, Bridge, zebra. A testament to the power of shred, this bridge lends any guitar a harmonic intensity worthy of Jason Becker.



AHB-3B-BLK

Active Humbucker **Mick Thomson Blackout**, Bridge. Increased high-end & tightened bass response make this active pickup the linchpin in M. Thomson's sign. detuned carnage.



AHB-3N-BLK

Active Humbucker **Mick Thomson Blackout**, Neck. Increased high-end & tightened bass response make this active pickup the linchpin in M. Thomson's sign. detuned carnage.



AHB-3S-BLK

Active Humbucker **Mick Thomson Blackout**, Set. Make the maggots squirm with Slipknot guitarist Mick Thomson's sign. active humbucker.



AHB-3B-7-PHASE2

Active Humbucker **Mick Thomson Blackout**, 7-String Bridge. The increased high-end & tightened bass response, for extended range instr.



SH-DAVE-MUSTAINE-SET

Active Humbucker **Dave Mustaine LW-Must**, Set, nickel. Deliver the distinct tonal character of the JB Jazz combo but with extra ferocity & gain



MH-ALPHA-N-N

Humbucker **Mark Holcomb Alpha**, Neck, black. Voiced to combine the best qualities, with some of that fat glassy sound but also plenty of your pick attack & fretting-hand phrasing.



MH-OMEGA-B-N

Humbucker **Mark Holcomb Alpha**, Bridge, black. Provide destructive percussive and growl in the mids and low end. It's aggressive but it also has lots of clarity and brightness.



MH-ALPHA-OMEGA-SET-7

Humbucker **Mark Holcomb Alpha & Omega**, 7-String, Set, black. Created to provide destructive perc. & growl in the mids and low end.



RED-DEVIL-N-W

Single Coil **Billy Gibbons Red Devil**, Neck, white. Will fit in any Strat-sized single coil rout—proving tone as big as Texas can come in deceptively small packages.



RED-DEVIL-M-W

Single Coil **Billy Gibbons Red Devil**, Middle, white. Will fit in any Strat-sized single coil rout—proving tone as big as Texas can come in deceptively small packages.



RED-DEVIL-B-W

Single Coil **Billy Gibbons Red Devil**, Bridge, white. Will fit in any Strat-sized single coil rout—proving tone as big as Texas can come in deceptively small packages.



BG-1400

Single Coil **Billy Gibbons BG1400**, Bridge, black. If you and your Tele® are ready for something that's a little fatter & hum-canceling without sacrificing too much of the twang factor



TB-8-SG

Trembucker **Synyster Gates Invader**, Bridge, black. For metal, punk and rock players who seek max power and sustain.



TB-PBH-Z

Trembucker **Jason Becker «Perpetual Burn»**, Bridge, zebra. Lends any tremolo equipped guitar a harmonic intensity worthy of Jason Becker.



PA-TB3-B-BLK

Trembucker **Parallel Axis Blue Saraceno**, Bridge, black. Delivers a truly versatile tone, specifically voiced by Blues Saraceno.



APTL-3JD-BLK

Single Coil **Jerry Donahue Tele**, Bridge, black. Vintage-hot lead pickup that balances a sweet, musical treble attack with traditional Tele twang.



STK-S10-B-BLK

Single Coil **YJM Fury Strat**, Bridge, black. Noiseless single coil voiced by Yngwie J Malmsteen, specifically wound hotter for better balance.



STK-S10-B-WHT

Single Coil **YJM Fury Strat**, Bridge, white. Noiseless single coil voiced by Yngwie J Malmsteen, specifically wound hotter for better balance.



STK-S10-N-BLK

Single Coil **YJM Fury Strat**, Neck, black. Noiseless single coil voiced by Y. J Malmsteen, delivers an articulate & fluid response to rapid pick attack.

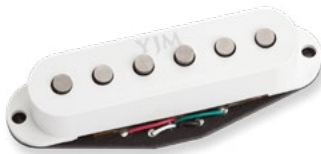

STK-S10-N-WHT

Single Coil **YJM Fury Strat**, Neck, white. Noiseless single coil voiced by Y. J Malmsteen, delivers an articulate & fluid response to rapid pick attack.



STK-S10-S-BLK

Single Coil **YJM Fury Strat**, Set, black. Voiced by Yngwie himself, this set of noiseless Strat single coils will give you the articulate and fluid response you need to bring The Fury.



STK-S10-S-WHT

Single Coil **YJM Fury Strat**, Set, white. Voiced by Yngwie himself, this set of noiseless Strat single coils will give you the articulate and fluid response you need to bring The Fury.



JH-1S-W

Single Coil **Jimi Hendrix Sign. Strat**, Set, white. Have roots in the trad. but with an eye on the future. Each pickup is custom wound for a richer, melodic tone.



Humbuckers



PVZHB

Humbucker **Truebucker**, black. A great and authentic PAF reproduction. Handwound in Texas. Great Sound, great dynamics!

Single Coil



PVRCR

Single Coil **Rock**, Set of 3 pickups. More power - more punch, but vintage orientated.



PVZBR

Single Coil **Blues reverse**, Middle. Slightly raised middle frequencies with warm and softer treble response. Reverse wound / polarity..



PVZBL

Single Coil **Blues**, Set of 3 pickups. Slightly raised middle frequencies with warm and softer treble response. Sound is rounded off harmonically. Reverse: PVZBL-RWRP



PVZPLUS

Single Coil **VintagePlus**, Set of 3. More output - more power, but still vintage style.



PVZTB

Single Coil **True Vintage Tele**, Bridge. This bridge pickup with its full twang and its warm treble reminds of a original Broadcaster sound.



PVZTR

Single Coil **True Vintage Tele reverse**, Middle. The real thing for those who like the sound of the 50s! Reverse wound / polarity.



PVZTV

Single Coil **True Vintage Tele**, Set of 3. The real thing for those who like the sound of the 50s! The middle pickup is NOT reverse



Soundhole

Piezo Saddle



EMG-ACS

Archtop **ACS**, Black. Offering a broader frequency range than a piezo pickup, delivers authentic acoustic tone with enough volume to play alongside a large band.



EMG-AT93U

Piezo Saddle **AT93U**. Available in 3/32". A natural sounding saddle pick-up with end pin jack. Uses piezo film layered in a bimorph design, giving it several unique advantages.



EMG-AT93-L

Piezo Saddle **AT93U-L**. Available in 1/8". A natural sounding saddle pick-up with end pin jack. Uses piezo film layered in a bimorph design, giving it several unique advantages.



EMG-AT93-O

Piezo Saddle **Acoustic Saddle**, (piezo only).



EMG-AT125U

Piezo Saddle **AT125U**. Available in 1/8". A natural sounding saddle pick-up with end pin jack. Uses piezo film layered in a bimorph design, giving it several unique advantages.



EMG-AS93

Acoustic Saddle Pickup System **AS93**, for 3/32" saddle, with APA-2 preamp & End Pin Jack. The most natural sounding saddle transducer system in the world.



EMG-AS93-L

Acoustic Split Saddle Pickup System **AS93-L**, with APA-2 preamp & End Pin Jack. The most natural sounding saddle transducer system in the world.



EMG-AS93U

Acoustic Saddle Pickup System **AS93U**, for 3/32 inch saddle, with APA-2 preamp & Ultrajak. The most natural sounding saddle transducer system in the world.

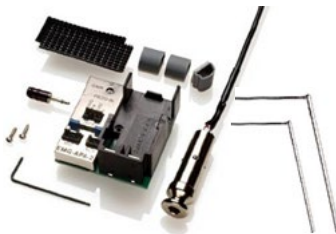

EMG-AS93U-L

Acoustic Saddle Pickup System **AS93U-L**, for 3/32" saddle, with APA-2 preamp & Ultrajak. The most natural sounding saddle transducer system in the world.



EMG-AS125U

Acoustic Saddle Pickup System **AT125U**. Available in 1/8". With APA-2 preamp & Ultrajak. Several unique advantages.



EMG-ACB

Banjo Pickup **ACB**. The choice of pro players due to its authentic recreation of the instrument's natural tone and low noise.



PA1WA

Roger Acoustic Humbucker Pickup. Nicely transparent sounding acoustic pickup with ceramic magnets and adjustable pole screws.



SC-16010100

Preamp Flagship. 5-way-Toggle-Switch. Clear smooth highs, soulful mids & bodacious bass. Dynamic range of 115dB.



SC-16010101

Preamp Flagship. 3-way-Toggle-Switch. Clear smooth highs, soulful mids & bodacious bass. Dynamic range of 115dB.



SC-16050101

Pickup Oyster S/S (single/socket). Give your instrument a natural, warm, full sound instantly, without active switching or preamps.



SC-16050102

Pickup Oyster D/S (double/socket). 2 Piezopickups, with socket for interior mounting. Natural, warm, full sound instantly.



SC-16050103

Pickup Oyster S/P (single/plug). For exterior mounting. Give your instrument a natural, warm, full sound instantly, without active switching or preamps.



Acoustic Pickups
Steel strings



SA-6MAGMIC

Acoustic Pickup **Mag Mic.** Capture natural warmth and full-spectrum detail of your acoustic guitar with a magnetic soundhole pickup and omni-directional mic.



SA-3H

Magnetic Soundhole Pickup **Woody Humcancelling**, maple. Instant mounting hum-canceling soundhole pickup that gives you warm, full sounding acoustic tone.



SA-3SC

Magnetic Soundhole Pickup **Woody Single Coil**, maple. Instant mounting magnetic soundhole pickup delivers crisp, bright tone.



SA-3XL

Magnetic Soundhole Pickup **Woody XL**, maple. Professional soundhole pickup for serious tone and quick installation. With Adjustable Pole Pieces.

Acoustic Pickups
Nylon strings



SA-3XL-WLN

Magnetic Soundhole Pickup **Woody XL**, walnut. Professional soundhole pickup for serious tone and quick installation. With Adjustable Pole Pieces.



DTAR-WAVE-ACOUST

Wavelength Duo, Multi-Source. Capture the full range, detail, body and character of your acoustic guitar. Available in both nylon & steel-string options.



DPU-WAVE-LENGTH-VT

Wavelength Solo, pickup and preamp for acoustic Guitar. A distortion-free under-saddle transducer and a clear-sounding, high-headroom preamp for acoustic guitar.



DPU-WAVE-LENGTH

Vol & Tone Module **Wavelength**. Unleash the power of your Wavelength Solo under-saddle transducer with this Module, part of our Acoustic Pro line.

DIEGO



HBM4A

MM Alnico Pickup, 4-String
The authentic sound of the old "pre Ernie Ball" basses. 4-lead cable!



HBM5A

MM Alnico Pickup, 5-String
The authentic sound of the old "pre Ernie Ball" basses. 4-lead cable!



HBMM1

MM Bass Pickup, 4-string Bartolini-style pickup for Music Man Bases. Ceramic magnets. More velvet sound.



HBMM5

MM Bass Pickup, 5-string Bartolini-style pickup for Music Man Bases. Ceramic magnets. More velvet sound.



DUESENBERG



HB45B

Soapbar Bass Pickup. Neck & Bridge
Velvet bass sound. Bartolini-style for 4- and 5-string basses! 38 x 102mm



PDBNB

BassBucker Humbucker Pickup.
Neck & Bridge. Well balanced frequency response, high dynamics, punchy and warm sound.



Active Humbucker Pickups



EMG-HBCS

Active Bass **HB**, black. P Bass™ pickup in a humbucker housing. Developed for Steinberger Sound for their infamous headless bass.



EMG-P

Active Bass **P**, black. Original active P Bass™ pickup. Covers a wide sonic palette of classic and modern bass sound. Brilliant high-end articulation.



EMG-P-IVO

Active Bass **P**, ivory. Original active P Bass™ pickup. Covers a wide sonic palette of classic and modern bass sound. Brilliant high-end articulation.



EMG-P6

Active Bass **P**, 6-String, black. P Bass™ pickup. Covers a wide sonic palette of classic & modern bass sound. Brilliant high-end articulation.



EMG-PJ-SET

Active Bass **PJ Set**, 4-String, black, Set. Original pickup set for PJ Bass. Provides bass players flexibility with a wide range of tonal combinations.



EMG-P5J-SET

Active Bass **PJ Set**, 5-String, black, Set. Original pickup set for PJ Bass. Provides bass players flexibility with a wide range of tonal combinations.



EMG-J-SET

Active Bass **J Set**, 4-String, black, Set. Original EMG Jazz Bass™ pickup Set. Sweeping harmonic overtones, punch and quiet operation. Classic jazz bass characteristics.



EMG-J5-SET

Active Bass **J5 Set**, 5-String, black, Set. Original EMG Jazz Bass™ pickup Set. Sweeping harmonic overtones, punch and quiet operation. Classic jazz bass characteristics.



EMG-35J

Active Bass **35J**, 4-String, black. EMG's original active Jazz Bass™ pickup in a 3.5" soapbar housing. Sweeping harmonic overtones & punch.



EMG-35DC

Active Bass **35DC**, 4-String, black. Dual coil ceramic magnet 3.5" soapbar. A powerful modern sounding hum. for players looking to cut through a big loud mix.



EMG-40DC

Active Bass **40DC**, 5-String, black. Dual coil ceramic magnet 4" soapbar. Provide punch & clarity with a crisp top end + plenty of output.



EMG-40TW

Active Bass **40TW**, 5-String, black. Split coil soapbar pickup featuring single & humbucking operation. Single coil provide rich, warm tone. Humbucker: aggressive sound.



EMG-45P

Active Bass **45P**, 6-String, black. P Bass™ pickup in a 4.5" soapbar housing. Covers a wide sonic palette of classic and modern bass sounds.



EMG-45J

Active Bass **45J**, 6-String, black. Original Jazz Bass™ pickup in a 4.5" soapbar housing. Gives it sweeping harmonic overtones and punch.



EMG-45JX

Active Bass **45JX**, 6-String, black. EMG's X series Jazz Bass™ pickup in a soapbar pickup housing. Classic jazz bass charact.



EMG-MM-CS

Active Bass **MMCS**, 4-String, black. Active pickup replacement for a Music Man™ bass featuring ceramic and steel magnets.



EMG-MM-TW

Active Bass **MMTW**, 4-String, black. Replacement for a Music Man™ bass with noiseless single & humbucking operation.



EMG-MM5-TW

Active Bass **MMTW**, 5-String, black. Replacement for a Music Man™ bass with noiseless single & humbucking operation.



EMG-TBDC

Active Bass **TBDC**, 4-String, black. Replacement pickup for a Thunderbird™ bass. Excellent frequency range and response.



EMG-TBJ

Active Bass **TBJ**, 4-String, black. Jazz Bass™ pickup in a Thunderbird™ housing. Sweeping harmonic overtones and punch.



EMG-TBP

Active Bass **TBP**, 4-String, black. Replacement pickup for a Thunderbird™ bass with offset coils. Classic & modern bass sounds.



EMG-LJ

Active Bass **LJ**, 4-String, black. Single Coil Jazz Bass Retrofit. Typical Jazz Bass tone with low frequency response.



EMG-LJ5

Active Bass **LJ5**, 5-String, black. Single Coil Jazz Bass Retrofit. Typical Jazz Bass tone with low frequency response.



X-Series Pickups

EMG-PX-BLK

Active Bass **PX**, black. EMG's X series pickup for P Bass™ featuring added headroom. Offers increased touch sensitivity and dynamic range.



EMG-PJX-SET

Active Bass **PJX**, Set, black. PJ Bass pickup set with increased headroom. Provides bass players flexibility and a wide range of tonal combinations, headroom and dynamic response.



EMG-PJAX-SET

Active Bass **PJAX**, Set, black. PJ Bass pickup set with increased headroom (Alnico). Warmth & incredible low end punch + mid-range with dynamic high end response.



EMG-SJ-X

Active Bass **SJ X**, Neck, black. Jazz Bass Single Coil Pickup retrofit. Has classic jazz bass characteristics with a broader tonal frequency range.



EMG-JX-SET

Active Bass **JX**, Set, black. Jazz Bass™ pickup set with added headroom. Classic jazz bass characteristics with dimensions and clarity.



EMG-SJV-X

Active Bass **SJVX**, black. Exposed poles. Deliver the classic tone & look of a vintage Jazz Bass without the noise like vintage passive pickups.



EMG-SJA-X

Active Bass **SJAX**, Neck, black. Based off EMG's original J, but uses radiused Alnico V magnets instead of ceramic and our X Series preamp. Deliver warm and open tone.



EMG-JVX-SET

Active Bass **SJAX**, black. Jazz Bass™ pickups with vintage looks & added headroom. Deliver the classic tone & look without the noise like vintage passive pickups.



EMG-JVX-SET-RED

Active Bass **SJAX**, red. Jazz Bass™ pickups with vintage looks & added headroom. Deliver the classic tone & look without the noise like vintage passive pickups.



EMG-JAX-SET

Active Bass **JAX**, black. Jazz Bass™ pickup with added headroom + Alnico V magnets. Warm and open tone for a more vintage sound.



EMG-35TWX

Active Bass **35TWX**, black, 4-String. Dual mode coil splitting pickup in a 3.5" soapbar. Aggressive sound from hum.. Single coil: rich, warm tone.



EMG-35CSX

Active Bass **35CSX**, black, 4-String. With added headroom, this 3.5" soapbar features ceramic and steel magnets. Provides warmth & punch.



EMG-35DCX

Active Bass **35DCX**, black, 4-String. Ceramic X series 3.5" soapbar pickup with added headroom. Dynamic response + sensitivity, punch and clarity.



EMG-35PX

Active Bass **35PX**, black, 5-String. P Bass™ pickup with increased headroom in a soapbar housing. Sensitivity & dynamic range.



EMG-40CSX

Active Bass **40CSX**, black, 5-String. With added headroom, this X series 4" soapbar uses ceramic & steel magnets.



EMG-40DCX

Active Bass **40DCX**, black, 5-String. Ceramic X series dual coil 4" soapbar bass pickup with added headroom.



EMG-40PX-5

Active Bass **40PX**, black, 5-String. P Bass™ pickup with increased headroom in a soapbar housing. Covers a palette of classic & modern sounds.

Passive Pickups



EMG-P5X-BLK

Active Bass **P5X**, black, 5-String. P Bass™ pickup with add. headroom. Brilliant high-end articulation, warmth, and incredible low end punch.



EMG-LJHZ

Passive Bass **LJHZ**, black. Jazz Bass™ pickup designed for the bridge position. Offers classic passive bass tone & feel with the reliability & frequency range known to EMG.



EMG-JHZ-SET

Passive Bass **JHZ**, black. Jazz Bass™ pickup for those looking for more traditional tone and feel.



EMG-PJHZ-SET

Passive Bass **PJHZ**, black. Combines our PHZ and LJHZ pickups, giving bass players who prefer the response and feel of a passive pickup with the flexibility and tone known to EMG.



EMG-GZR-PHZ

Passive Bass **GZR P**, black, 4-String. Unmistakable early Geezer Butler bass tone with deep, tight low end that you hear on tunes like "Iron Man," "War Pigs," just like 1970's.



EMG-GZR-PJHZ

Passive Bass **GZR PJ**, black, 4-String. Uses Alnico 5 poles and features two custom wound split-coils. Eliminates the noise and hum + allows for more power and volume.



Jazz Bass Pickups

099-2281-000

Yosemite PJ Jazz Bass pickups single-coil Set (3pcs.). Designed for rich, authentic Fender sound. Includes a seismic split-coil P-Bass middle & growling Jazz Bass bridge pickup.



099-2294-000

Ultra Noiseless Vintage Jazz Bass pickups single-coil Set (2pcs.). New winding tech. for livelier and more expansive tone. Deliver a vintage voice with the classic punch.



099-2296-000

Ultra Noiseless Vintage Jazz Bass 5-String pickups single-coil Set (2pcs.). New winding tech. for livelier and more expansive tone. Deliver a vintage voice with the classic punch.



099-2262-000

Gen 4 Noiseless Jazz Bass pickups single-coil Set (2pcs.). Tight low end, clearly defined high end & punchy mids that can power through any mix.



099-2101-000

Custom Shop Custom '60s Jazz Bass pickups Alnico 5 Set (2pcs.). High output, balanced midrange, low end. Classic J-Bass clarity with snarl.



099-2243-000

Pure Vintage '74 Jazz Bass pickups single-coil Set (2pcs.). Versatile vintage voice full of low-end warmth and their distinct midrange.



099-2123-000

Original Jazz Bass pickups Alnico 2 Set (2pcs.). Delivering all the punch and midrange growl that made the Jazz Bass from the '60s so popular.



099-2102-000

Noiseless Jazz Bass pickups Alnico 2, Set (2pcs.). Produce all the brilliant clarity & harmonic attributes of a vintage Jazz Bass without the hum.



Precision Bass Pickups

LAST ONE

099-2284-000

Yosemite Precision Bass pickups, Set (2pcs.). Rich, authentic Fender sound. Expressive, well-defined voice that's highly musical and dynamic.



099-2241-000

Pure Vintage '63 Precision Bass pickups Alnico 5, Set (2pcs.). Sweet low end, remarkable vintage-style tone and performance.



099-2214-000

Custom Shop '62 Precision Bass pickups Alnico 5, Set (2pcs.). Deliver the full booming lows, punchy midrange & clear high end.

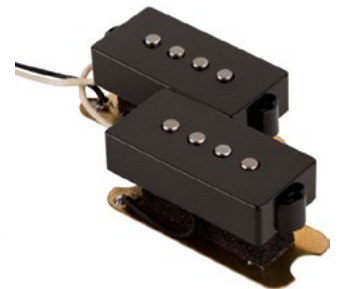

099-2046-000

Original Precision Bass split-coil humbucking pickup, Set (2pcs.). Delivers powerful bass and clear high-end.

KLUSON



PJB10

Pickup, **Vintage for J-Bass**, Bridge, black. Finest vintage Alnico replicas.



PJB20

Pickup, **Vintage for J-Bass**, Neck, black. Finest vintage Alnico replicas.



PJB11

Pickup, **Jaco for J-Bass**, Bridge, black. Finest vintage Alnico replicas! The "Jaco" model has 800 extra turns - best for fretless basses!



PJB5B

Pickup, **5-String for J-Bass**, Bridge, black. Ceramic Magnet. Narrow string spacing (67.7mm).



PPB10

Pickup, **Vintage for P-Bass**, black. Vintage Alnico - still one of the most defined bass sounds!



SSB-4B

Passive Soapbar 4-String Phase II, Bridge, black. A passive 4-string soapbar pickup for your bridge packs quite a big punch.



SSB-4N

Passive Soapbar 4-String Phase II, Neck, black. A passive neck 4-string soapbar pickup that packs punch with organic feel.



SSB-4-SET

Passive Soapbar 4-String Phase II, Set, black. A passive 4-string soapbar pickup set that packs a big punch with organic feel.



SSB-5B

Passive Soapbar 5-String Phase II, Bridge, black. This 5 string bridge version of our Passive soapbar pickups has an organic feels with punch.



SSB-5N

Passive Soapbar 5-String Phase II, Neck, black. This 5 string neck version of our Passive soapbar pickups has an organic feels with punch.



SSB-5-SET

Passive Soapbar 5-String Phase II, Set, black. A passive 5-string soapbar pick-up set that packs quite a big punch.



NYCB-4S

NYC 4-String, Set, black. 3 distinct voices in this passive dual coil pickup, from true vintage J bass, to quiet single coil tone, to max. output & fullness.



NYCB-5S

NYC 5-String, Set, black. 3 distinct voices from True vintage J bass, to maximum output and fullness in this passive pickup.



ASB-5-B

Active Soapbar 5-string Phase I, Bridge, black. Our Phase I sized active 5-string bridge soapbar pickup combines clarity, punch, and warmth in a super-responsive soapbar.



ASB-5-N

Active Soapbar 5-string Phase I, Neck, black. Our Phase I sized active 5-string neck soapbar pickup combines clarity, punch, and warmth in a super-responsive soapbar.



ASB2-5-B

Active Soapbar 5-String Phase II, Bridge, black. This Phase II sized 5-string active bridge soapbar with a Hi-Fi tone and monster attack.



ASB-6-B

Active Soapbar 6-String Phase I, Bridge, black. Our Phase I sized active 6-string bridge soapbar pickup combines clarity, punch, and warmth in a super-responsive soapbar.



ASB-6-N

Active Soapbar 6-String Phase I, Neck, black. Our Phase I sized active 6-string neck soapbar pickup that combines clarity, punch, and warmth in a super-responsive soapbar.



ASB-2ASB

Steve Bailey Active Soapbar, Set, black, 2 band. Steve Bailey signature active soapbar pickup set with 2 band active Tone Circuit system for 6-string electric fretless bass.



ASB-BO-4N

Blackouts Bass Soapbar, black. The active 4 string soapbar pickup brings more tone, more power, and more impact.



ASB-BO-4S

Blackouts Bass Soapbar, Set, black. This 4 string active soapbar pickup matched set brings more tone, more power, and more impact.



ASB-BO-5N

Blackouts Bass Soapbar, Neck, black. The active 5-string soapbar neck pickup brings more tone, more power, and more impact.



ASB-BO-5S

Blackouts Bass Soapbar, black, Set. The active 5-string soapbar pickup set brings more tone, more power, and more impact



AJJ-1

Pro Active Jazz Bass, Set, black. A modern look and voicing that delivers increased output and punch.



AJB-2ASB

Steve Bailey Active Jazz Bass System, Set, black, 2band. Full tonal control with active JJ set & 2band Tone circuit voiced for fretless basses.

Active pickups
for Fender



PJB-SET

Quarter Pound PJ, Set, black. Massive attitude from the Jazz bass neck pickup together with fat full punchy P-bass. Quarter Pounders rule.



APJ-2

Lightnin' Rods PJ, Set, black. Vintage voiced active PJ pickup set with increased output level, and classic exposed pole piece look.



SJB-1-B-BLK

Vintage Jazz Bass, Bridge, black. Vintage correct Jazz Bass single coil bridge pickup made to look and sound like the originals.



SJB-1-N-BLK

Vintage Jazz Bass, Neck, black. Vintage correct Jazz Bass single coil bridge pickup made to look and sound like the originals.

Single Coil pickups
for Jazz Bass



SJB-2-B-BLK

Hot Jazz Bass, Bridge, black. Hot rodded Jazz Bass single coil bridge pickup with increased warmth and growl.



SJB-2-N-BLK

Hot Jazz Bass, Neck, black. Hot rodded Jazz Bass single coil bridge pickup with increased warmth and growl.



SJB-3-B-BLK

Quarter Pound Jazz Bass, Bridge, black. This bridge pickup has quarter-inch diameter Alnico 5 rod magnets to deliver all the attitude you could ever want from a Jazz Bass.



SJB-3-N-BLK

Quarter Pound Jazz Bass, Neck, black. A high-powered neck pickup with 1/4" diameter Alnico 5 rod magnets to deliver all the attitude you could ever want from a Jazz Bass.

Stack pickups
for Jazz Bass



SJB-3-S

Quarter Pound Jazz Bass, Set, black. Quarter-inch diameter Alnico 5 rod magnets and hot coil windings deliver attitude and power.



STK-J1-B-BLK

Classic Stack Jazz Bass, Bridge, black. A noiseless drop-in replacement for any 4-string Fender American Standard Jazz Bass.



STK-J1-N-BLK

Classic Stack Jazz Bass, Neck, black. A noiseless drop-in replacement for any 4-string Fender American Standard Jazz Bass.



STK-J2-B-BLK

Hot Stack Jazz Bass, Bridge, black. Hum-canceling Stack for Jazz Bass with increased output and fatter tone for any 4-string Fender Jazz Bass.

Pickups for 5-String
Jazz Bass



STK-J2-N-BLK

Hot Stack Jazz Bass, Neck, black. Hum-canceling Stack for Jazz Bass with increased output and fatter tone for any 4-string Fender Jazz Bass.



APJB-5S-6770

5 String Apollo 67/70 Jazz Bass, Set, black. Adds punch & articulation missing from standard Jazz bass pickups while minimizing noise.



SJB-5-N-BLK

5 String Stack Jazz Bass, Neck, black. Vintage output passive Stack uses blades instead of individual poles. Deliver a full, noiseless tone.



SJ5-B-67-70

5 String Stack Jazz Bass, Bridge, black. Vintage output bridge position single coil for 5-string Jazz V basses, delivers classic JB warmth and feel.



SJ5-N-67-70

67/70 Jazz Bass, Neck, black. Vintage output neck position single coil for 5-string Jazz V basses with the wider cover size



SJ5-S-67-70

67/70 Jazz Bass, Set, black. Vintage output position single coil for 5-string Jazz V basses, delivers classic Jazz Bass warmth and feel.



SJ5-B-70-74

70/74 Jazz Bass, Bridge, black. Vintage output bridge position single coil for traditional 5-string Jazz Bass. Delivers all of the warmth and feel of a classic Jazz Bass.



SJ5-N-70-74

70/74 Jazz Bass, Neck, black. Vintage output neck position single coil for traditional 5-string Jazz Bass. Delivers all of the warmth and feel of a classic Jazz Bass.



SJ5-S-70-74

70/74 Jazz Bass, Set, black. Vintage output neck and bridge single coil set for traditional 5-string Jazz Bass. Delivers all of the warmth and feel of a classic Jazz Bass.



SJ5-3B

Quarter Pound Jazz Bass, Bridge, black. 5-string bridge pickup with diameter alnico 5 rod magnets delivers all the attitude you could ever want from a Jazz Bass.



SJ5-3N

Quarter Pound Jazz Bass, Neck, black. 5-string neck pickup with diameter alnico 5 rod magnets delivers all the attitude you could ever want from a Jazz Bass.



AJB-5-B

Active 5 String Stack Jazz Bass, Bridge, black. Active 5-string Jazz Bass pickup with an even voicing, and increased output.



AJB-5-N

Active 5 String Stack Jazz Bass, Neck, black. Active 5-string Jazz Bass pickup with an evenly voiced tone, and increased output.



AJB-5S-BLK

Active 5 String Stack Jazz Bass, Set, black. Active 5-string Jazz Bass pickup set with an even voicing, and increased output.



SPB-1

Vintage P-Bass, Set, black. Vintage correct split-coil Precision Bass pickup made to look and sound like the late 50s originals.



SPB-2

Hot P-Bass, Set, black. Hot rodded split-coil P-Bass pickup with added warmth and punch gives you a bigger, meaner tone than the Vintage model.

Pickups
for P-Bass



SPB-3

Quarter Pound P-Bass, Set, black. Large diameter alnico 5 rod magnets & a high output coil wind deliver the most tone and attitude you ever want.



SPB-4

Steve Harris P-Bass, Set, black. When metal's most legendary P-Bass player needs a pickup that is both detailed and powerful.



SCPB-1-BLK

Vintage Single Coil P-Bass, black. Vintage correct single-coil Precision Tele Bass pickup made to look & sound like the early 50s originals.



SCPB-3-BLK

Quarter Pound Single Coil P-Bass, black. High output true single coil for Tele Bass delivers a nice growl and an aggressive attack.

Single Coil
for P-Bass

Pickups for
Music Man Bass



SCPB-5

Quarter Pound Single Coil P-Bass, Set, black, 5-String. High output coil wind deliver the most tone & attitude you could ever want in a 5-string P-Bass pickup.



SMB-4A

Music Man - Alnico V, black. This 4-string Music Man Stingray replacement is voiced like the original 70s Stingrays, for a more organic response and feel.



SMB-4A-3C

Music Man - 3coil Alnico V, black. 3-coil alnico magnet direct replacement for 4-string Music Man basses with a 3-coil pickup and a 3-way blade switch.



SMB-4D

Music Man - Ceramic, black. Modern replacement for 4-string Sting Ray basses, this pickup is punchy and aggressive, like the 90s Ernie Ball Music Man era.

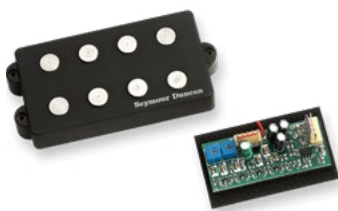

SMB-4DS

Music Man System - Ceramic 3 Knobs, black. Complete replacement system for 4-string Sting Ray basses. With our ceramic 4-string pickup & our 3-knob Music Man Tone Circuit.



SMB-5A

Music Man - 5 Strg Alnico V, black. This 5-string Music Man Stingray replacement uses alnico 5 rods and is voiced like the original '70s Stingrays, for a more organic response and feel.



SMB-5D

Music Man - 5 Strg Ceramic, black. Modern replacement for 5-string Sting Ray basses, this pickup is punchy and aggressive, like the 90s Ernie Ball Music Man era.



SMB-5DS

Music Man System - 5 Strg Ceramic, 4 Knobs, black. Complete replacement system for 5-string Sting Ray basses. With our ceramic 5-string pickup, and our 4-knob Music Man Tone Circuit.

Humbuckers for
Rickenbacker Bass



SRB-1-B-BLK

Rickenbacker Humbucker, Bridge, black. Our Rickenbacker replacement adds output & hum-canceling. Great for all styles of music.



SRB-1-N-NKL

Rickenbacker Humbucker, Neck, nickel. Upgrade for 4000 series basses. Adds output & hum-canceling. Great for all styles of music.

Electronic Tone
Circuits - Bass



STC-2A

Active Bass Preamp - Active Voiced 2band. High headroom, low-noise designed for use with active pickups. Prewired 3-knob harness.



STC-2P

Active Bass Preamp - Passive Voiced 2band. High headroom, low-noise designed for use with passive pickups. Prewired 3-knob harness.



STC-3A

Active Bass Preamp - Active Voiced 3band. High headroom, low-noise designed for use with active pickups. 4-knob harness.



STC-3P

Active Bass Preamp - Passive Voiced 3band. High headroom, low-noise designed for use with passive pickups. Prewired 4-knob harness.

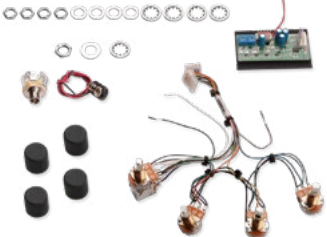

STC-3M4

Music Man Active Preamp - 3band 4 Knobs. Tone Circuit designed for Music Man Stingray bass comes with a prewired 4-knob control harness.



PICKUP COVERS AND SUPPLIES



Pickup-Ring



PLDTB

For LittleToaster, black. Outer dimensions of the Toaster mounting rings = standard hum. rings. A Due-senberg pickup angler is included.



PMD4B

3-Step Pickupring, neck, black. Included screw and brass. Size: 88-89 x 45mm (plus 3mm at the angler screw), Height 4mm.



PMD4S

3-Step Pickupring, neck, silver-plexi. Included screw and brass. Size: 88-89 x 45mm (plus 3mm at the angler screw), Height 4mm.



PMD4K

3-Step Pickupring, neck, cream. Included screw and brass. Size: 88-89 x 45mm (plus 3mm at the angler screw), Height 4mm.



PMD4G

3-Step Pickupring, neck, gold-plexi. Included screw and brass. Size: 88-89 x 45mm (plus 3mm at the angler screw), Height 4mm.



PMD5B

3-Step Pickupring, Bridge, black. Included screw and brass. Size: 91-92 x 45mm (plus 3mm at the angler screw), Height 5mm..



PMD5S

3-Step Pickupring, Bridge, silver-plexi. Included screw and brass. Size: 91-92 x 45mm (plus 3mm at the angler screw), Height 5mm..



PMD5K

3-Step Pickupring, Bridge, cream. Included screw and brass. Size: 91-92 x 45mm (plus 3mm at the angler screw), Height 5mm..



PMD5G

3-Step Pickupring, Bridge, gold-plexi. Included screw and brass. Size: 91-92 x 45mm (plus 3mm at the angler screw), Height 5mm.



Flat Mounting Rings Humbucker



EMG-F6-T-black

Flat 6 Thin, neck, black, 6-String. Designed specifically for EMG pickups but is a direct replacement for standard full sized humbucking pickups.



EMG-F6-T-ivory

Flat 6 Thin, neck, ivory, 6-String. Designed specifically for EMG pickups but is a direct replacement for standard full sized humbucking pickups.



EMG-F6-T-white

Flat 6 Thin, neck, white, 6-String. Designed specifically for EMG pickups but is a direct replacement for standard full sized humbucking pickups.



EMG-F6-M-black

Flat 6 Medium, middle, black, 6-String. Specifically for EMG pickups, a direct replacement for standard full sized humbucking pickups.



EMG-F6-M-ivory

Flat 6 Medium, middle, ivory, 6-String. Specifically for EMG pickups, a direct replacement for standard full sized humbucking pickups.



EMG-F6-M-white

Flat 6 Medium, middle, white, 6-String. Specifically for EMG pickups, a direct replacement for standard full sized humbucking pickups.



EMG-F7-T-black
Flat 7 Thin, neck, black, 7-String.
 Specifically for EMG pick-ups, a direct replacement for 7-Strg sized humbucking pickups.



EMG-F7-T-ivory
Flat 7 Thin, neck, ivory, 7-String.
 Specifically for EMG pick-ups, a direct replacement for 7-Strg sized humbucking pickups.



EMG-F7-T-white
Flat 7 Thin, neck, white, 7-String.
 Specifically for EMG pick-ups, a direct replacement for 7-Strg sized humbucking pickups.



EMG-F7-M-black
Flat 7 Medium, middle, black, 7-String. Specifically for EMG pick-ups, a direct replacement for 7-Strg sized humbucking pickups.



EMG-F7-M-ivory
Flat 7 Medium, middle, ivory, 7-String. Specifically for EMG pick-ups, a direct replacement for 7-Strg sized humbucking pickups.



EMG-F7-M-white
Flat 7 Medium, middle, white, 7-String. Specifically for EMG pick-ups, a direct replacement for 7-Strg sized humbucking pickups.



EMG-F8-T-black
Flat 8 Thin, neck, black, 8-String.
 Specifically for EMG pick-ups, a direct replacement for 8-Strg sized humbucking pickups.



EMG-F8-T-ivory
Flat 8 Thin, neck, ivory, 8-String. Specifically for EMG pick-ups, a direct replacement for 8-Strg sized humbucking pickups.



EMG-F8-T-white
Flat 8 Thin, neck, white, 8-String. Specifically for EMG pick-ups, a direct replacement for 8-Strg sized humbucking pickups.



EMG-F8-M-black
Flat 8 Medium, middle, black, 8-String. Specifically for EMG pick-ups, a direct replacement for 8-Strg sized humbucking pickups.



EMG-F8-M-ivory
Flat 8 Medium, middle, ivory, 8-String. Specifically for EMG pick-ups, a direct replacement for 8-Strg sized humbucking pickups.



EMG-F8-M-white
Flat 8 Medium, middle, white, 8-String. Specifically for EMG pick-ups, a direct replacement for 8-Strg sized humbucking pickups.

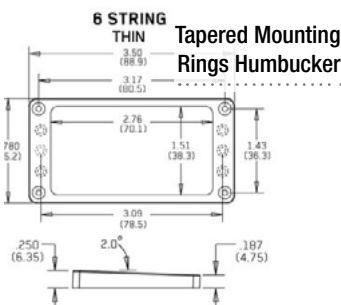

EMG-T6-T-black
Tapered 6 Thin, neck, black, 6-String. For EMG pickups, a direct replacement for standard full sized humbucking pickups.

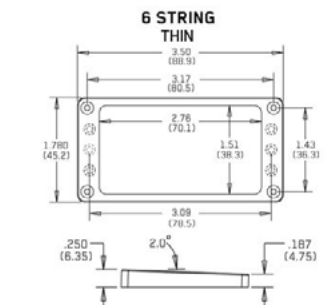

EMG-T6-T-ivory
Tapered 6 Thin, neck, ivory, 6-String. For EMG pickups, a direct replacement for standard full sized humbucking pickups.

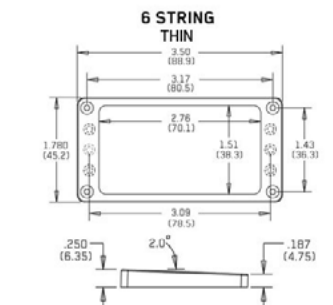

EMG-T6-T-white
Tapered 6 Thin, neck, white, 6-String. For EMG pickups, a direct replacement for standard full sized humbucking pickups.

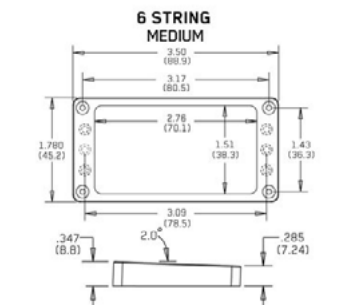

EMG-T6-M-black
Tapered 6 Medium, middle, black, 6-String. For EMG pickups, a direct replacement for standard full sized humbucking pickups.

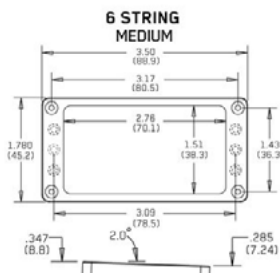

EMG-T6-M-ivory

Tapered 6 Medium, middle, ivory, middle, 6-String. For EMG pickups, a direct replacement for standard full sized humbucking pickups.

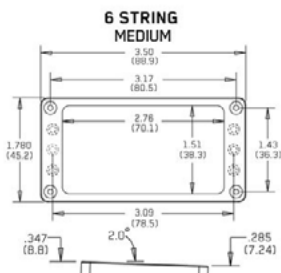

EMG-T6-M-white

Tapered 6 Medium, middle, white, 6-String. For EMG pickups, a direct replacement for standard full sized humbucking pickups.

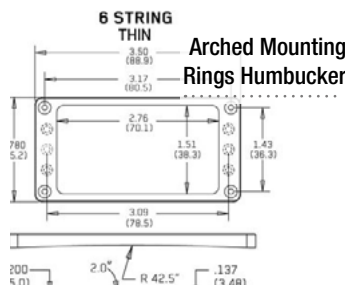

EMG-A6-T-black

Arched 6 Thin, neck, black, 6-String. For EMG pickups, a direct replacement for standard full sized humbucking pickups.

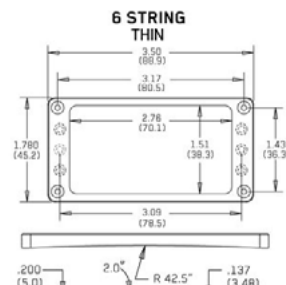

EMG-A6-T-ivory

Arched 6 Thin, neck, ivory, 6-String. For EMG pickups, a direct replacement for standard full sized humbucking pickups.

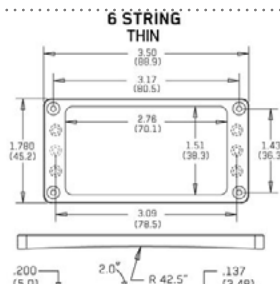

EMG-A6-T-white

Arched 6 Thin, neck, white, 6-String. For EMG pickups, a direct replacement for standard full sized humbucking pickups.

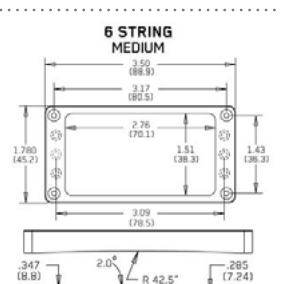

EMG-A6-M-black

Arched 6 Medium, middle, black, 6-String. For EMG pickups, a direct replacement for standard full sized humbucking pickups.

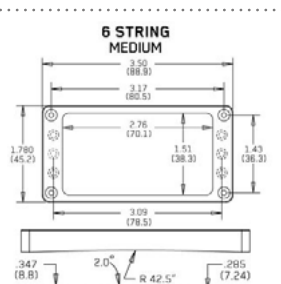

EMG-A6-M-ivory

Arched 6 Medium, middle, ivory, 6-String. For EMG pickups, a direct replacement for standard full sized humbucking pickups.

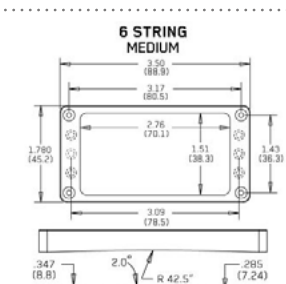

EMG-A6-M-white

Arched 6 Medium, middle, white, 6-String. For EMG pickups, a direct replacement for standard full sized humbucking pickups.



**Pickup Covers
Strat**

**Pickup Covers
Basses**



099-1364-000

Stratocaster® Pickup Cover, black. Set of 3 pickup covers for a variety of vintage & contemporary Strat. Don't fit SCN™, N3™ & Noiseless™ pickups.



099-2034-000

Stratocaster® Pickup Cover, white. Set of 3 pickup covers for a variety of vintage & contemporary Strat. Don't fit SCN™, N3™ & Noiseless™ pickups.



099-2270-100

Pure Vintage Stratocaster® Bridge Cover, steel. Fits most Stratocaster guitars with vintage-style tremolo bridges; will not fit left-hand models.



001-0660-090

American Vintage Jazz Bass Pickup Cover, chrome. Fits American Vintage, Road Worn and Classic Series basses.



001-0678-000

Vintage-Style Jazz Bass F Bridge Cover, chrome. Fits American Vintage, Road Worn and Classic Series basses. «F» logo displayed on the front.



099-2088-000

Pure Vintage Jazz Bass Ashtray Cover Set, chrome. Fits most vintage and modern Jazz Bass guitars; will not fit five-string models.



001-0108-000

American Vintage P-Bass Bridge Covers, chrome. Fits American Vintage, Road Worn & Classic Series basses; will not fit five-string models.



099-2038-000

Pure Vintage Jazz Bass Plastic Pickup Cover Set, black. Fits most vintage + modern Jazz Bass; will not fit 5-string models or N3 Noiseless.

Stratocaster Accessory Kits



099-1362-000
Vintage-Style Stratocaster® Accessory Kit, white. Contains vintage-style control knobs, switch and trem arm tips, back plate and pickup covers.



099-1363-000
Stratocaster® Accessory Kits, black. Contains control knobs, switch and trem arm tips, back plate and pickup covers.



099-1395-000
Stratocaster® Accessory Kits, parchment. Contains control knobs, switch and trem arm tips, back plate and pickup covers.

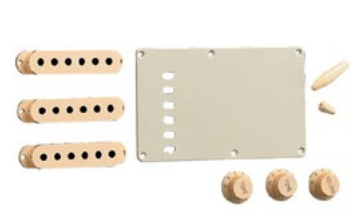

099-1368-000
Stratocaster® Accessory Kits, aged white. Contains control knobs, switch and trem arm tips, back plate and pickup covers.



099-2096-000
Pure Vintage '50s Stratocaster® Accessory Kit. Includes eggshell-colored tone and volume knobs, pickup covers, tremolo arm tip and switch tip (backplate sold separately).



099-2097-000
Pure Vintage '60s Stratocaster® Accessory Kit. Includes vintage white tone and volume knobs, pickup covers, tremolo arm tip and switch tip (backplate sold separately).

goldo P90 Covers



PC87B
Underlayer Set for P90 Dog Ear, black. For raising P-90 Dog Ears. Two rings, for bridge and neck pickup.



PC90B
Cover for P90 Soapbar, black.

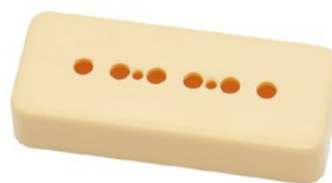

PC90K
Cover for P90 Soapbar, cream.



PC91B
P90 Dog Ear Cover, Bridge, black. Covers for Dog Ear Pickups.



PCCASF
P90 Dog Ear Cover, Neck, nickel.



PCCASR
P90 Dog Ear Cover, Bridge, nickel.

Humbuckers Covers + Rings



PC1AC
Retromatic Humbucker-Cover, transparent. You can spray the "see through Retromatic" covers from inside. Unlimited colors!



PL10B
Humbucker Mounting Ring, low, black. For flat tops, 88,5 x 44,6mm, Height 3,6 to 5,5mm



PL10K

Humbucker Mounting Ring, low, cream. For flat tops, 88,5 x 44,6mm, Height 3,6 to 5,5mm



PL11B

Humbucker Mounting Ring, high, black. For flat tops, 88,5 x 44,6mm, height 8,9 to 10,8mm



PL11K

Humbucker Mounting Ring, high, cream. For flat tops, 88,5 x 44,6mm, height 8,9 to 10,8mm



PL15B

Humbucker Mounting Ring for Arched Tops, low, black. 92 x 46mm, height 5,2 to 5,5mm



PL15K

Humbucker Mounting Ring for Arched Tops, low, cream. 92 x 46mm, height 5,2 to 5,5mm



PL16B

Humbucker Mounting Ring for Arched Tops, high, black. 92 x 46mm, height 5,2 to 5,5mm



PL16K

Humbucker Mounting Ring for Arched Tops, high, cream. 92 x 46mm, height 5,2 to 5,5mm



PL1UB

Humbucker Mounting Ring, black. For flat or arched bodies, plastic, 88,5 x 44,6 x 2,5mm parallel



PL1UC

Humbucker Mounting Ring, chrome plated. For flat or arched bodies, plastic, 88,5 x 44,6 x 2,5mm parallel



PL1UG

Humbucker Mounting Ring, gold plated. For flat or arched bodies, plastic, 88,5 x 44,6 x 2,5mm parallel



PNS0B

German Silver Cover for Humbucker, black. Made with the only metal that does not influence the electromagnetic characteristics of a pickup.



PNS0C

German Silver Cover for Humbucker, chrome. Made with the only metal that does not influence the electromagnetic charact. of a pickup.



PNS0N

German Silver Cover for Humbucker, nickel. Made with the only metal that does not influence the electro-magnetic charact. of a pickup.



PNS0G

German Silver Cover for Humbucker, gold. Made with the only metal that does not influence the electro-magnetic charact. of a pickup.



PNS0A

German Silver Cover for Humbucker, «antique». Made with the only metal that does not influence the electro-magnetic charact. of a pickup.



PNS1C

German Silver Cover for Humbucker, 49,2mm, chrome. Made with the only metal that doesn't influence the electro-magnetic charact. of a pickup.



PNS1N

German Silver Cover for Humbucker, 49,2mm, nickel. Made with the only metal that doesn't influence the electro-magnetic charact. of a pickup.



PNS1G

German Silver Cover for Humbucker, 49,2mm, gold. Made with the only metal that doesn't influence the electro-magnetic charact. of a pickup.



PNS1A

German Silver Cover for Humbucker, 49,2mm, «antique». Made with the only metal that doesn't influence the electro-magnetic charact. of a pickup.



PNS2C

German Silver Cover for Humbucker, 50mm, chrome. Made with the only metal that doesn't influence the electro-magnetic charact. of a pickup.



PNS2N

German Silver Cover for Humbucker, 50mm, nickel. Made with the only metal that doesn't influence the electro-magnetic charact. of a pickup.



PNS2G

German Silver Cover for Humbucker, 50mm, gold. Made with the only metal that doesn't influence the electro-magnetic charact. of a pickup.



PNS2A

German Silver Cover for Humbucker, 50mm, «antique». Made with the only metal that doesn't influence the electro-magnetic charact. of a pickup.



PNS3C

German Silver Cover for Humbucker, 52.8mm, chrome. Made with the only metal that doesn't influence the electro-magnetic charact. of a pickup.



PNS3N

German Silver Cover for Humbucker, 52.8mm, nickel. Made with the only metal that doesn't influence the electro-magnetic charact. of a pickup.



PNS3G

German Silver Cover for Humbucker, 52.8mm, gold. Made with the only metal that doesn't influence the electro-magnetic charact. of a pickup.



PNS3A

German Silver Cover for Humbucker, 52.8mm, «antique». Made with the only metal that doesn't influence the electro-magnetic charact. of a pickup.



PNS4C

German Silver Cover for Humbucker, open, chrome. Made with the only metal that doesn't influence the electro-magnetic charact. of a pickup.



PNS4N

German Silver Cover for Humbucker, open, nickel. Made with the only metal that doesn't influence the electro-magnetic charact. of a pickup.



PNS4G

German Silver Cover for Humbucker, open, gold. Made with the only metal that doesn't influence the electro-magnetic charact. of a pickup.



PU03B

Cover for Humbucker, plastic, black. 70 x 38.5 x 20mm. No holes for pole pieces!



PL18C

Metal Mounting Ring for Firebird / Mini Humbuckers, chrome.



PL17B
Humbucker Mounting Ring,
7-string, high, black.



PL27B
Humbucker Mounting Ring,
7-string, low, black.



Single Coils
Covers + Rings
PCJMW
2 Pickup Cover for Jazzmaster,
white. 2 pieces.



PLS1B
Metal Mounting Rings for SC
Pickup, black.



PLTTC
Mounting Ring for Tele Bridge
Pickup, chrome. All the holes to
be drilled are INSIDE the area of a
vintage Tele bridge.



PNSTC
Cover for Tele neck pickup, chrome.
German Silver - No loss of treble! THE
investment for better sound! Because
only nickel silver doesn't alter the
electric values of a pickup.



PNSTG
Cover for Tele neck pickup, gold.
German Silver - No loss of treble! THE
investment for better sound! Because
only nickel silver doesn't alter the
electric values of a pickup.



PLS8V
Vintage Plastic Set for Strat, aged.
Make your Strat look really vintage!
3 covers, 1x Vol, 2x Tone, switch +
arm tip!



PU00C
Closed Cap for Strat Pickup,
chrome. Closed cap for Strat style
pickups, made of German Silver. Low
height (approx. 12mm)



PU00N
Closed Cap for Strat Pickup, nickel.
Closed cap for Strat style pickups,
made of German Silver. Low height
(approx. 12mm)



PU00G
Closed Cap for Strat Pickup, gold.
Closed cap for Strat style pickups,
made of German Silver. Low height
(approx. 12mm)



PU00A
Closed Cap for Strat Pickup,
«antique». Closed cap for Strat style
pickups, made of German Silver. Low
height (approx. 12mm)



PU01B
Plastic Cover for Strat Pickup,
black. E' - E string = 52mm /
10,4mm string spacing



PU01W
Plastic Cover for Strat Pickup,
white. E' - E string = 52mm /
10,4mm string spacing



PU01C
Plastic Cover for Strat Pickup,
chrome. E' - E string = 52mm /
10,4mm string spacing

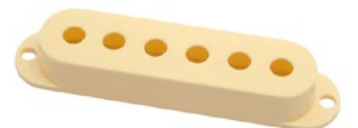

PU01K
Plastic Cover for Strat Pickup,
cream. E' - E string = 52mm /
10,4mm string spacing



PU01A
Plastic Cover for Strat Pickup,
 aged white. E' - E string = 52mm /
 10,4mm string spacing



PU02B
Plastic Cover for Strat Pickup,
 black. Without pole piece holes!



PU02C
Plastic Cover for Strat Pickup,
 open, chrome. Without pole piece
 holes!



PU02N
Plastic Cover for Strat Pickup,
 open, nickel. Without pole piece
 holes!

Covers for Bass



PU02G
Plastic Cover for Strat Pickup,
 open, gold. Without pole piece holes!



PCJBB
Cover for Jazz Bass Pickup, Bridge.
 Black plastic.



PCJNB
Cover for Jazz Bass Pickup, Neck.
 Black plastic.



PCP8B
Covers for PB Pickups, 1 pair, black.

Pickup Supplies,
 Screws, Springs



PL000
Foam rubber for pickups, 1 meter
 1m x 10mm x 13mm. «Mounting
 spring», directly attached to the body
 without a mounting ring.



SR120
Pickup Spring, conical, 50 pieces.
 Universal, 22 mm, conical.



SR125
Pickup Spring for Humbuckers,
 50 pieces. For humbuckers, 31 mm.



SR12F
Pickup Spring for Strat, 50 pieces.
 For Strat pickups, 12 mm.



Strat Pickup
 Covers



SPC-BLK
Strat Cover, black. Stratocaster
 pickup cover with Seymour Duncan
 logo printed in silver.



SPC-WHT
Strat Cover, white. Stratocaster
 pickup cover with Seymour Duncan
 logo printed in silver.



SPC-AGD
Strat Cover, parchment. Stratocaster
 pickup cover without logo.

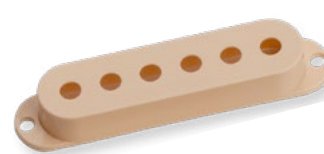

SPC-CRM
Strat Cover, cream. Stratocaster
 pickup cover without logo.



Strat Pickup Covers



SSC-BLK
Strat Stack Cover, black. Stratocaster Stack pickup cover, no logo.

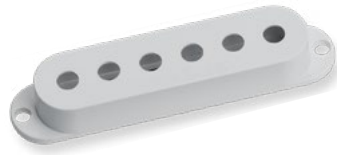

SSC-WHT
Strat Stack Cover, white. Stratocaster Stack pickup cover, no logo.

Humbucker Covers + Mounting Rings



11800-20-Nc
Humbucker cover, nickel. Fits all regular 6-string humbucker models.



411230
Humbucker Livewire cover, black. Pickup Plastic Cover Molded. Fits most LiveWire humbucker models.

Trembucker Covers + Mounting Rings



418001
Mounting Ring Plastic, black. Active Humbucker & Trembucker. Fits Blackouts and all TB Trembucker spaced models.



418005
Mounting Ring Plastic, neck, black. Humbucker Antiquity. Fits all SH Standard Spaced neck humbuckers



418006
Mounting Ring Plastic, bridge, black. Humbucker Antiquity. Fits all SH Standard Spaced bridge humbuckers



11800-21-Nc
Trembucker cover, nickel. Fits most F-spaced Seymour Duncan trembucker models that begin with TB.

Triple Shots Mounting Rings

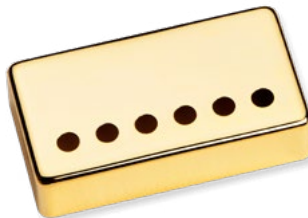

11800-21-Gc
Trembucker cover, gold. Fits most F-spaced Seymour Duncan trembucker models that begin with TB.



TS-1-BLK
Triple Shot Mounting Ring, Flat, black, Trembucker spacing. Wiring mods made easy with four different sounds at tips of your fingers.



TS-1-CRM
Triple Shot Mounting Ring, Flat, cream, Trembucker spacing. Wiring mods made easy with four different sounds at tips of your fingers.



TS-1S-BLK
Triple Shot Mounting Ring, Flat, Set, black, Trembucker spacing. Wiring mods made easy with four different sounds at tips of your fingers.

LesPaul Triple Shots Mounting Rings

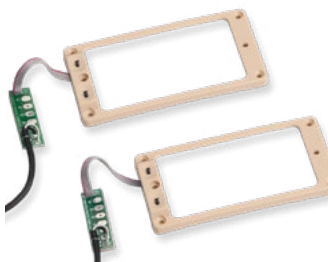

TS-1S-CRM
Triple Shot Mounting Ring, Flat, Set, cream, Trembucker spacing. Wiring mods made easy with four different sounds at tips of your fingers.



TS-2N-BLK
Triple Shot Mounting Ring, neck, black. Wiring mods made easy with four different sounds at tips of your fingers.



TS-2N-CRM
Triple Shot Mounting Ring, neck, cream. Wiring mods made easy with four different sounds at tips of your fingers.



TS-2B-BLK
Triple Shot Mounting Ring, bridge arched, black. Wiring mods made easy with four different sounds at tips of your fingers.

J-Bass Pickup Covers



TS-2B-CRM

Triple Shot Mounting Ring, bridge arched, cream. Wiring mods made easy with four different sounds at tips of your fingers.



TS-2S-BLK

Triple Shot Mounting Ring, Set, black. Wiring mods made easy with four different sounds at tips of your fingers.

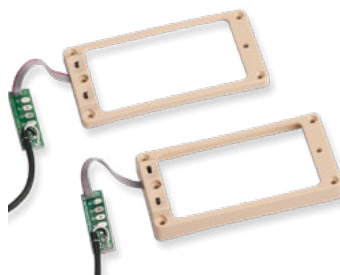

TS-2S-CRM

Triple Shot Mounting Ring, Set, cream. Wiring mods made easy with four different sounds at tips of your fingers.



JBCN-BLK

J-Bass Pickup Cover, neck, black. Vintage style black 4 string Jazz Bass neck pickup covers with no logo.



JBCB-BLK

J-Bass Pickup Cover, bridge, black. Vintage style black 4 string Jazz Bass bridge pickup covers with no logo.



JBCN-Bassline

J-Bass Pickup Cover «Bassline Logo», black. 4 string Jazz Bass pickup covers with «Bassline» logo.



JBC-5-BLK-70

SWD Plastic Cover (height 70mm) «Bassline Logo», black. 5 string Jazz Bass pickup covers with «Bassline» logo.



JBC-5-BLK-74

SWD Plastic Cover (height 74mm) «Bassline Logo», black. 5 string Jazz Bass pickup covers with «Bassline» logo.

P-Bass Pickup Covers



PBC-BLK

P-Bass Pickup Cover, Set, black. Vintage style black P-Bass pickup covers..





Fender-style switches & knobs



ELHD3

Switch for Strat/Tele, 3-way. Solid F-style switch with an especially precise mechanism. A firm flat spring assures a strong audio connection in each position.



ELHD5

Switch for Strat/Tele, 5-way. Solid F-style switch with an especially precise mechanism. A firm flat spring assures a strong audio connection in each position.



ELK3N

Switch tip, nickel. Metal switch tip with allen screw, fits on Fender-style switches and toggle switches.



ELK3G

Switch tip, gold. Metal switch tip with allen screw, fits on Fender-style switches and toggle switches.

Standard Pots



EL5A

Speed Pot, 250K log, 70°. For use as a tone pot. Threads 10x8mmØ, housing 24mmØ, knurled shaft

Metal knobs



KBD3B

Knob, 22mmØ x 16.5mm, black. The official Duesenberg knob! 22mmØ x 16.5mm, 6.1mm hole.



KBD3C

Knob, 22mmØ x 16.5mm, chrome. The official Duesenberg knob! 22mmØ x 16.5mm, 6.1mm hole.



KBD3N

Knob, 22mmØ x 16.5mm, nickel. The official Duesenberg knob! 22mmØ x 16.5mm, 6.1mm hole.



KBD3G

Knob, 22mmØ x 16.5mm, gold. The official Duesenberg knob! 22mmØ x 16.5mm, 6.1mm hole.



KBD4N

Knob, 18mmØ x 16.5mm, nickel. 6.1mm hole.



KBD5N

Knob, 18mmØ x 20mm, nickel. 6.1mm hole.



KBDEN

Knob, 18mmØ x 20mm, nickel. 6.4mm hole.



KBDFN

Knob, 18mmØ x 12mm, nickel. 6.1mm hole.



KBDSN

Knob f. Rotary Switch, 18mmØ x 12mm, nickel. Like KBDFN, but with a slightly upward angled arm (24mm). 6mm shaft

Dunlop

Standard Pots

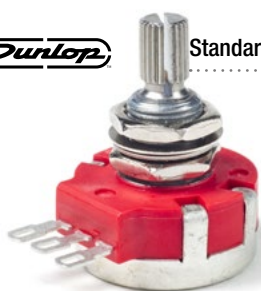
**DSP250K**

Potentiometer 250K, Super Pot Split Shaft. High-perf. vol./tone pots that are made to last a lifetime. Provide a smooth audio-style taper that will never sound noisy or scratchy.

**DSP250S**

Potentiometer 250K, Super Pot Solid Shaft. High-perf. vol./tone pots that are made to last a lifetime. Provide a smooth audio-style taper that will never sound noisy or scratchy.

**DSP500K**

Potentiometer 500K, Super Pot Split Shaft. High-perf. vol./tone pots that are made to last a lifetime. Provide a smooth audio-style taper that will never sound noisy or scratchy.

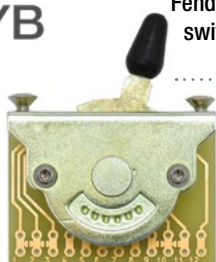
EYBFender-style
switches &
knobs**EL007**

Megaswitch 3.0 E, 5-way. Recommended for wirings with 2 humbuckers, humb./singlecoil/singlecoil, humb./singlecoil/humb. or 3 singlecoils

**EL008**

Megaswitch 3.0 P, 5-way. Offers the sounds of the Paul Reed Smith wiring on a 5-way switch instead of the original rotary switch.

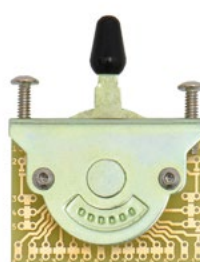
**EL4X5**

Megaswitch 3.0 M, 4x5-way. Offers 4 independent switching layers with 5 contacts on each. Smaller than a standard 5-way switch & has large, gold anodized soldering contacts.

Fender

Output Jacks

**002-1956-049**

1/4" 2-Conductor Guitar Output Jack. Standard 1/4" output jack with mounting hardware for use on most Fender from 1952-present.

**005-6055-049**

Fishman Output Jack, w/ Hardware. 1/4" 3-conductor output jack w/ internal «4th pin». Work with active electronics. Includes mounting.



Jack Plates

099-1940-100

Strat® Jack Ferrules, chrome. For use on nearly all US- & Mexico-made Strato from 1954-present. Mounting hardware included.

**099-1940-200**

Strat® Jack Ferrules, gold. For use on nearly all US- & Mexico-made Strato from 1954-present. Mounting hardware included.

Standard Pots

**099-1941-000**

Tele® Jack Ferrules, nickel. For use on nearly all U.S.- and Mexico-made Telecaster guitars manufactured from 1952-present. Mounting hardware included.

**099-0830-000**

Pure Vintage 250K Split Shaft Pot (Vol. or Tone). Vintage-accurate 250K 3/8" CTS split shaft pot for vol. or tone control.

**099-0831-000**

Pure Vintage 250K Solid Shaft Pot. (Vol. or Tone). Vintage-accurate 250K 3/8" CTS solid shaft pot for vol. or tone control.

**099-0832-000**

250K No Load Split Shaft Pot. An integral part of the Delta Tone™ system on Fender American series guitars. 3/8" split-shaft design.



099-0833-000
250K No Load Solid Shaft Pot. Fits most US- & Mexico-made instruments requiring a 3/8" solid-shaft potentiometer.



004-9441-000
250K Pickup Pan Pot. Used to blend middle and bridge pickups on Deluxe and American Deluxe series basses manufactured from 1997-present.

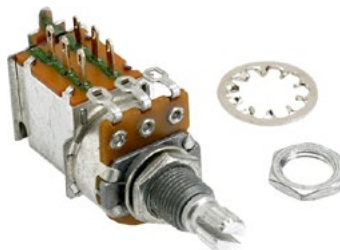

099-2257-000
250K Push/Pull Pot. Lets you add a coil tap or phase switch to your guitar without drilling extra holes. Mounting hardware included.



099-2052-000
TBX Tone Control Pot. Kit. 250K/1Meg potentiometer, No battery necessary, white «tone» control knob included, .022mf capacitor +1/4-watt resistor included.



099-0834-000
500K Split Shaft Pot. (Vol. or Tone). For use as volume or tone control on nearly all U.S.- and Mexico-made Fender instruments with split-shaft potentiometers



099-0835-000
500K Solid Shaft Pot. (Vol. or Tone). For use as volume or tone control on nearly all U.S.- and Mexico-made Fender instruments with solid-shaft potentiometer.



001-9268-049
Concentric 250K-500K Solid Shaft Pot. Used for stacked volume controls on American Vintage '62 Jazz Bass® and Acoustasonic Telecaster®, and Nashville Power Telecaster® guitars.



005-4458-049
Control Mini Pot 50K, Jaguar/Jazzmaster. For use on Fender Basses Jaguar / Jazzmaster.



004-9443-049
100k linear taper control pot. Used as a mid boost control on most Deluxe Series basses (Mexico + US) with active electronics manufactured from 1997-Present.



009-5704-049
Pure Vintage 1 Meg Solid Shaft Control. Fits most Jaguar, Jazzmaster and humbucking pickup-equipped Telecaster® guitars.



001-9066-049
Pure Vintage 1 Meg Audio Taper Control. Taper control for vol. or tone. Fits most Jaguar, Jazzmaster & humbucking pickup-equipped Tele®.



001-6436-049
Potentiometer Locking Washers. Same top-quality potentiometer parts that are used for U.S.-made Fender® instruments. Ø3/8"'''



001-6352-049
Potentiometer Nuts. Set of 12 hex nuts - Ind. internal Ø3/8-32 x 3/32". Same top-quality parts used for U.S.-made Fender instruments.

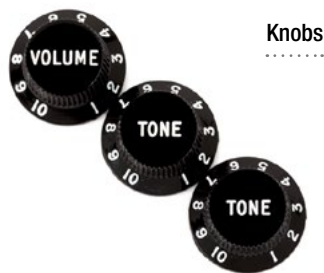

099-1365-000
Stratocaster® Knobs, black. Set of 3 plastic push-on control knobs designed to fit 1/4" split-shaft pot. For US+Mex. Strat from 1954-present.



099-2035-000
Stratocaster® Knobs, white. Set of 3 plastic push-on control knobs designed to fit 1/4" split-shaft pot. For US+Mex. Strat from 1954-present.



005-6254-049
Stratocaster® Knobs, parchment. Set of 3 plastic push-on control knobs designed to fit 1/4" split-shaft pot. For US+Mex. Strat from 1954-present.

**099-1369-000**

Stratocaster® Knobs, aged white. Set of 3 plastic push-on control knobs designed to fit 1/4" split-shaft pot. For US+Mex. Strat from 1954-present.

**005-9267-029**

Stratocaster® S-1™ Switch Knob-Cap Assembly, black. Use with S-1™ switch, fits 1/4" split shaft controls. Can be use on US + Mex. Strat from 1954-present.

**005-9267-049**

S-1™ Switch Stratocaster® Knobs, 2pces, parchment. Use with S-1™ switch, fits 1/4" split shaft controls. Can be use on US + Mex. Strat from 1954-present.

**005-9266-049**

S-1™ Switch Stratocaster® Knob Caps, 2pces, parchment. Can be use on US + Mex. Strat from 1954-present.

**005-9267-030**

S-1™ Switch Stratocaster® Knobs, pce, aged white. Use with S-1™ switch, fits 1/4" split shaft controls. Can be use on US + Mex. Strat from 1954-present.

**005-9266-049**

S-1™ Switch Stratocaster® Knob Caps, pce, aged white. Can be use on US + Mex. Strat from 1954-present.

**005-4521-049**

72 Telecaster® Custom Knobs (Set of 4), black. Plastic control knobs (two «volume», two «tone») for use on Mexico-made '72 Telecaster Custom.

**009-4040-049**

Pure Vintage '52 Telecaster® Knurled Knobs, 2pces, chrome. Used on early '50s Telecaster + Esquire®. Fits most vintage & modern Tele.

**009-4057-049**

Pure Vintage '58 Telecaster® Knurled Knobs, 2pces, chrome. Used on the American Vintage '58 Telecaster®. Fits most vintage & modern Tele.

**009-5799-049**

Pure Vintage '60s Telecaster® Knurled Knobs, 2pces, chrome. Used on early American Vintage '64 Telecaster®. Fits most vintage & modern Tele.

**099-1366-000**

Telecaster®/P-Bass® Knurled Knobs, 2pces, chrome. For most U.S.- and Mexico-made Telecaster and Precision Bass models (1951-present).

**099-2056-000**

Telecaster®/P-Bass® Dome Knobs, 2pces, chrome. For most U.S.- and Mexico-made Telecaster and Precision Bass models (1951-present).

**099-2056-200**

Telecaster®/P-Bass® Dome Knobs, 2pces, gold. For most U.S.- & Mexico-made Telecaster and Precision Bass models (1951-present).

**099-1370-000**

Jazz Bass Knobs, Black (2 Large, 1 Small), 3pces, black. For most U.S.- and Mexico-made Jazz Bass models (1964-present).

**099-2085-000**

Pure Vintage '60s Jazz Bass Knobs, 3pces, black. Used on early '60s Jazz Bass® guitars. Fits most vintage and modern Jazz Bass guitars.

**099-2086-000**

Pure Vintage 1965 Jazzmaster® «Witch Hat» Knobs, 2pces, white. Used on 1965 Jazzmaster® guitar. Fits most vintage & modern Jazzmaster.

Switches



001-9455-049

Pure Vintage 1965 Jaguar® Skirted Knobs, 2pcs, black. Can be use on US + Mex. Strat from 1954-present.



099-1367-000

5-Position Stratocaster® Pickup Selector Switch. White + black switch tips included. For most American, Standard, Special & Deluxe Strat.



003-8929-049

Pure Vintage 5-Position Pickup Selector Switch. Vintage-style, for use on most vintage & contemporary Stratocaster® models.



099-2041-000

3-Position Vintage Stratocaster®-Telecaster Pickup Selector Switch. Strat & Tele switch tip included. For a variety of Telecaster and Stratocaster models.



003-8993-049

Pure Vintage 3-Position Pickup Selector Switch. Vintage-style three-position Stratocaster or Telecaster pickup selector switch.



099-2250-000

4-Position Telecaster® Custom Pickup Selector Switch. Black «barrel» tip for a Telecaster. Used on many Custom Shop instruments.



099-2251-000

5-Position Strat®-Tele® Super Switch. White tip for a Strat, black «barrel» tip for a Tele. Used on U.S.-made Fat Strat & Double Fat Strat and on Nashville Telecaster models.



005-4063-049

Toronto 3-Way Toggle Switch. Used on Telesonic, Strat-o-Sonic, and Toronto (US) models manufactured from 1998-2007.



005-3694-049

Pure Vintage 3-Position Pickup Selector Toggle Switch. Used for pickup selection on vintage and modern Jaguar® + Jazzmaster®.

Switch Tips



099-4939-000

Stratocaster® Switch Tips, black. Set of two pickup switch tips for use on most U.S.- and Mexico-made Stratocaster® models.



099-4940-000

Stratocaster® Switch Tips, white. Set of two pickup switch tips for use on most U.S.- and Mexico-made Stratocaster® models.



099-4938-000

Stratocaster® Switch Tips, aged white. Set of two pickup switch tips for use on most U.S.- and Mexico-made Stratocaster® models.



009-3596-049

Pure Vintage Stratocaster® Switch Tip, vintage white. One plastic vintage white switch tip, used on American Vintage '59 and '65 Stratocaster®.



099-4936-000

Telecaster® Barrel-Style Switch Tips, black. Set of two plastic «barrel» switch tips. For most U.S.- + Mexico-made Telecaster (1952-present)



009-3602-049

Pure Vintage Original Telecaster® Switch Tip, piece, black. Used on early '50s Telecaster® and Esquire®. Fits most vintage & modern Tele.



099-4937-000

Pure Vintage Telecaster® Top-Hat Style Switch Tips, 2pcs, black. Plastic top-hat-style switch tips. Fits most vintage & modern Telecaster.

Capacitors



002-4832-049

Capacitor - MPF RDL .022uf @ 250v 10%, 12pcs. Replacement capacitors used in tone potentiometer circuitry for most Fender instruments. Metalized polyester film radial design.



Output Jacks



XUMSW

Nut for Switchcraft Output Jack, Nut, nickel.
Nut for Switchcraft jacks J0018/
J0019 and for CTS Pots.

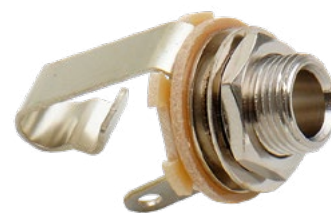

J0018

Switchcraft Mono Jack. The standard in "open" jacks! Thick contacts, yellow fibre isolation nuts, 6.3mm, US thread.

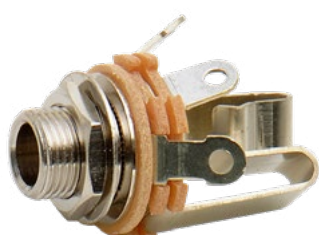

J0019

Switchcraft Stereo Jack. The standard in "open" jacks! Thick contacts, yellow fibre isolation nuts, 6.3mm, US thread.



J0020

Tube Jack, stereo, nickel. 6.3mm for side mounting, hole of 2mm, including washer & nut. Contacts fastened in fibre nuts!



J0026

Deluxe Mono Output Jack. 6.3mm. Fat German heavy-duty silver platinized contacts, thick black fibre isolation nuts. Metric thread.



J0027

Deluxe Stereo Output Jack. 6.3mm. Fat German heavy-duty silver platinized contacts, thick black fibre isolation nuts. Metric thread.



J0027G

Deluxe Stereo Output Jack, gold. 6.3mm. Fat German heavy-duty silver platinized contacts, thick black fibre isolation nuts. Metric thread.



J002B

Tube Jack, stereo, black chrome. 6.3mm for side mounting, hole of 2mm, including washer & nut. Contacts fastened in fibre nuts!



J002G

Tube Jack, stereo, gold. 6.3mm for side mounting, hole of 2mm, including washer & nut. Contacts fastened in fibre nuts!



JA00B

Acoustic Tube Jack, black. 6.3mm. Fibre isolation. The nut fastens the jack & serves as a strap pin, metal cap to protect the solder contacts.



JA00C

Acoustic Tube Jack, nickel. 6.3mm. Fibre isolation. The nut fastens the jack & serves as a strap pin, metal cap to protect the solder contacts.



JA00G

Acoustic Tube Jack, gold. 6.3mm. Fibre isolation. The nut fastens the jack & serves as a strap pin, metal cap to protect the solder contacts.

Jack Plates



J000B

Oval Jack Plate, 2-hole, metal, black.



J000C

Oval Jack Plate, 2-hole, chrome.



J000N
Oval Jack Plate, 2-hole, nickel.



J000G
Oval Jack Plate, 2-hole, gold.



J300C
3-hole jack plate, chrome. For the installation of a standard guitar output jack (J0018, J0019) into the end block of an acoustic guitar.



JLP0B
4-hole jack plate for Les Paul, radiussed, metal, black. For Les Paul, Tele etc.



JLP0C
4-hole jack plate for Les Paul, radiussed, chrome. For Les Paul, Tele etc.



JLP0G
4-hole jack plate for Les Paul, radiussed, gold. For Les Paul, Tele etc.



JLPPB
Les Paul Jack Plate, black. Square, 4-hole, plastic.



JLPPK
Les Paul Jack Plate, cream. Square, 4-hole, plastic.



JSC1B
Deluxe Jack Plate for Strat, black. Finest vintage shaping!



JSC1C
Deluxe Jack Plate for Strat, chrome. Finest vintage shaping!



JSC1G
Deluxe Jack Plate for Strat, gold. Finest vintage shaping!



JTC
Vintage Jack Cup for Tele, chrome. Use our ingenious spreading tool for the mounting clamp - WSJTC!



JTS1B
Deluxe Jack Cup for Tele, black. Held in place by 2 angled screws screwed into the wood. Metric jack thread.



JTS1C
Deluxe Jack Cup for Tele, chrome. Held in place by 2 angled screws screwed into the wood. Metric jack thread.



JTS1G
Deluxe Jack Cup for Tele, gold. Held in place by 2 angled screws screwed into the wood. Metric jack thread.



Fender-style switches & knobs

EL02M
Mini Toggle Switch, on/on, chrome. Compact toggle switch with 2 x 3 solder pins. Usable as a pickup on/off switch, a coil tap switch or similar.

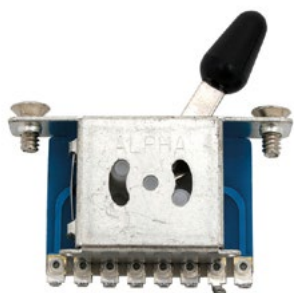
**EL3PL**

Mini Toggle Switch, 3-way. 2 layers, circuit board construction.

**EL5PL**

Economy 5-Way Switch, 5-way. 2 layers, circuit board construction.

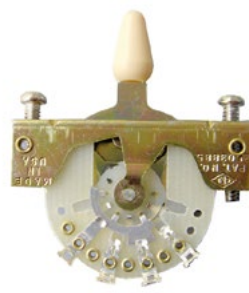
**US003**

3-Way Switch for Strat/Tele. The solid classic! As used on countless older Fender guitars. 2 switching layers with 1+3 contacts each.

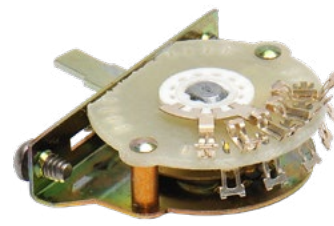
**US004**

4-Way Switch for Strat/Tele. Conventional spring-contact constr. The 4 position may be used in a Telecaster for additionally connecting both pickups in series.

**US2X3**

«Double Wafer» 3-Way Switch, 4 x 3-Way. Switches simultaneously on 4 layers, so you have two times the contacts of a normal switch.

**US2X5**

«Double Wafer» 5-Way Switch, 4 x 5-Way. Switches simultaneously on 4 layers, so you have two times the contacts of a normal switch.

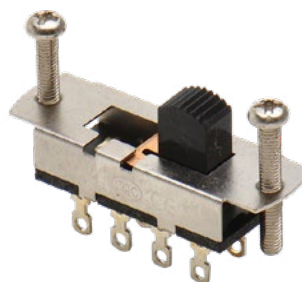
**WDE15**

Switch for Mustang. 3 positions, 8 pins. Window for slider: 20 x 6mm. Distance of screws middle to middle: 35,5mm.

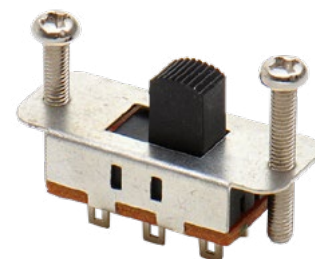
**WDE16**

Switch for Jaguar + Jazzmaster. 2 positions, 6 pins

**EKT3B**

Switch Tip for Tele, black. Wide slot, for US switches.

**EKT3C**

Switch Tip for Tele, chrome. Wide slot, for US switches.

**ELK1B**

Tip for «F-style» Switch, black. Narrow slot, fits many Japanese switches.

**ELK1W**

Tip for «F-style» Switch, white. Narrow slot, fits many Japanese switches.

**ELK1K**

Tip for «F-style» Switch, cream. Narrow slot, fits many Japanese switches.

**ELK3B**

Tip for «F-style» Switch, black. Wide slot, for «US» switches.

**ELK3W**

Tip for «F-style» Switch, white. Wide slot, for «US» switches.

**ELK3K**

Tip for «F-style» Switch, cream. Wide slot, for «US» switches.



ELT1B

Knob for Tele switch, black. Narrow slot, for Japanese switches.



ELT1W

Knob for Tele switch, white. Narrow slot, for Japanese switches.



ELT1K

Knob for Tele switch, cream. Narrow slot, for Japanese switches.



KBGLC

Lever Switch Knob, for toggle switch, chrome. Brass knob for Gibson-style toggle switches. 12mmØ x 14.5mm, M4 inside thread.



KBGLN

Lever Switch Knob, for toggle switch, nickel. Brass knob for Gibson-style toggle switches. 12mmØ x 14.5mm, M4 inside thread.



KBGLG

Lever Switch Knob, for toggle switch, gold. Brass knob for Gibson-style toggle switches. 12mmØ x 14.5mm, M4 inside thread.



KBGSC

Lever Switch Knob, for lever switch, chrome. Brass knob for Fender-Style pickup switches. 12mmØ x 14.5mm, hole 4.9mm, M4 hex screw.



KBGSN

Lever Switch Knob, for lever switch, nickel. Brass knob for Fender-Style pickup switches. 12mmØ x 14.5mm, hole 4.9mm, M4 hex screw.



KBGSG

Lever Switch Knob, for lever switch, gold. Brass knob for Fender-Style pickup switches. 12mmØ x 14.5mm, hole 4.9mm, M4 hex screw.



**Toggle Switches,
Mini Switches,
Tips**

EL002

Deluxe Toggle Switch, nickel. Gold-Contacts!



EL005

Rotary Switch, 5 positions, 4 switching layers. Measures without shaft: 30 x 34 x 37.5 mm (H x W x D). Knurled Shaft. Drill hole: 9mm.



EL011

Mini Switch with flat lever, on/on, black. 6 pins, on/on, for coil splitting, out of phase, serial/parallel wiring and the likes.



EL012

Mini Switch with flat lever, 2x on/off/on, black. 6 pins, center position OFF. For "on/off", splitting, out of phase, in series / parallel.



EL013

Mini Switch with flat lever, 2x on/on/on, black. 6 pins, can be used as a selector switch for 2 pickups.



EL02C

Economy Toggle Switch, nickel.



EL02G

Economy Toggle Switch, gold. Visible areas completely gold plated.

**EL04D**

Rotary Switch, 4 pos., 3 switching layers. Used on Dues. «Gran Royale», «Gran Majesto» & «Paloma». Measures without shaft: 18 x 31 x 25 mm. Solid shaft 6mm. Drill hole: 9mm.

**EL11C**

Mini Switch with round lever, 2x on/on, nickel. 6 Pins.

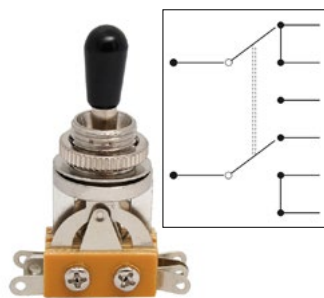
**EL33C**

Double Toggle Switch, nickel. With additional contacts for «special occasions» (see schematics).

**WDE6**

Toggle Switch «SG», angled. Horizontal switching contacts. For guitars with a shallow body (e.g. Gibson SG).

**EL2PB**

Treble/Rhythm Plate for LesPaul, black. For toggle switches.

**EL2PK**

Treble/Rhythm Plate for LesPaul, cream. For toggle switches.

**ELK2B**

Knob for Toggle Switch, black.

**ELK2K**

Knob for Toggle Switch, cream.

**ELK2S**

Knob for Toggle Switch, vintage amber.

**ELK5B**

Knob for korean Toggle Switch, black.

**ELK5K**

Knob for korean Toggle Switch, cream.

**ELN2G**

Toggle Nut, 12mm, gold.

**KU04B**

«Radiomatic-Line» **Lead/Rhythm Disc**, black/gold. For Les Paul toggle switches. Transparent plastic with a black/gold imprint on the bottom side.

**KU04N**

«Radiomatic-Line» **Treble/Rhythm Disc**, nickel. For Les Paul toggle switches. Nickel coloured plastic without imprint.

**KU05N**

«Radiomatic-Line» **Scale Disc for Pots**, nickel. Matches the Treble/Rhythm plate KU04N. Nickel coloured plastic without imprint.

**KU06B**

«Radiomatic-Line» **Strip for F-Switches**, black/gold. Decoration for F-style lever switch. Matches the pot scale KU05B.



KU06N
«Radiomatic-Line» Strip for F-Switches, nickel. Decoration for F-style lever switch. Matches the pot scale KU05B.



SR112
Lock Washer for 12mm, 20pcs.



Standard Pots

CTS250
Original CTS Push/Pull Pot, 250K log. Made in USA. Threads 9x10mmØ, housing 24mmØ, knurled shaft.



CTS250P
Original CTS Premium Push/Pull Pot, 250K log. Made in USA. Threads 9,35 x 9,35mmØ, housing 24mmØ, slotted ripple shaft.



CTS500
Original CTS Pot, 500K log. Made in USA. Threads 9x10mmØ, housing 24mmØ, knurled shaft.



CTS500P
Original CTS Premium Pot, 500K log. Made in USA. Threads 9,35 x 9,35mmØ, housing 24mmØ, slotted ripple shaft.



E100M
Mini Pot, heavy duty, 8mm, 100K log. Small size. Threads 10x8mmØ, housing 16.5mmØ, knurled shaft.



E250L
Deluxe Pot, heavy duty, 8mm, 250K lin. Made in Japan. Threads 10x8mmØ, housing 24mmØ, knurled shafts. Smooth-running, tin plated housing for easy soldering!



E250M
Mini Pot, heavy duty, 8mm, 250K log. Small size. Threads 10x8mmØ, housing 16.5mmØ, knurled shaft.



E500L
Deluxe Pot, heavy duty, 8mm, 500K lin. Made in Japan. Threads 10x8mmØ, housing 24mmØ, knurled shafts. Smooth-running, tin plated housing for easy soldering!



E500M
Mini Pot, heavy duty, 8mm, 500K log. Small size. Threads 10x8mmØ, housing 16.5mmØ, knurled shaft.



EL1MG
Mini Pot, 1M log. Small size. Threads 10x8mmØ, housing 16.5mmØ, knurled shaft.



EL250
Deluxe Pot, heavy duty, 8mm, 250K log. Threads 10x8mmØ, housing 24mmØ, knurled shafts. Smooth-running, tin plated housing for easy soldering!



EL25K
Mini Pot, heavy duty, 8mm, 25K log. Small size. Threads 10x8mmØ, housing 16.5mmØ, knurled shaft.



EL500
Deluxe Pot, heavy duty, 8mm, 500K log. Threads 10x8mmØ, housing 24mmØ, knurled shafts. Smooth-running, tin plated housing for easy soldering!



EL500LH
Original CTS Pot, 500K log, lefthand. Made in USA. Threads 9x10mmØ, housing 24mmØ, knurled shaft.

**EL56J**

Mini-Pot for Archtop Guitar, 250K log. Threads 6.5x8mmØ, housing 16.5mmØ, knurled shaft. extra small size. For mounting on «free-floating» pickguards of archtop guitars.

**US250**

CTS-Type Pot, 250K log. Brass threads 9x10mmØ, housing 24mmØ, knurled shaft. Tin-plated housings for easy soldering.

**US500**

CTS-Type Pot, 500K log. Brass threads 9x10mmØ, housing 24mmØ, knurled shaft. Tin-plated housings for easy soldering.

**US5XL**

CTS-Type Pot, extra long, 500K log. Brass threads 20x10mmØ, housing 24mmØ, knurled shaft. Tin-plated housings. For Les Pauls or other guitar with thick woodencp top.

**CP500**

Double Pot, 2x500K log. Concentric Shafts! Two separately adjustable pots in one housing. Threads 6.5x10mmØ, housing 24mmØ, knurled shaft. Incl. Knobs.

**E250P**

Mini Push/Pull Pot, 250K log Push/Pull. Small size. Threads 10x8mmØ, housing 16.5mmØ, knurled shaft. Switch on/on, double-pole double-throw, is activated by pulling.

**E250PP**

Mini Push/Push Pot, 250K log. Small size. Threads 10x9mmØ, housing 16.5mmØ, knurled shaft. Switch on/on, double-pole double-throw, is activated by repeated pushing.

**E500LP**

Mini Push/Pull Pot, extra long, 500K log. Small size. Threads 18x10mmØ, housing 16.5mmØ, knurled shaft. On/On Switch. For Les Paul and other guitars with a thick top.

**E500P**

Mini Push/Pull Pot, 500K log. Small size. Threads 10x8mmØ, housing 16.5mmØ, knurled shaft. Switch on/on, double-pole double-throw, is activated by pulling.

**E500PP**

Push/Push Pot, 500K lin Push/Push. Small size. Threads 10x9mmØ, housing 16.5mmØ, knurled shaft. Switch on/on, double-pole double-throw, is activated by repeated pushing.

**ELPAN250**

True Panorama Pot, 2x250K. Double pot with central raster. Thread 10x7mmØ, housing 17mmØ, straight shaft. For crossfading two pickups.

**BPF9V**

Snap In battery case for 9 Volt, black. Suitable for electric, acoustic & bass guitars. Holds a 9V block securely in place.

**EL10N**

Capacitor for Tone Control, 10nF, 10pcs. 10, 15, 22nF for guitar/22, 33r, 47nF for bass. The higher value, the duller sound. Choose smaller values for louder pickups like humbuckers.

**EL15F**

Capacitor for Tone Control, 15nF, 10pcs. 10, 15, 22nF for guitar/22, 33r, 47nF for bass. The higher value, the duller sound. Choose smaller values for louder pickups like humbuckers.

**EL22N**

Capacitor for Tone Control, 22nF, 10pcs. 10, 15, 22nF for guitar/22, 33r, 47nF for bass. The higher value, the duller sound. Choose smaller values for louder pickups like humbuckers.

**EL33N**

Capacitor for Tone Control, 33nF, 10pcs. 10, 15, 22nF for guitar/22, 33r, 47nF for bass. The higher value, the duller sound. Choose smaller values for louder pickups like humbuckers.



EL47N

Capacitor for Tone Control, 47nF, 10pcs. 10, 15, 22nF for guitar/22, 33r, 47nF for bass. The higher value, the duller sound. Choose smaller values for louder pickups like humbuckers.



EL220

Volume Capacitor 220 pF, 10 pcs. For guitar and bass. Soldered between the center & the input of the pot., it prevents the loss of treble when turning down the potentiometer.



EL223

"Oil Caps" Capacitor, 22nF, 10 pcs. Classic capacitor type, preferably used for volume control of electric guitars. Lowest tolerances, great look!



EL473

"Oil Caps" Capacitor, 47nF, 10 pcs. Classic 47nF capacitor type, e.g. for tone control in basses. Lowest tolerances, great look!



EL855

The Activator Preamp PA1. Increases the pickup volume (+15dB) without altering its sound! Adjustment by trim pot!



EL900

Professional Shielding Kit. A great set of different self adhesive Copper foils (sheet & stripes), some wire and solder to shield Pickguards, Pickups and electric cavities.



EL902

Copper Tape, adhesive, 12.7mm. 33m roll.



EL906

Copper Tape, adhesive, 6.4mm. 33m roll.



EL903

Aluminium Shielding Foil, adhesive. 1 sheet, 16x20cm



ELF2P

Foot Switch for pedal. 2-pole, 4 pins. Made in Italy, very good quality!



ELF4P

Foot Switch for pedal. 4-pole, 8 pins. Heavy-duty, for converting effect pedals to true bypass. Made in Italy, very good quality!



KB00B

Dome Speed Knob/marked, black. Allen Screw. Features handy knurling & position marker. Fits 6mm pot shafts. 18.3mmØ, height: 18mm

Metal knobs



KB00C

Dome Speed Knob/marked, chrome. Allen Screw. Features handy knurling & position marker. Fits 6mm pot shafts. 18.3mmØ, height: 18mm



KB00N

Dome Speed Knob/marked, nickel. Allen Screw. Features handy knurling & position marker. Fits 6mm pot shafts. 18.3mmØ, height: 18mm



KB00G

Dome Speed Knob/marked, gold. Allen Screw. Features handy knurling & position marker. Fits 6mm pot shafts. 18.3mmØ, height: 18mm



KB02C

Dome Speed Knob/unmarked, chrome. Faithful reproduction of the original Dome Speed Knob without any position markers. Fits 6mm pot shafts. 18.3mmØ, height: 18mm

**KB02G**

Dome Speed Knob/unmarked, gold. Faithful reproduction of the original Dome Speed Knob without any position markers. Fits 6mm pot shafts. 18.3mmØ, height: 18mm

**KB50B**

DIAMOND Knob, black. Intended for use with Goeldo own button inlays or your custom inlays (e.g. in leather, wood...). 18mmØ, inlay 15mmØ

**KB50C**

DIAMOND Knob, chrome. Intended for use with Goeldo own button inlays or your custom inlays (e.g. in leather, wood...). 18mmØ, inlay 15mmØ

**KB50N**

DIAMOND Knob, nickel. Intended for use with Goeldo own button inlays or your custom inlays (e.g. in leather, wood...). 18mmØ, inlay 15mmØ

**KB50G**

DIAMOND Knob, gold. Intended for use with Goeldo own button inlays or your custom inlays (e.g. in leather, wood...). 18mmØ, inlay 15mmØ

**KB55A**

Inlay for DIAMOND Knob, amber pearlloid. The inlay is simply glued into the button from above with a drop of super glue - done.

**KB55B**

Inlay for DIAMOND Knob, black, «Dome». The inlay is simply glued into the button from above with a drop of super glue - done.

**KB55P**

Inlay for DIAMOND Knob, white pearlloid, «Dome». The inlay is simply glued into the button from above with a drop of super glue - done.

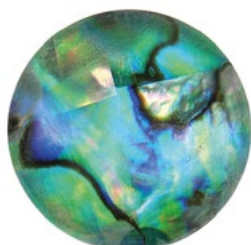
**KB5AB**

Inlay for DIAMOND Knob, abalone. The inlay is simply glued into the button from above with a drop of super glue - done.

**KBG18C**

Deluxe Metal Knob, small, chrome. High-grade brass knob for pots with plain 6mm shaft. M4 fastening screw. 18mmØ x 14.5mm.

**KBG18N**

Deluxe Metal Knob, small, nickel. High-grade brass knob for pots with plain 6mm shaft. M4 fastening screw. 18mmØ x 14.5mm.

**KBG18G**

Deluxe Metal Knob, small, gold. High-grade brass knob for pots with plain 6mm shaft. M4 fastening screw. 18mmØ x 14.5mm.

**KBG22C**

Deluxe Metal Knob, large, chrome. High-grade brass knob for pots with plain 6mm shaft. M4 fastening screw. 22mmØ x 15mm.

**KBG22N**

Deluxe Metal Knob, large, nickel. High-grade brass knob for pots with plain 6mm shaft. M4 fastening screw. 22mmØ x 15mm.

**KBG22G**

Deluxe Metal Knob, large, gold. High-grade brass knob for pots with plain 6mm shaft. M4 fastening screw. 22mmØ x 15mm.

**KBGTC**

Deluxe Metal Knob, high, chrome. High-grade brass knob for pots with plain 6mm shaft. M4 fastening screw. 22mmØ x 18.5mm.



KBGTN

Deluxe Metal Knob, high, nickel.
High-grade brass knob for pots with plain 6mm shaft. M4 fastening screw. 22mmØ x 18.5mm.



KBGTG

Deluxe Metal Knob, high, gold.
High-grade brass knob for pots with plain 6mm shaft. M4 fastening screw. 22mmØ x 18.5mm.



KBRUN

Celtic Knob, chrome. Dome Speed style knob with rune decoration. Set-Screw for attachment.



KBS1A

Metal Knob for Strat, aluminium.



KBT1C

Knob for Tele, chrome. Original look TL-Type Potknob for press-fit onto knurled pot-shafts. Plastic insert for press fit, no set-screw.



KBTLC

Knob for Tele, chrome. Reproduction of the original TL-Type Potknob. Large knurling and flat top. Fixes via set allen screw on solid-shaft pots.



KSKUL

Skull Knob, chrome plated metal. For the darker crowd. For 6mm pot-shafts, fixes via set allen screw.



KBCHC

«Chickenhead» Knob, chrome. Classic Chickenhead Knob made from chrome plated Aluminium. Fixing by set allen screw.



KB10B

Amp Knob, black. Featuring handy knurling, set screw and scale. For 6mm pot shafts.



KB15B

Speed Knob for Gibson, black. Plexi, cylindrical, for US-size knurled shafts (CTS etc.). Faithful reproduction of the original Speed Knob (aka «Hatbox») for Gibson.



KB15G

Speed Knob for Gibson, gold. Plexi, cylindrical, for US-size knurled shafts (CTS etc.). Faithful reproduction of the original Speed Knob (aka «Hatbox») for Gibson.



KB15T

Speed Knob «Skull 13», black. For coarsely knurled shafts (Japan etc.). Semi-transparent plastic button in a fancy skull design.



KB20B

Bell-Knob for Gibson, black. For US-size knurled shafts (CTS etc.). Faithful reproduction of the original Bell-Knob for Gibson.



KB20G

Bell-Knob for Gibson, gold. For US-size knurled shafts (CTS etc.). Faithful reproduction of the original Bell-Knob for Gibson.



KB21B

Bell-Knob, Plexi, black. For US-size knurled shafts (CTS etc.). Faithful reproduction of the original Bell-Knob for Gibson.



KB21G

Bell-Knob, Plexi, gold. For US-size knurled shafts (CTS etc.). Faithful reproduction of the original Bell-Knob for Gibson.

**KB5JB**

Speed Knob, Plexi, black. For coarsely knurled shafts (Japan etc.). Faithful reproduction of the original Speed Knob (aka «Hatbox») for Gibson.

**KB5JG**

Speed Knob, Plexi, gold. For coarsely knurled shafts (Japan etc.). Faithful reproduction of the original Speed Knob (aka «Hatbox») for Gibson.

**KB6TG**

Universal Knob, black/gold. Tone. Simple plastic knob for press-fit on knurled shaft pots. Ideal for amps or unique custom made instruments.

**KB6VG**

Universal Knob, black/gold. Volume. Simple plastic knob for press-fit on knurled shaft pots. Ideal for amps or unique custom made instruments.

**KB16B**

«Sci-Fi Pointer» Knob, black. Plastic, for knurled shaft. The classic Chickenhead Knob made from thick black plastic.

**KBCLB**

«Chickenhead»-Knob, Plastic, large, black. Length: ca. 31mm, height: ca. 17mm, with screw. For 6.3mm shafts. The ultimate Style-Update for classic amps.

**KBCLA**

«Chickenhead»-Knob, Plastic, large, aged white. Length: ca. 31mm, height: ca. 17mm, with screw. For 6.3mm shafts. The ultimate Style-Update for classic amps.

**KBCLW**

«Chickenhead»-Knob, Plastic, large, white. Length: ca. 31mm, height: ca. 17mm, with screw. For 6.3mm shafts. The ultimate Style-Update for classic amps.

**KBCSB**

«Chickenhead»-Knob, Plastic, small, black. Length: ca. 23mm, height: ca. 13.5mm, to press-fit. The ultimate Style-Update for classic amps.

**KBCSA**

«Chickenhead»-Knob, Plastic, small, aged white. Length: ca. 23mm, height: ca. 13.5mm, to press-fit. The ultimate Style-Update for classic amps.

**KBDOT**

Marker, 12 pcs, metal marker for pots. For knobs up to Ø 20mm. Place between washer and nut of the pot.

**KBE1B**

«Gripknob» for effect pedals, black, with screw. Small handy plastic knob. With an Allen screw for solid shaft pots.

**KBE2B**

«Gripknob» for effect pedals, black, without screw. Small handy plastic knob. For slotted shaft.

**KBH0G**

«Knurlknob», plastic, cream. Ø20-19mm (slightly conical), height 12mm, for plain shafts 6-6.5mm. With Allen screw. For Instruments, Amps or Effectpedals with solid-shaft pots.

**KBH0G**

«Hat-Knob», Plexi, hat-shape, gold. For US-size knurled shafts (CTS etc.). Faithful reproduction of the original Hat-Knob for Gibson.

**KBHVB**

«Hat-Knob», Plexi, hat-shape, black. For US-size knurled shafts (CTS etc.). Faithful reproduction of the original Hat-Knob for Gibson.

**KBHVG**

«Hat-Knob», Plexi, hat-shape, vintage amber. For US-size knurled shafts (CTS etc.). Faithful reproduction of the original Hat-Knob for Gibson.

**KBHJG**

«Hat-Knob», Plexi, hat-shape, gold. For coarsely knurled shafts (Japan etc.). Faithful reproduction of the original Hat-Knob for Gibson.

**KBHJB**

«Hat-Knob», Plexi, hat-shape, black. For coarsely knurled shafts (Japan etc.). Faithful reproduction of the original Hat-Knob for Gibson.

**KBHJA**

«Hat-Knob», Plexi, hat-shape, vintage amber. For coarsely knurled shafts (Japan etc.). Faithful reproduction of the original Hat-Knob for Gibson.

**KBSTB**

«Tone» Knob for Strat, black. Vintage style with large lettering! For coarsely knurled shafts (Japan etc.). Faithful reproduction of the vintage potknobs for Strat.

**KBSTK**

«Tone» Knob for Strat, cream. Vintage style with large lettering! For coarsely knurled shafts (Japan etc.). Faithful reproduction of the vintage potknobs for Strat.

**KBSTW**

«Tone» Knob for Strat, white. Vintage style with large lettering! For coarsely knurled shafts (Japan etc.). Faithful reproduction of the vintage potknobs for Strat.

**KBSTA**

«Tone» Knob for Strat, aged white. Vintage style with large lettering! For coarsely knurled shafts (Japan etc.). Faithful reproduction of the vintage potknobs for Strat.

**KBSVB**

«Volume» Knob for Strat, black. Vintage style with large lettering! For coarsely knurled shafts (Japan etc.). Faithful reproduction of the vintage potknobs for Strat.

**KBSVK**

«Volume» Knob for Strat, cream. Vintage style with large lettering! For coarsely knurled shafts (Japan etc.). Faithful reproduction of the vintage potknobs for Strat.

**KBSVW**

«Volume» Knob for Strat, white. Vintage style with large lettering! For coarsely knurled shafts (Japan etc.). Faithful reproduction of the vintage potknobs for Strat.

**KBSVA**

«Volume» Knob for Strat, aged white. Vintage style with large lettering! For coarsely knurled shafts (Japan etc.). Faithful reproduction of the vintage potknobs for Strat.

**KSGTB**

Bell-Knob, Tone, black. For coarsely knurled shafts (Japan etc.). Faithful reproduction of the original Bell-Knob for Gibson.

**KSGVB**

Bell-Knob, Volume, black. For coarsely knurled shafts (Japan etc.). Faithful reproduction of the original Bell-Knob for Gibson.

**KBJBL**

Knob for Jazz Bass, black, big. With position markings. Reproduction of the classic potknob for Jazz-Bass models.

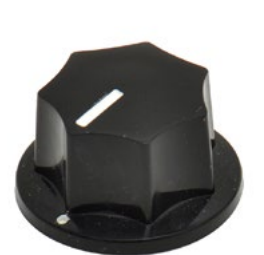
**KBJBS**

Knob for Jazz Bass, black, small. With position markings. Reproduction of the classic potknob for Jazz-Bass models.

GOTOH®

Jack Plates

**GRSJP**

Relic Jack Plate for Strat, aged chrome. Incl. screws. True to original dimensions like Fender® Stratocaster and its copies and variants.

Metal knobs

**GRKBD**

Relic Knob Dome, aged chrome. Control knob for Telecaster. Round top. Diameter: 19mm - Height: 18,4mm - Diameter shaft hole: 6mm Secured by slotted screw.

Schaller

Megaswitches

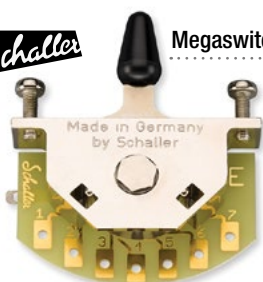
**SC-15310002**

Megaswitch E, 5-way. Extremely rugged metal housings and super-solid moving parts with gold-plated conducting paths. For perfect sound, functionality & a long service life.

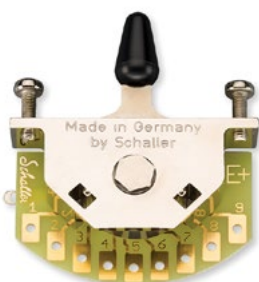
**SC-15310005**

Megaswitch E+, 5-way. Extremely rugged metal housings and super-solid moving parts with gold-plated conducting paths. For perfect sound, functionality & a long service life.

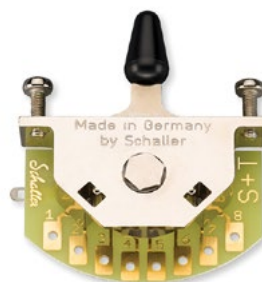
**SC-15310003**

Megaswitch S, 5-way. Extremely rugged metal housings and super-solid moving parts with gold-plated conducting paths. For perfect sound, functionality & a long service life.

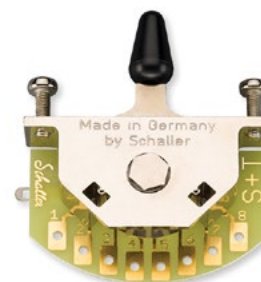
**SC-15310013**

Megaswitch S, 3-way. Extremely rugged metal housings and super-solid moving parts with gold-plated conducting paths. For perfect sound, functionality & a long service life.

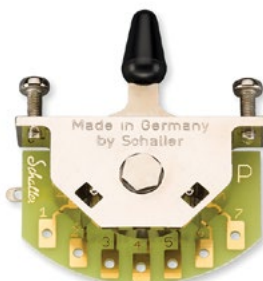
**SC-15310004**

Megaswitch P, 5-way. Extremely rugged metal housings and super-solid moving parts with gold-plated conducting paths. For perfect sound, functionality & a long service life.

**SC-15310006**

Megaswitch M, 5-way. Extremely rugged metal housings and super-solid moving parts with gold-plated conducting paths. For perfect sound, functionality & a long service life.

**SC-15330002**

Megaswitch E Rotary, 5-way. Extremely rugged metal housings & super-solid moving parts with gold-plated conducting paths. For perfect sound, functionality & a long service life.

**SC-15330003**

Megaswitch S+T Rotary, 5-way. Extremely rugged metal housings & super-solid moving parts with gold-plated conducting paths. For perfect sound, functionality & a long service life.

Strat knob

**SC-15010100**

Strat Knob, nickel, 3 pcs.. Feature a grub screw recessed into the side, allowing them to be neatly & securely fastened to the pot shaft. 6mm thread.

**SC-15010200**

Strat Knob, chrome, 3 pcs.. Feature a grub screw recessed into the side, allowing them to be neatly & securely fastened to the pot shaft. 6mm thread.

**SC-15010400**

Strat Knob, black chrome, 3 pcs.. Feature a grub screw recessed into the side, allowing them to be neatly & securely fastened to the pot shaft. 6mm thread.

**SC-15010500**

Strat Knob, gold, 3 pcs.. Feature a grub screw recessed into the side, allowing them to be neatly & securely fastened to the pot shaft. 6mm thread.

Dome knob



SC-15010600

Strat Knob, ruthenium, 3 pcs.. Feature a grub screw recessed into the side, allowing them to be neatly & securely fastened to the pot shaft. 6 mm thread.



SC-15020100

Dome knob, nickel, 2 pcs.. Feature a grub screw recessed into the side, allowing them to be neatly & securely fastened to the pot shaft. 6 mm thread.



SC-15020200

Dome Knob, chrome, 2 pcs.. Feature a grub screw recessed into the side, allowing them to be neatly & securely fastened to the pot shaft. 6 mm thread.



SC-15020400

Dome Knob, black chrome, 2 pcs.. Feature a grub screw recessed into the side, allowing them to be neatly & securely fastened to the pot shaft. 6 mm thread.

Speed knob



SC-15020500

Dome knob, gold, 2 pcs.. Feature a grub screw recessed into the side, allowing them to be neatly & securely fastened to the pot shaft. 6 mm thread.



SC-15020600

Dome Knob, ruthenium, 2 pcs.. Feature a grub screw recessed into the side, allowing them to be neatly & securely fastened to the pot shaft. 6 mm thread.



SC-15030100

Speed knob, nickel, 2 pcs.. Feature a grub screw recessed into the side, allowing them to be neatly & securely fastened to the pot shaft. 6 mm thread.



SC-15030200

Speed knob, chrome, 2 pcs.. Feature a grub screw recessed into the side, allowing them to be neatly & securely fastened to the pot shaft. 6 mm thread.

Toggle switch knob



SC-15030400

Speed knob, black chrome, 2 pcs.. Feature a grub screw recessed into the side, allowing them to be neatly & securely fastened to the pot shaft. 6 mm thread.



SC-15030500

Speed knob, gold, 2 pcs.. Feature a grub screw recessed into the side, allowing them to be neatly & securely fastened to the pot shaft. 6 mm thread.



SC-15030600

Speed knob, ruthenium, 2 pcs.. Feature a grub screw recessed into the side, allowing them to be neatly & securely fastened to the pot shaft. 6 mm thread.



SC-15210100

Toggle switch knob, nickel, pc.. Feature a grub screw recessed into the side. 4 mm thread.



SC-15210200

Toggle switch knob, chrome, pc.. Feature a grub screw recessed into the side. 4 mm thread.



SC-15210400

Toggle switch knob, black chrome, pc.. Feature a grub screw recessed into the side. 4 mm thread.



SC-15210500

Toggle switch knob, gold, pc.. Feature a grub screw recessed into the side. 4 mm thread.



SC-15210600

Toggle switch knob, ruthenium, pc.. Feature a grub screw recessed into the side. 4 mm thread.



Plates

	Chrome SC-15190200
	Black Chrome SC-15190400
	Gold SC-15190500
	Ruthenium SC-15190600

SC-15190100

Jack plate, nickel.
With 4 mounting screws.
Size: 35 x 35.4 x 3.3 mm



	Chrome SC-15200200
	Black Chrome SC-15200400
	Gold SC-15200500
	Ruthenium SC-15200600

SC-15200100

Toggle switch plate, nickel.
1 piece. Diameter: 33.7 mm



Pots



YJM-250

Yngwie Speed Pot – 250K. The perfect volume pot for the guitarist who wants fast, dynamic phrasing control.



YJM-500

Yngwie Speed Pot – 500K. The perfect volume pot for the guitarist who wants fast, dynamic phrasing control.



LB-1-250K

Liberator - 250k. Pickup swapping system that enables you to change pickups without a soldering iron. Replaces a standard 250k vol. pot.



LB-1-500K

Liberator - 500k. Pickup swapping system that enables you to change pickups without a soldering iron. Replaces a standard 500k vol. pot.

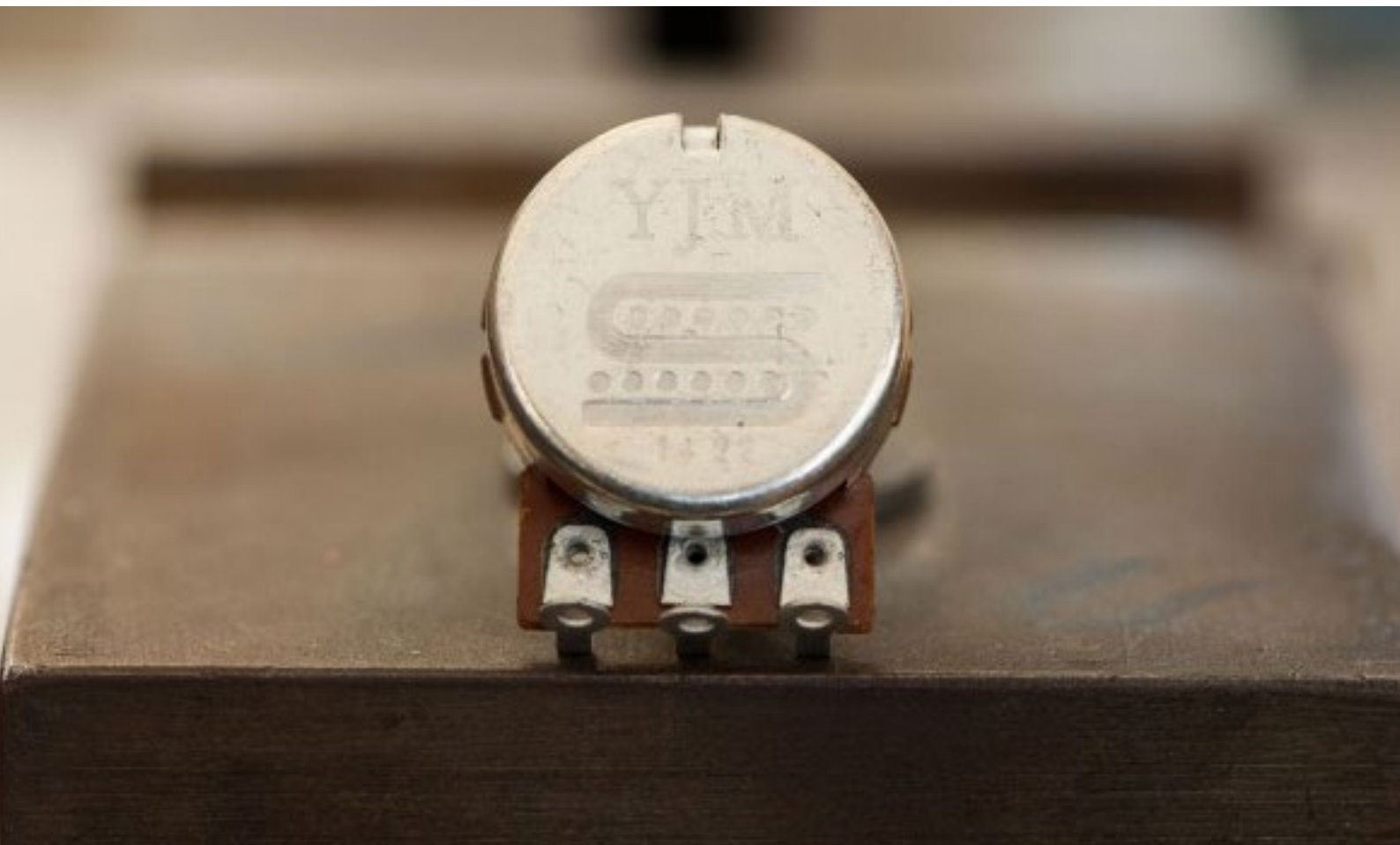

TUNING MACHINES





DUESENBERG

**MZD3DG**

Z-Tuners, Standard, gold, 3+3, 90°, 18:1 gear ratio. Comfortable and fast stringing - easy to maintain. For most Duesenberg guitars like Starplayer TV, Paloma or Caribou.

**MZD3DN**

Z-Tuners, Standard, nickel, 3+3, 90°, 18:1 gear ratio. Comfortable and fast stringing - easy to maintain. For most Duesenberg guitars like Starplayer TV, Paloma or Caribou.

**MZDVG**

Z-Tuners, open, 3-Step, 3+3, gold. Used on the Duesenberg Gran Majesto, Gran Royale and Julia Models.

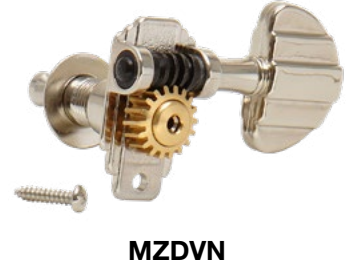
**MZDVN**

Z-Tuners, open, 3-Step, 3+3, nickel. Used on the Duesenberg Gran Majesto, Gran Royale and Julia Models.

**MZG33B**

Z-Tuners, Kidney, 3+3, black, 90°. With drilled tuner shaft which allows you to hide sharp string ends inside the tuner.

**MZG33C**

Z-Tuners, Kidney, 3+3, chrome, 90°. With drilled tuner shaft which allows you to hide sharp string ends inside the tuner.

**MZG33G**

Z-Tuners, Kidney, 3+3, gold, 90°. With drilled tuner shaft which allows you to hide sharp string ends inside the tuner.

**MZG33N**

Z-Tuners, Kidney, 3+3, nickel, 90°. With drilled tuner shaft which allows you to hide sharp string ends inside the tuner.

**MZK33N**

Z-Tuners Junior, 3+3, nickel. The Duesenberg standard tuner as used on most Duesenberg guitars. This version features Junior/Oval buttons.

**MZK6LB**

Z-Tuners Junior, 6 left, black. The Duesenberg standard tuner as used on most Duesenberg guitars. This version features Junior/Oval buttons.

**MZK6LG**

Z-Tuners Junior, 6 left, gold. The Duesenberg standard tuner as used on most Duesenberg guitars. This version features Junior/Oval buttons.

**MZK6LN**

Z-Tuners Junior, 6 left, nickel. The Duesenberg standard tuner as used on most Duesenberg guitars. This version features Junior/Oval buttons.

**MZK6RB**

Z-Tuners Junior, 6 right, black. The Duesenberg standard tuner as used on most Duesenberg guitars. This version features Junior/Oval buttons.

**MZKS33N**

Z-Tuners, Micro, 3+3, nickel. The Duesenberg Z-Tuners Micro are used on our 12-string models such as the DoubleCat, Caribou and Mando guitar.

**MZT33G**

Z-Tuners Tulip, 3+3, gold. The Duesenberg standard tuner as used on most Duesenberg guitars. This version features Tulip Buttons.

**MZT33N**

Z-Tuners Tulip, 3+3, nickel. The Duesenberg standard tuner as used on most Duesenberg guitars. This version features Tulip Buttons.



MDB22N

BASS Z-Tuners, 2+2, nickel, with an extra-long axle and the typical 3-step buttons



MDBLB

BASS Z-Tuners, 1 left, black, 90° latch. Comfortable stringing and service-friendly design! The strings are just put all through the tuner.



MDBLC

BASS Z-Tuners, 1 left, chrome, 90° latch. Comfortable stringing and service-friendly design! The strings are just put all through the tuner.



MDBLG

BASS Z-Tuners, 1 left, gold, 90° latch. Comfortable stringing and service-friendly design! The strings are just put all through the tuner.



MDBLN

BASS Z-Tuners, 1 left, nickel, 90° latch. Comfortable stringing and service-friendly design! The strings are just put all through the tuner.



MDBRB

BASS Z-Tuners, 1 right, black, 90° latch. Comfortable stringing and service-friendly design! The strings are just put all through the tuner.



MDBRC

BASS Z-Tuners, 1 right, chrome, 90° latch. Comfortable stringing and service-friendly design! The strings are just put all through the tuner.



MDBRG

BASS Z-Tuners, 1 right, gold, 90° latch. Comfortable stringing and service-friendly design! The strings are just put all through the tuner.



MDBRN

BASS Z-Tuners, 1 right, nickel, 90° latch. Comfortable stringing and service-friendly design! The strings are just put all through the tuner.

Fender



099-0802-100

ClassicGear™, 6 left, chrome. Used on American Performer guitars. Gear ratio of 18:1, bushings and washers included.



099-2074-000

Pure Vintage Guitar, 6 pcs, chrome. Fits most vintage and modern Stratocaster and Telecaster guitar. Includes all mounting hardware.



099-2074-105

American Vintage Staggered Strat/Tele, 6 pcs, nickel/chrome. Fits most vintage-style Stratocaster and Telecaster guitars.



099-2040-000

American Vintage Strat/Tele, 6 pcs, nickel. For American Vintage, Classic and Road Worn™ series Tele and Strat models, bushings and washers included.



099-2040-200

American Vintage Strat/Tele, 6 pces, gold. For American Vintage, Classic and Road Worn™ series Tele and Strat models, bushings and washers included.



099-0822-100

70s F Style Strat/Tele, 6 pces, nickel. Used on American Vintage and Classic series models. Gear ratio of 14:1. Includes all mounting hardware.



099-7201-000

Road Worn® Guitar Machine Heads, 6 pces, nickel. Includes all mounting hardware.



099-0820-100

American Professional Staggered Strat/Tele, 6 pces, chrome. For American Professional, American Standard and American Series, bushings and washers included.



099-0820-200

American Professional Staggered Strat/Tele, 6 pces, gold. For American Professional, American Standard and American Series, bushings and washers included.



099-0818-105

Locking Strat/Tele, all short post, 6 pces, chrome. Used on American Deluxe & Elite Series. Gear ratio of 18:1. Bushings and washers included.



099-0818-200

Locking Strat/Tele, 6 pces, gold. Used on American Deluxe & American Elite Series. Gear ratio of 18:1. Bushings and washers included.



099-0818-400

Locking Strat/Tele, 6 pces, black. Used on American Deluxe & American Elite Series. Gear ratio of 18:1. Bushings and washers included.



099-2040-002

LEFT-HANDED American Vintage Strat/Tele, 6 pces, nickel. For left-hand American Vintage, Classic & Road Worn™ series. Bushings and washers included.



003-6400-049

BASS Standard/Highway One™ Series, 4 pces, chrome. For Highway One, American Special, Deluxe, Blacktop + Standard series basses. Bushings & washers included.



007-6568-049

BASS Pure Vintage '70s Bass, 4 pces, chrome, with mounting screws. Used on American Vintage '74, '75 and American Original '70's Bases.



009-7335-049

BASS Deluxe «F» Stamp Bass, 4 pces, chrome. Bushings & mounting hardware included. For American Standard, Deluxe & Dimension Bass.



099-4946-000

Vintage-Style Tuning Machine Bushings, 6 pces, chrome. Press-in design, .345" outside diameter (.240" inside diameter). For Fender electric guitar w/ vintage-style tuners.



001-9509-049

BASS American Vintage Bass Tuning Machine Bushings, 4 pces, nickel. Dimensions: .875" (tuner/headstock); .743" (internal); .419" (height).



005-1532-049

BASS Bass Tuning Machine Bushings- Standard-Deluxe Series (Mexico), 4 pces, chrome. .738" outside diameter (.555" inside diameter) .353" height

golds



M1276

Classic guitar tuners, 3+3, nickel. Each side 3 open tuners on a nicely decorated metal plate. Pearl buttons. For classic guitars.



M1277

Western guitar Standard tuners, 6+6, nickel. Each side 6 open tuners on a nicely decorated metal plate. For 12-string guitars.



MB00N

Eyelet Tuner Bushings, nickel, 6pcs. Plain press-in, for vintage tuners. Diam. bottom 7.2mm, 10.5mm collar. Inner diam 6.4mm. Height 8mm



MB01C

Adapter Bushings, 8.7mm, nickel, 6pcs. Tuner Bushings, 6,3mm Ø (inner)



MB01G

Adapter Bushings, 8.7mm, gold, 6pcs. Tuner Bushings, 6,3mm Ø (inner)



MB05C

Adapter Bushings, 10mm, nickel, 6pcs. To install vintage KLUSON tuners in 10mm holes. Inner diameter 6.4mm



MB05G

Adapter Bushings, 10mm, gold, 6pcs. To install vintage KLUSON tuners in 10mm holes. Inner diameter 6.4mm



MB02N

Hex Bushings for Tuning Machines, nickel, 6pcs. Appearance of a hexagonal nut. 8.8 mm Ø bottom, top 10mm. Inner Ø 6.4mm. Height 8mm



WKS RG

Spacer rings for tuner buttons, guitar, 25 black + 25 white. Increase the distance of the knob to the edge of the headstock.



WKS RB

Spacer rings for tuner buttons, bass, 25 black + 25 white. Increase the distance of the knob to the edge of the headstock.

GOTOH



GRM3T

Relic Tuners «Tulip», 3+3, aged nickel, tuners for L.P. Junior & the like



M33MC

Tuners SGE-04 «Lock», 3+3, chrome, 45°, Tulip Buttons. Drill hole 10mm.



M6VLC

Magnum Lock, 6 left, nickel Without stamp, Drill hole 8.5mm. Gear ratio 1:15.

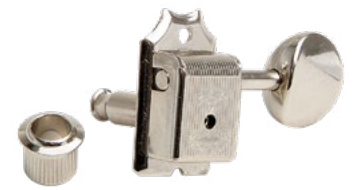

M6HPN

HAP Vintage Tuners, 6 left, nickel For F-style heads, Shaft height is individually adjustable for each tuner



GRM6L

Relic Tuners, oval button, 6 left, aged nickel. Tuners for Fender Strat, Tele and the like. Small oval knobs



M6LOC

Tuners SGE-05, 6 left, chrome, 45°, oval buttons. Drill hole 10mm



M6LOG

Tuners SGE-05, 6 left, gold, 45°, oval buttons. Drill hole 10mm



M6LMC

Tuners SGE-05 «Lock», 6 left, chrome. Locking Tuners, 45°, oval Buttons. Drill hole 10mm



M6LMG

Tuners SGE-05 «Lock», 6 left, gold. Locking Tuners, 45°, oval Buttons. Drill hole 10mm



MFL4C

BASS Tuners GB2, 4 left, nickel, classic open-type bass tuners - top quality. 1:28 gear, drill hole 17.5mm.

KLUSON

Vintage

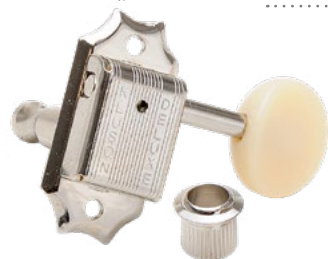

M33JP

Double Line «Junior», 3+3, nickel, for old Juniors, Melody Makers etc.. Drill hole 8.5mm. Gear ratio 1:15.



M33VC

Tuners Single Line «Tulip», 3+3, nickel, for old Les Pauls and the like. Drill hole 8.5mm. Gear ratio 1:15.

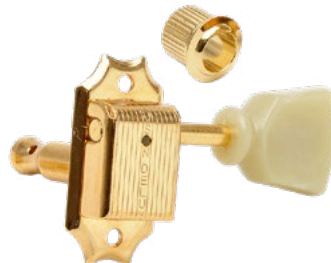

M33VG

Tuners Single Line «Tulip», 3+3, gold, for old Les Pauls and the like. Drill hole 8.5mm. Gear ratio 1:15.



M3JGN

Kluson Single Line «Junior», 3+3, nickel, Oval buttons, for old Juniors etc.. Drill hole 8.5mm. Gear ratio 1:15.



M6V0C

Tuners Vintage Deluxe, 6 left, nickel, Single Line stamp, drill hole 8.5mm. Gear ratio 1:15



M6V0G

Tuners Vintage Deluxe, 6 left, gold, Single Line stamp, drill hole 8.5mm. Gear ratio 1:15



M6VRN

Tuners Vintage Deluxe, 6 left, nickel, Single Line stamp, Gear ratio 1:15 For lefthand or reverse headstock



M90NP

Tuners «Three on a plate», 3+3, nickel 2 x 3 tuners on a mounting plate, oval white plastic knobs



MC33G

Tuners Double-Line "Tulip", 3+3, gold, single, Drill hole 8.5mm. Gear ratio 1:15

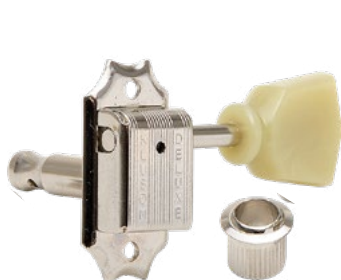

MC33N

Tuners Double-Line "Tulip", 3+3, nickel, single, Drill hole 8.5mm. Gear ratio 1:15



MC6LN

Tuners Vintage Double-Line, 6 left, nickel, Drill hole 8.5mm. Oval buttons, 6-left, gear ratio 1:15.



MC6LG

Tuners Vintage Double-Line, 6 left, gold, Drill hole 8.5mm. Oval buttons, 6-left, gear ratio 1:15.



MCD33N

Tuners Double Line "Tulip", double ring, nickel. 3+3 with tulip knob for old Les Pauls and the like. Drill hole 8.5mm.



MCD33G

Tuners Double Line "Tulip", double ring, gold. 3+3 with tulip knob for old Les Pauls and the like. Drill hole 8.5mm.



MNV3N

Tuners Open Back, 3+3, nickel. Open tuners with oval buttons, incl. bushings. Drill hole 8.5mm.



MWT3PN

'Waffle Tuners', 3+3, nickel, pearloid tulip. 1:18 ratio. Distance between the holes in the headstock 38mm. Screws and bushings included.

Roundbacks



MWT3PG

'Waffle Tuners', 3+3, gold, pearloid tulip. 1:18 ratio. Distance between the holes in the headstock 38mm. Screws and bushings included.



MWTM3N

'Waffle Tuners', 3+3, nickel, metal tulip. 1:18 ratio, adjustable. Distance between the holes in the headstock 38mm. Screws & bushings included.



MWTM3G

'Waffle Tuners', 3+3, gold, metal tulip. 1:18 ratio, adjustable. Distance between the holes in the headstock 38mm. Screws & bushings included.



MG33B

Tuners Roundbacks «Kidney», 3+3, black. 90°, Kidney buttons. Drill hole 10mm. Gear ratio 1:18.



MG33C

Tuners Roundbacks «Kidney», 3+3, chrome, 90°, Kidney buttons. Drill hole 10mm. Gear ratio 1:18.



MG33N

Tuners Roundbacks «Kidney», 3+3, nickel, 90°, Kidney buttons. Drill hole 10mm. Gear ratio 1:18.



MG33G

Tuners Roundbacks «Kidney», 3+3, gold, 90°, Kidney buttons. Drill hole 10mm. Gear ratio 1:18.



MK6LB

Tuners Roundbacks oval button, 6 left, black, 45°, Closed-type tuners of finest quality. Drill hole 10mm.



MK6LN

Tuners Roundbacks oval button, 6 left, nickel, 45°, Closed-type tuners of finest quality. Drill hole 10mm.



MK6LG

Tuners Roundbacks oval button, 6 left, gold, 45°, Closed-type tuners of finest quality. Drill hole 10mm.



MK6RB

Tuners Roundbacks oval button, 6 right, black, 45°, Closed-type tuners of finest quality. Drill hole 10mm.



MK6RN

Tuners Roundbacks oval button, 6 right, nickel, 45°, Closed-type tuners of finest quality. Drill hole 10mm.



MK6RG

Tuners Roundbacks oval button, 6 right, gold, 45°, Closed-type tuners of finest quality. Drill hole 10mm.



MS6LC

Tuners Roundbacks German button, 6 left, chrome, 45°, small. Drill hole 10mm.



MS6LG

Tuners Roundbacks German button, 6 left, gold, 45°, small. Drill hole 10mm.



MSS3C

Tuners Roundbacks German button, small, 3+3, chrome, 45°. Drill hole 10mm.



MS33C

Tuners Roundbacks German button, 3+3, chrome, 45°. Drill hole 10mm. Gear ratio 1:18.



MS33G

Tuners Roundbacks German button, 3+3, gold, 45°. Drill hole 10mm. Gear ratio 1:18.



MT33N

Tuners Roundbacks 'Tulip', 3+3, nickel, 90°. Drill hole 10mm. Gear ratio 1:18.



MT33G

Tuners Roundbacks 'Tulip', 3+3, gold, 90°. Drill hole 10mm. Gear ratio 1:18.

Special



M3ADN

Tuners Grand Jazz Roundbacks, 3+3, nickel. 3-step metal buttons, 90°. Drill hole 10mm. Gear ratio 1:18.



M3ADG

Tuners Grand Jazz Roundbacks, 3+3, gold. 3-step metal buttons, 90°. Drill hole 10mm. Gear ratio 1:18.



MD33N

Tuners Roundbacks Art Diego, 3+3, nickel. With the kidney-shape Step-Buttons! 90°, nice for Jazz Guitars! Drill hole 10mm. Gear ratio 1:18



MD33G

Tuners Roundbacks Art Diego, 3+3, gold. With the kidney-shape Step-Buttons! 90°, nice for Jazz Guitars! Drill hole 10mm. Gear ratio 1:18



MS3EC

Tuners Roundbacks Ebony, 3+3, chrome. Ebony, 45°, big buttons, Drill hole 10mm. save 70g weight per set! Gear ratio 1:18.



MS3EG

Tuners Roundbacks Ebony, 3+3, gold. Ebony, 45°, big buttons, Drill hole 10mm. save 70g weight per set! Gear ratio 1:18.



MS3EN

Tuners Roundbacks Ebony, 3+3, nickel. Ebony, 45°, big buttons, Drill hole 10mm. save 70g weight per set! Gear ratio 1:18.



MS6EC

Tuners Roundbacks Ebony, 6 left, chrome. Ebony, 45°, small buttons. Drill hole 10mm. save 70g weight per set! Gear ratio 1:18.

Lockheads



MS6EG

Tuners Roundbacks Ebony, 6 left, gold. Ebony, 45°, small buttons. Drill hole 10mm. save 70g weight per set! Gear ratio 1:18.



MS6EN

Tuners Roundbacks Ebony, 6 left, nickel. Ebony, 45°, small buttons. Drill hole 10mm. save 70g weight per set! Gear ratio 1:18.



MBG33N

Backlock Tuners, Kidney, 3+3, nickel, 90°, kidney button. Drill hole 10mm. Highest possible tuning stability.



MBG33G

Backlock Tuners, Kidney, 3+3, gold, 90°, kidney button. Drill hole 10mm. Highest possible tuning stability.



MBKL6LG

Backlock Tuners oval button, 6 left, gold, 45°, oval button. Drill hole 10mm. Gear ratio 1:18



MBKL6LN

Backlock Tuners oval button, 6 left, nickel, 45°, oval button. Drill hole 10mm. Gear ratio 1:18



MBKL6RN

Backlock Tuners oval button, 6 right, nickel, 45°, oval button. Drill hole 10mm. Gear ratio 1:18



MBS33B

Backlock Tuners German button, 3+3, black, 45°, Drill hole 10mm. Highest possible tuning stability.



MBS33C

Backlock Tuners German button, 3+3, chrome, 45°, Drill hole 10mm. Highest possible tuning stability.



MBS33G

Backlock Tuners German button, 3+3, gold, 45°, Drill hole 10mm. Highest possible tuning stability.



MBS33SC

Backlock Tuners German button, 3+3, satin chrome, 45°, Drill hole 10mm. Highest possible tuning stability.



MBSL6LB

Backlock Tuners German button (small), 6 left, black, 45°, Drill hole 10mm. Gear ratio 1:18.

**MBSL6LC**

Backlock Tuners German button (small), 6 left, chrome, 45°, Drill hole 10mm. Gear ratio 1:18.

**MBSL6LG**

Backlock Tuners German button (small), 6 left, gold, 45°, Drill hole 10mm. Gear ratio 1:18.

**MLG33B**

Lockheads Kidney-type, 3+3, black. 90°, kidney buttons. Drill hole 10mm. Gear ratio 1:18. A simple locking machine of highest quality!

**MLG33C**

Tuners Lockheads Kidney-type, 3+3, chrome. 90°, kidney buttons. Drill hole 10mm. Gear ratio 1:18. A simple locking machine of highest quality!

**MLG33G**

Tuners Lockheads Kidney-type, 3+3, gold. 90°, kidney buttons. Drill hole 10mm. Gear ratio 1:18. A simple locking machine of highest quality!

**MLG33N**

Tuners Lockheads Kidney-type, 3+3, nickel. 90°, kidney buttons. Drill hole 10mm. Gear ratio 1:18. A simple locking machine of highest quality!

**MLK6LB**

Tuners Lockheads, oval button, 6 left, black, 45°, drill hole 10mm. Gear ratio 1:18. Vintage Look with highest possible tuning stability!

**MLK6LC**

Tuners Lockheads, oval button, 6 left, chrome, 45°, drill hole 10mm. Gear ratio 1:18. Vintage Look with highest possible tuning stability!

**MLK6LN**

Tuners Lockheads, oval button, 6 left, nickel, 45°, drill hole 10mm. Gear ratio 1:18. Vintage Look with highest possible tuning stability!

**MLK6RB**

Tuners Lockheads, oval button, 6 right, black, 45°, drill hole 10mm. Gear ratio 1:18. Vintage Look with highest possible tuning stability!

**MLK6RC**

Tuners Lockheads, oval button, 6 right, chrome, 45°, drill hole 10mm. Gear ratio 1:18. Vintage Look with highest possible tuning stability!

**MLK6RN**

Tuners Lockheads, oval button, 6 right, nickel, 45°, drill hole 10mm. Gear ratio 1:18. Vintage Look with highest possible tuning stability!

**MLS33C**

Tuners Lockheads, German button, 3+3, chrome, 45°, German buttons. Drill hole 10mm. Gear ratio 1:18.

**MLS33G**

Tuners Lockheads, German button, 3+3, gold, 45°, German buttons. Drill hole 10mm. Gear ratio 1:18.

**MLT33G**

Tuners Lockheads «Tulip», 3+3, gold, 90°, tulip buttons. Drill hole 10mm. Gear ratio 1:18.

**MLT33N**

Tuners Lockheads «Tulip», 3+3, nickel, 90°, tulip buttons. Drill hole 10mm. Gear ratio 1:18.



MLV6LG

Tuners Vintage Lockheads, 6 left, gold. Drill hole 8.5mm. Gear ratio 1:15. Vintage Look with highest possible tuning stability!



MLV6LN

Tuners Vintage Lockheads, 6 left, nickel. Drill hole 8.5mm. Gear ratio 1:15. Vintage Look with highest possible tuning stability!



MKKRK

Tuning Knob, Rhombus Shape, Ivory Pearl (come in 6 pcs - prices are quoted per piece!). Fit only KLUSON Roundbacks & KLUSON Classic!



MKS1E

Ebony Buttons, German shape, small. One piece - prices are quoted per piece. Fit only KLUSON Roundbacks & KLUSON Classic!



MKS2E

Ebony Buttons, German shape, big. One piece - prices are quoted per piece. Fit only KLUSON Roundbacks & KLUSON Classic!

For Basses



MB22N

BASS Small Tuners, 2+2, nickel. Small amber buttons. Drill hole 14mm.



MF4LN

BASS Vintage Tuners, 4 left, nickel. Drill hole 18.5mm. Gear ratio 1:22. Best price-quality relation! Convertible from left to right.



MKBLB

BASS Compact Tuners, 1 left, black. Single tuners. Gear ratio 1:18, 14mm holes



MKBLC

BASS Compact Tuners, 1 left, chrome. Single tuners. Gear ratio 1:18, 14mm holes



MKBLG

BASS Compact Tuners, 1 left, gold. Single tuners. Gear ratio 1:18, 14mm holes



MKBLN

BASS Compact Tuners, 1 left, nickel. Single tuners. Gear ratio 1:18, 14mm holes



MKBRB

BASS Compact Tuners, 1 right, black. Single tuners. Gear ratio 1:18, 14mm holes



MKBRC

BASS Compact Tuners, 1 right, chrome. Single tuners. Gear ratio 1:18, 14mm holes



MKBRG

BASS Compact Tuners, 1 right, gold. Single tuners. Gear ratio 1:18, 14mm holes



MKBRN

BASS Compact Tuners, 1 right, nickel. Single tuners. Gear ratio 1:18, 14mm holes



PRN-2311-C0

Ratio Electric Tuned Machines
Heads 3+3 Contemporary Button
Chrome 2 Pin



PRN-2411-NO

ACOUSTIC Ratio Tuned Machines
Heads 3+3 Contemporary Button
Nickel 2 Pin



SC-GT-3L3R-NI

GrandTune single 3+3, nickel. Ultimate combination of tasteful design and velvet-smooth feel and touch.



SC-GT-3L3R-CH
Chrome
Single:
10510170.41.30



SC-GT-3L3R-GO
Gold



SC-GT-3L3R-SP
Satin Pearl



SC-GT-3L3R-BC
Black Chrome



SC-GT-3L3R-RU
Ruthenium



SC-M6-90-3L3R-NI-L

M6 90 3+3, locking Achse, nickel. Featuring 18:1 Velvet-Tec™ and LX6-Lube™ for unparalleled tuning precision and comfort.
6 left: **SC-M6-90-6L-NI-L**



SC-M6-90-3L3R-CH-L
Chrome
6 left:
SC-M6-90-6L-CH-L



SC-M6-90-3L3R-GO-L
Gold
6 left: **SC-M6-90-6L-GO-L**



SC-M6-90-3L3R-BC-L
Black Chrome
6 left: **SC-M6-90-6L-BC-L**



SC-M6-90-3L3R-RU-L
Ruthenium
6 left: **SC-M6-90-6L-RU-L**



SC-M6-90-3L3R-NI-TL

M6 90 3+3, Top locking Achse, nickel. Featuring 18:1 Velvet-Tec™ and LX6-Lube™ for unparalleled tuning precision and comfort.
6 left: **SC-M6-90-6L-NI-TL**



SC-M6-90-3L3R-CH-TL
Chrome
6 left:
SC-M6-90-6L-CH-TL



SC-M6-90-3L3R-GO-TL
Gold
6 left:
SC-M6-90-6L-GO-TL



SC-M6-90-3L3R-BC-TL
Black Chrome
6 left:
SC-M6-90-6L-BC-TL



SC-M6-90-3L3R-RU-TL
Ruthenium
6 left:
SC-M6-90-6L-RU-TL



SC-M6-90-3L3R-NI-SLO

M6 90 3+3, Slotted Headstock, nickel. Featuring 18:1 Velvet-Tec™ and LX6-Lube™: unparalleled tuning precision and comfort.
6 left: **SC-M6-90-6L-NI-SLO**



SC-M6-90-3L3R-CH-SLO
Chrome
6 left: **SC-M6-90-6L-CH-SLO**



SC-M6-90-3L3R-GO-SLO
Gold
6 left: **SC-M6-90-6L-GO-SLO**



SC-M6-90-3L3R-BC-SLO
Black Chrome
6 left: **SC-M6-90-6L-BC-SLO**



SC-M6-90-3L3R-RU-SLO
Ruthenium
6 left: **SC-M6-90-6L-RU-SLO**



SC-M6-90-3L3R-NI

M6 90 3+3, Solid Headstock, nickel. Featuring 18:1 Velvet-Tec™ and LX6-Lube™: unparalleled tuning precision and comfort. 6 left: **SC-M6-90-6L-NI**



SC-M6-90-3L3R-CH
Chrome
6 left: **SC-M6-90-6L-CH**



SC-M6-90-3L3R-GO
Gold
6 left: **SC-M6-90-6L-GO**



SC-M6-90-3L3R-BC
Black Chrome
6 left: **SC-M6-90-6L-BC**



SC-M6-90-3L3R-RU
Ruthenium
6 left: **SC-M6-90-6L-RU**



SC-M6-135-3L3R-NI-L

M6 135 3+3, locking Achse, nickel. Featuring 18:1 Velvet-Tec™ and LX6-Lube™ for unparalleled tuning precision and comfort.
6 left: **SC-M6-135-6L-NI-L**



SC-M6-135-3L3R-CH-L
Chrome
6 left: **SC-M6-135-6L-CH-L**



SC-M6-135-3L3R-GO-L
Gold
6 left: **SC-M6-135-6L-GO-L**



SC-M6-135-3L3R-BC-L
Black Chrome
6 left: **SC-M6-135-6L-BC-L**



SC-M6-135-3L3R-RU-L
Ruthenium
6 left: **SC-M6-135-6L-RU-L**



SC-M6-135-3L3R-NI-TL

M6 135 3+3, Top locking Achse, nickel. Featuring 18:1 Velvet-Tec™ and LX6-Lube™ for unparalleled tuning precision and comfort.
6 left: **SC-M6-135-6L-NI-TL**



SC-M6-135-3L3R-CH-TL
Chrome
6 left: **SC-M6-135-6L-CH-TL**



SC-M6-135-3L3R-GO-TL
Gold
6 left: **SC-M6-135-6L-GO-TL**



SC-M6-135-3L3R-BC-TL
Black Chrome
6 left: **SC-M6-135-6L-BC-TL**



SC-M6-135-3L3R-RU-TL
Ruthenium
6 left: **SC-M6-135-6L-RU-TL**



- | | |
|----------------------------------------------------------------------------------------------------|-------------------------------------------------------------------------------------------------|
| <p>SC-M6-135-3L3R-CH-SLO
Chrome</p> <p>6 left:
SC-M6-135-6L-CH-SLO</p> | <p>SC-M6-135-3L3R-GO-SLO
Gold</p> <p>6 left:
SC-M6-135-6L-GO-SLO</p> |
| <p>SC-M6-135-3L3R-BC-SLO
Black Chrome</p> <p>6 left:
SC-M6-135-6L-BC-SLO</p> | <p>SC-M6-135-3L3R-RU-SLO
Ruthenium</p> <p>6 left:
SC-M6-135-6L-RU-SLO</p> |

SC-M6-135-3L3R-NI-SLO

M6 135 3+3, Slotted Headstock, nickel. Featuring 18:1 Velvet-Tec™ and LX6-Lube™: unparalleled tuning precision & comfort.

6 left: **SC-M6-90-6L-NI-SLO**



- | | |
|--------------------------------------------------------------------------------------------|-----------------------------------------------------------------------------------------|
| <p>SC-M6-135-3L3R-CH
Chrome</p> <p>6 left:
SC-M6-135-6L-CH</p> | <p>SC-M6-135-3L3R-GO
Gold</p> <p>6 left:
SC-M6-135-6L-GO</p> |
| <p>SC-M6-135-3L3R-BC
Black Chrome</p> <p>6 left:
SC-M6-135-6L-BC</p> | <p>SC-M6-135-3L3R-RU
Ruthenium</p> <p>6 left:
SC-M6-135-6L-RU</p> |

SC-M6-135-3L3R-NI

M6 135 3+3, Solid Headstock, nickel. 18:1 Velvet-Tec™ and LX6-Lube™: unparalleled tuning precision & comfort. 6 left: **SC-M6-135-6L-NI**



- | | |
|------------------------------------------------------------------------------------------------|---------------------------------------------------------------------------------------------|
| <p>SC-M6-180-3L3R-CH-L
Chrome</p> <p>6 left:
SC-M6-180-6L-CH-L</p> | <p>SC-M6-180-3L3R-GO-L
Gold</p> <p>6 left:
SC-M6-180-6L-GO-L</p> |
| <p>SC-M6-180-3L3R-BC-L
Black Chrome</p> <p>6 left:
SC-M6-180-6L-BC-L</p> | <p>SC-M6-180-3L3R-RU-L
Ruthenium</p> <p>6 left:
SC-M6-180-6L-RU-L</p> |

SC-M6-180-3L3R-NI-L

M6 180 3+3, locking Achse, nickel. Featuring 18:1 Velvet-Tec™ and LX6-Lube™ for unparalleled tuning precision and comfort.

6 left: **SC-M6-180-6L-NI-L**



- | | |
|--------------------------------------------------------------------------------------------------|-----------------------------------------------------------------------------------------------|
| <p>SC-M6-180-3L3R-CH-TL
Chrome</p> <p>6 left:
SC-M6-180-6L-CH-TL</p> | <p>SC-M6-180-3L3R-GO-TL
Gold</p> <p>6 left:
SC-M6-180-6L-GO-TL</p> |
| <p>SC-M6-180-3L3R-BC-TL
Black Chrome</p> <p>6 left:
SC-M6-180-6L-BC-TL</p> | <p>SC-M6-180-3L3R-RU-TL
Ruthenium</p> <p>6 left:
SC-M6-180-6L-RU-TL</p> |

SC-M6-180-3L3R-NI-TL

M6 180 3+3, Top locking Achse, nickel. 18:1 Velvet-Tec™+LX6-Lube™ for unparalleled tuning precision & comfort.

6 left: **SC-M6-180-6L-NI-TL**



SC-M6-180-3L3R-CH-SLO
Chrome
6 left:
SC-M6-180-6L-CH-SLO



SC-M6-180-3L3R-GO-SLO
Gold
6 left:
SC-M6-180-6L-GO-SLO



SC-M6-180-3L3R-BC-SLO
Black Chrome
6 left:
SC-M6-180-6L-BC-SLO



SC-M6-180-3L3R-RU-SLO
Ruthenium
6 left:
SC-M6-180-6L-RU-SLO

SC-M6-180-3L3R-NI-SLO

M6 180 3+3, Slotted Headstock, nickel. Featuring 18:1 Velvet-Tec™ and LX6-Lube™ for unparalleled tuning precision and comfort. 6 left: **SC-M6-180-6L-NI-SLO**



SC-M6-180-3L3R-CH
Chrome
6 left:
SC-M6-180-6L-CH



SC-M6-180-3L3R-GO
Gold
6 left:
SC-M6-180-6L-GO



SC-M6-180-3L3R-BC
Black Chrome
6 left:
SC-M6-180-6L-BC



SC-M6-180-3L3R-RU
Ruthenium
6 left:
SC-M6-180-6L-RU

SC-M6-180-3L3R-NI

M6 180 3+3, Solid Headstock, nickel. 18:1 Velvet-Tec™ + LX6-Lube™: unparalleled tuning precision & comfort. 6 left: **SC-M6-180-6L-NI-L**



SC-M6-PIN-3L3R-CH-L
Chrome
6 left:
SC-M6-PIN-6L-CH-L



SC-M6-PIN-3L3R-GO-L
Gold
6 left:
SC-M6-PIN-6L-GO-L



SC-M6-PIN-3L3R-BC-L
Black Chrome
6 left:
SC-M6-PIN-6L-BC-L



SC-M6-PIN-3L3R-RU-L
Ruthenium
6 left:
SC-M6-PIN-6L-RU-L

SC-M6-PIN-3L3R-NI-L

M6 PIN 3+3, locking Achse, nickel. Featuring 18:1 Velvet-Tec™ and LX6-Lube™ for unparalleled tuning precision and comfort. 6 left: **SC-M6-PIN-6L-NI-L**



SC-M6-PIN-3L3R-CH-TL
Chrome
6 left:
SC-M6-PIN-6L-CH-TL



SC-M6-PIN-3L3R-GO-TL
Gold
6 left:
SC-M6-PIN-6L-GO-TL



SC-M6-PIN-3L3R-BC-TL
Black Chrome
6 left:
SC-M6-PIN-6L-BC-TL



SC-M6-PIN-3L3R-RU-TL
Ruthenium
6 left:
SC-M6-PIN-6L-RU-TL

SC-M6-PIN-3L3R-NI-TL

M6 PIN 3+3, Top locking Achse, nickel. Featuring 18:1 Velvet-Tec™ and LX6-Lube™ for unparalleled tuning precision and comfort. 6 left: **SC-M6-PIN-6L-NI-TL**



SC-M6-PIN-3L3R-CH
Chrome
6 left: **SC-M6-PIN-6L-CH**

SC-M6-PIN-3L3R-GO
Gold
6 left: **SC-M6-PIN-6L-GO**

SC-M6-PIN-3L3R-BC
Black Chrome
6 left: **SC-M6-PIN-6L-BC**

SC-M6-PIN-3L3R-RU
Ruthenium
6 left: **SC-M6-PIN-6L-RU**

SC-M6-PIN-3L3R-NI

M6 PIN 3+3, Solid Headstock, nickel. 18:1 Velvet-Tec™ and LX6-Lube™ for unparalleled tuning precision and comfort. 6 left: **SC-M6-PIN-6L-NI**



SC-M6-MINI-3L3R-CH
Chrome
6 left: **SC-M6-MINI-6L-CH**

SC-M6-MINI-3L3R-BC
Black Chrome
6 left: **SC-M6-MINI-6L-BC**

SC-M6-MINI-3L3R-GO
Gold
6 left: **SC-M6-MINI-6L-GO**



SC-M6-MINI-3L3R-CH-TL
Chrome
6 left: **SC-M6-MINI-6L-CH-TL**

SC-M6-MINI-3L3R-BC-TL
Black Chrome
6 left: **SC-M6-MINI-6L-BC-TL**

SC-M6-MINI-3L3R-GO-TL
Gold
6 left: **SC-M6-MINI-6L-GO-TL**

SC-M6-MINI-3L3R-NI

M6 MINI 3+3, nickel. Smaller & lighter version for Strat models, small headstocks or 12-string guitars. 6 left: **SC-M6-MINI-6L-NI**

SC-M6-MINI-3L3R-NI-TL

M6 MINI 3+3, nickel. Smaller & lighter version for Strat models, small headstocks or 12-string guitars. 6 left: **SC-M6-MINI-6L-NI-TL**



SC-M6-V-3L3R-CH-VB
Chrome
LAST ONES



SC-F-6L-CH-STD
Chrome

SC-F-6L-BC-STD
Black Chrome

SC-F-6L-GO-STD
Gold

SC-M6-V-3L3R-NI-VB

M6 Vintage 3+3, nickel. Vintage step-button. Vintage look & optimised gear ratio.

SC-F-6L-NI-STD

F-Series Standard 6L, nickel. For Fender style guitars. Original look and specs with cutting-edge Schaller technology. Gear ratio 1:18



SC-F-6L-CH-L
Chrome

SC-F-6L-BC-L
Black Chrome

SC-F-6L-GO-L
Gold



SC-F-6L-CH-70
Chrome

SC-F-6L-BC-70
Black Chrome

SC-F-6L-GO-70
Gold

SC-F-6L-NI-STD

F-Series Locking 6L, nickel. Staggered string posts (3/3). For Fender style guitars. Original look and specs with cutting-edge Schaller technology. Gear ratio 1:18

SC-F-6L-NI-70

Original F-Series 70's, 6L, nickel. For Fender style guitars. Original look and specs with cutting-edge Schaller technology. Gear ratio 1:14



SC-G-3L3R-NI-SR
G-Series Deluxe KeyStone, Single Ring 3+3, nickel. Feature vintage original specs along with that classic look and feel.



SC-G-3L3R-GO-SR
G-Series Deluxe KeyStone, Single Ring 3+3, gold. Feature vintage original specs along with that classic look and feel.



SC-G-3L3R-NI-SR-TL
G-Series Deluxe KeyStone, Single Ring, Top Locking, 3+3, nickel. Feature vintage original specs along with that classic look and feel.



SC-G-3L3R-GO-SR-TL
G-Series Deluxe KeyStone, Single Ring, Top Locking, 3+3, gold. Feature vintage original specs along with that classic look and feel.



SC-G-3L3R-NI-DR
G-Series Deluxe KeyStone, Double Ring 3+3, nickel. Feature vintage original specs along with that classic look and feel.



SC-G-3L3R-GO-DR
G-Series Deluxe KeyStone, Double Ring 3+3, gold. Feature vintage original specs along with that classic look and feel.



SC-DV-3L3R-NI
Da Vinci 3+3, nickel. A state-of-the-art tuning machine featuring ultra smooth action and unparalleled tuning stability.
6 left: **SC-DV-6L-NI**



SC-DV-3L3R-CH
Chrome
6 left:
SC-DV-6L-CH



SC-DV-3L3R-BC
Black Chrome
6 left:
SC-DV-6L-BC



SC-DV-3L3R-GO
Gold
6 left:
SC-DV-6L-GO



SC-B-DV-2L2R-NI
BASS Da Vinci 2+2, nickel. Ultra smooth action, unparalleled tuning stability.
3+2: **SC-B-DV-3L2R-NI**
4 left: **SC-B-DV-4L-NI**



SC-B-DV-2L2R-CH
Chrome
3+2: **SC-B-DV-3L2R-CH**
4 left: **SC-B-DV-4L-CH**



SC-B-DV-2L2R-BC
Black Chrome
3+2: **SC-B-DV-3L2R-BC**
4 left: **SC-B-DV-4L-BC**



SC-B-DV-2L2R-GO
Gold
3+2: **SC-B-DV-3L2R-GO**
4 left: **SC-B-DV-4L-GO**



SC-B-BM-2L2R-NI
BASS BM 2+2, nickel. Vintage-style bass tuner. High precision.
3+2: **SC-B-BM-3L2R-NI**
4 left: **SC-B-BM-4L-NI**



SC-B-BM-2L2R-CH
Chrome
3+2: **SC-B-BM-3L2R-CH**
4 left: **SC-B-BM-4L-CH**



SC-B-BM-2L2R-BC
Black Chrome
3+2: **SC-B-BM-3L2R-BC**
4 left: **SC-B-BM-4L-BC**



SC-B-BM-2L2R-GO
Gold
3+2: **SC-B-BM-3L2R-GO**
4 left: **SC-B-BM-4L-GO**



SC-B-BML-2L2R-NI
BASS BM Light 2+2, nickel. Vintage-style bass tuner. High precision.
3+2: **SC-B-BML-3L2R-NI**
4 left: **SC-B-BML-4L-NI**



SC-B-BML-2L2R-CH
Chrome
3+2: **SC-B-BML-3L2R-CH**
4 left: **SC-B-BML-4L-CH**



SC-B-BML-2L2R-BC
Black Chrome
3+2: **SC-B-BML-3L2R-BC**
4 left: **SC-B-BML-4L-BC**



SC-B-BML-2L2R-GO
Gold
3+2: **SC-B-BML-3L2R-GO**
4 left: **SC-B-BML-4L-GO**



SC-B-BMF-3L2R-NI
BASS Original F-Series BMF 3+2, nickel. Perfect replacement tuner for Fender Jazz and Precision™ basses. Counterfort-mount.
4 left: **SC-B-BMF-4L-NI**



SC-B-BMF-3L2R-CH
Chrome
4 left: **SC-B-BMF-4L-CH**



SC-B-BMF-3L2R-BC
Black Chrome
4 left: **SC-B-BMF-4L-BC**



SC-B-BMF-3L2R-GO
Gold
4 left: **SC-B-BMF-4L-GO**



SC-B-M4SL-2L2R-NI

BASS M4S Light 3+2, nickel. Half-open bass tuner with extra strong gear & an appropriately sized string post.
4 left: **SC-B-M4SL-4L-NI**



SC-B-M4SL-2L2R-CH
Chrome

4 left: **SC-B-M4SL-4L-CH**



SC-B-M4SL-2L2R-BC
Black Chrome

4 left: **SC-B-M4SL-4L-BC**



SC-B-M4SL-2L2R-GO
Gold

4 left: **SC-B-M4SL-4L-GO**



SC-B-M490L-2L2R-NI

BASS M4 90 (Light) 2+2, nickel. Elegance & Lightness for the Bass Age.
3+2: **SC-B-M490L-3L2R-NI**
4 left: **SC-B-M490L-4L-NI**



SC-B-M490L-2L2R-CH
Chrome

3+2:
SC-B-M490L-3L2R-CH
4 left: **SC-B-M490L-4L-CH**



SC-B-M490L-2L2R-GO
Gold

3+2:
SC-B-M490L-3L2R-GO
4 left: **SC-B-M490L-4L-GO**



SC-B-M490L-2L2R-BC
Black Chrome

3+2:
SC-B-M490L-3L2R-BC
4 left: **SC-B-M490L-4L-BC**



SC-B-M490L-2L2R-R
Ruthenium

3+2:
SC-B-M490L-3L2R-RU
4 left: **SC-B-M490L-4L-RU**



SC-LYRA-NI-EB

CLASSIC GUITAR Lyra, nickel, Buttons Ebony. Precision-manufactured and mounted with precisely the correct spacing on a warp-proof baseplate.



SC-LYRA-NI-AC
Nickel
Buttons Acrylic



SC-LYRA-GO-EB
Gold
Buttons Ebony



SC-LYRA-GO-AC
Gold
Buttons Acrylic



SC-HAUSER-NI-EB

CLASSIC GUITAR Hauser, nickel, Buttons Ebony. Precision-manufactured and mounted with precisely the correct spacing on a warp-proof baseplate.



SC-HAUSER-NI-AC
Nickel, Buttons Acrylic



SC-HAUSER-GO-EB
Gold, Buttons Ebony



SC-HAUSER-GO-AC
Gold, Buttons Acrylic



SC-GT-LYRA-NI

CLASSIC GUITAR Lyra, nickel. With its cutting edge Velvet-Tec the all new Schaller GrandTune® is the ultimate combination of tasteful design and velvet-smooth feel and touch.



SC-GT-LYRA-BC
Black Chrome



SC-GT-LYRA-GO
Gold



SC-GT-LYRA-RU
Ruthenium



SC-GT-LYRA-SP
Satin Pearl



SC-GT-LYRA-SB
Satin Black



SC-GT-LYRA-SG
Satin Gold



SC-GT-HAUSER-NI

CLASSIC GUITAR Hauser, nickel. With its cutting edge Velvet-Tec the all new Schaller GrandTune® is the ultimate combination of tasteful design and velvet-smooth feel and touch.



SC-GT-HAUSER-BC
Black Chrome



SC-GT-HAUSER-GO
Gold



SC-GT-HAUSER-RU
Ruthenium



SC-GT-HAUSER-SP
Satin Pearl



SC-GT-HAUSER-SB
Satin Black



SC-GT-HAUSER-SG
Satin Gold



SC-GT-MAN-A-NI-SLO

MANDOLIN GrandTune A-Style, nickel. Ultimate combination of tasteful design & velvet-smooth feel and touch.

F-Style: **SC-GT-MAN-F-NI-SLO**



SC-GT-MAN-A-BC-SLO
Black Chrome

F-Style
SC-GT-MAN-F-BC-SLO



SC-GT-MAN-A-SP-SLO
Satin Pearl

F-Style
SC-GT-MAN-F-SP-SLO



SC-GT-MAN-A-GO-SLO
Gold

F-Style
SC-GT-MAN-F-GO-SLO



SC-GT-MAN-A-SG-SLO
Satin Gold

F-Style
SC-GT-MAN-F-SG-SLO



LAST ONES

SC-B4-NI

BANJO B4, nickel. 5-wheel planetary gear. Locking mechanism built into the button. Central planetary drive.



LAST ONES

SC-B4-BC
Black Chrome



LAST ONES

SC-B5-NI

BANJO B5, gold. With self-locking worm gear. Installation as 5th tuning peg on the side of the neck.



SC-11010100

M6 Button small metal, pc., nickel. Bore hole: inner diameter 4.2 mm with driving surface (3.6 mm from surface to surface)

Large: **SC-11020100**



Chrome - **SC-11010200**
Large: **SC-11020200**



Black Chrome - **SC-11010400**
Large: **11020400**



Gold - **SC-11010500**
Large: **SC-11020500**



Ruthenium - **SC-11010600**
Large: **SC-11020600**



Small Ebony: **SC-11054400**
Large Ebony: **SC-11064400**



SC-11034100

M6 Button small Pearlloid, pc.. Bore hole: inner diameter 4.2 mm with driving surface (3.6 mm from surface to surface)

Large Pearlloid: **SC-11044100**



SC-11220100

M4 Light Button, pc., nickel.



Chrome
SC-11220200



Black Chrome
SC-11220400



Gold
SC-11220500



Ruthenium
SC-11220600



SC-21030100

GT + 70's press-in bushings, set of 6, nickel. Press-in Bushings (round, inner diameter 6,1mm, outside diameter 10mm, conical)



Chrome
SC-21030200



Black Chrome
SC-21030400



Gold
SC-21030500



Ruthenium
SC-21030600

TREMOLOS & PARTS



DIEGO

Fender-Style Tremolos

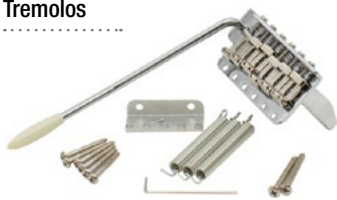

TVA1C

Diego Deluxe SC Tremolo, with alu block, chrome. Fits any old Strat, mount screw spacing original (56mm), string spacing only 54mm - 1mm more space at the fingerboard edge.



TVA1G

Diego Deluxe SC Tremolo, with alu block, gold. Fits any old Strat, mount screw spacing original (56mm), string spacing only 54mm - 1mm more space at the fingerboard edge.



TVS1C

Diego Deluxe SC Tremolo, with steel block, chrome. Fits any old Strat, mount screw spacing original (56mm), string spacing only 54mm - 1mm more space at the fingerboard edge.



TVS1G

Diego Deluxe SC Tremolo, with steel block, gold. Fits any old Strat, mount screw spacing original (56mm), string spacing only 54mm - 1mm more space at the fingerboard edge.



DUESENBERG

Duesenberg Tremolos



TM85C

Les Trem II, chrome. Mounted in place of a stop tailpiece. The distance between the bolts must be exactly 81.5mm. No drilling, no routing.



TM85G

Les Trem II, gold. Mounted in place of a stop tailpiece. The distance between the bolts must be exactly 81.5mm. No drilling, no routing.



TM85N

Les Trem II, nickel. Mounted in place of a stop tailpiece. The distance between the bolts must be exactly 81.5mm. No drilling, no routing.



TM85LC

Les Trem II LEFT, chrome. Mounted in place of a stop tailpiece. The distance between the bolts must be exactly 81.5mm. No drilling, no routing.



TM85LG

Les Trem II LEFT, gold. Mounted in place of a stop tailpiece. The distance between the bolts must be exactly 81.5mm. No drilling, no routing.



TM85LN

Les Trem II LEFT, nickel. Mounted in place of a stop tailpiece. The distance between the bolts must be exactly 81.5mm. No drilling, no routing.



TDRSA

Radiator Tremola, short, alu. The short version for solidbody and thin-line guitars. String spacing 6mm, so the strings run slightly fan-shaped.



TDRSG

Radiator Tremola, short, gold. The short version for solidbody and thin-line guitars. String spacing 6mm, so the strings run slightly fan-shaped.



TDRSN

Radiator Tremola, short, nickel. The short version for solidbody and thinline guitars. String spacing 6mm, so the strings run slightly fan-shaped.



TDRSLA

Radiator Tremola LEFT, short, alu. The short version for solidbody and thinline guitars. String spacing 6mm, so the strings run slightly fan-shaped.



TDRSLG

Radiator Tremola LEFT, short, gold. The short version for solidbody and thinline guitars. String spacing 6mm, so the strings run slightly fan-shaped.



TDRSLN

Radiator Tremola LEFT, short, nickel. The short version for solidbody and thinline guitars. String spacing 6mm, so the strings run slightly fan-shaped.

**TDRLA**

Radiator Tremola, long, alu. Elegant «Radiator Grill» design. The string spacing at the axle is 6mm narrower, so the strings run slightly fan-shaped.

**TDRLG**

Radiator Tremola, long, gold. Elegant «Radiator Grill» design. String spacing at the axle is 6mm narrower, so the strings run slightly fan-shaped.

**TDRLN**

Radiator Tremola, long, nickel. Elegant «Radiator Grill» design. String spacing at the axle is 6mm narrower, so the strings run slightly fan-shaped.

**TDRLLA**

Radiator Tremola LEFT, long, alu. Elegant «Radiator Grill» design. The string spacing at the axle is 6mm narrower, so the strings run slightly fan-shaped.

**TDRLLG**

Radiator Tremola LEFT, long, gold. Elegant «Radiator Grill» design. String spacing at the axle is 6mm narrower, so the strings run slightly fan-shaped.

**TDRLLN**

Radiator Tremola LEFT, long, nickel. Elegant «Radiator Grill» design. String spacing at the axle is 6mm narrower, so the strings run slightly fan-shaped.

**TDBSA**

Diamond Deluxe Tremola, short, alu. Standard on most Duesenberg guitars. The 360° rotatable round arm lies comfortably in your hand.

**TDBSG**

Diamond Deluxe Tremola, short, gold. Standard on most Duesenberg guitars. The 360° rotatable round arm lies comfortably in your hand.

**TDBSN**

Diamond Deluxe Tremola, short, nickel. Standard on most Duesenberg guitars. The 360° rotatable round arm lies comfortably in your hand.

**TDBSLA**

Diamond Deluxe Tremola LEFT, short, alu. Standard on most Duesenberg guitars. The 360° rotatable round arm lies comfortably in your hand.

**TDBSLG**

Diamond Deluxe Tremola LEFT, short, gold. Standard on most Duesenberg guitars. The 360° rotatable round arm lies comfortably in your hand.

**TDBSLN**

Diamond Deluxe Tremola LEFT, short, nickel. Standard on most Duesenberg guitars. 360° rotatable round arm lies comfortably in your hand.

**TDBLA**

Diamond Deluxe Tremola, long, alu. Standard on most Duesenberg guitars. The 360° rotatable round arm lies comfortably in your hand.

**TDBLG**

Diamond Deluxe Tremola, long, gold. Standard on most Duesenberg guitars. The 360° rotatable round arm lies comfortably in your hand.

**TDBLN**

Diamond Deluxe Tremola, long, nickel. Standard on most Duesenberg guitars. The 360° rotatable round arm lies comfortably in your hand.

**TDBLLA**

Diamond Deluxe Tremola LEFT, long, alu. Standard on most Duesenberg guitars. The 360° rotatable round arm lies comfortably in your hand.



TDBLLG

Diamond Deluxe Tremola LEFT, long, gold. Standard on most Duesenberg guitars. The 360° rotatable round arm lies comfortably in your hand.



TDBLLN

Diamond Deluxe Tremola LEFT, long, nickel. Standard on most Duesenberg guitars. The 360° rotatable round arm lies comfortably in your hand.



HWMBC

Multibender, chrome. Lots of innovative details! Unbelievable realistic pedal steel sounds when using open tunings in slide style playing or on a lap steel. String guidance friction-free.



HWMBC-H

Multibender Lever, chrome. Extension lever for Duesenberg Multibender. Up to five levers can be mounted on the Multibender.

Fender

Strat Tremolos



099-2049-000

American Vintage Series Strat Tremolo Assemblies, chrome. Vintage-style 2-3/16" mounting spacing.



099-2049-200

American Vintage Series Strat Tremolo Assemblies, gold. Vintage-style 2-3/16" mounting spacing.



099-2049-002

American Vintage Series Strat Tremolo Assemblies LEFT, chrome. Vintage-style 2-3/16" mounting spacing.



009-4247-049

Pure Vintage Stratocaster Tremolo Assembly, chrome. Completely retooled to vintage specs for crisp, clean look and feel. Used on Am. Vintage '56, '59, and '65 Strat guitars.

Archtop Tremolos



086-8013-001

Bigsby B3 Vibrato Kit, nickel. Offers expressively shimmering vibrato for your archtop guitar.

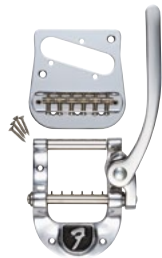

086-8013-004

Bigsby B5 Kit, chrome-plated, with F logo. Give your favorite Fender Telecaster a new look and an extra shot of classic Bigsby tone.

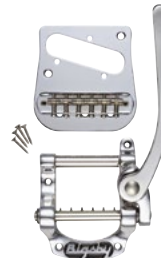

086-8013-002

Bigsby B5 Kit, chrome-plated, with Bigsby logo. Give your favorite Fender Telecaster a new look and an extra shot of classic Bigsby tone.



086-8013-003

Bigsby B5 Kit, chrome-plated, with Bigsby logo. Give your guitar a new look and an extra shot of classic Bigsby tone. For Flat Top Solidbody style (Gibson)



086-8013-005

Bigsby B7 Kit, chrome, with Bigsby logo. Original Kalamazoo Line, for Arch Top Solidbody guitar. Can be used on Les Paul, SG, ES range and more.



180-1295-700

Bigsby B700 Kit, chrome, with Bigsby logo. Adds depth & texture to your sound. Great for arch-top solid body and thin hollow body guitars including Les Paul® and ES® models.



180-1295-702

Bigsby B700 Kit, black, with Bigsby logo. Adds depth & texture to your sound. Great for arch-top solid body and thin hollow body guitars including Les Paul® and ES® models.

golds

Fender-Style Tremolos

**TPS1C**

PRS-Style Tremolo, nickel. Adjustable plug-in arm (4.5mm). Steel block. String spacing 52mm. Distance of the outer screws 53mm.

**TV10C**

Vintage Tremolo, zinc bloc, chrome. Made exactly according to the original from the 50's. With a zinc block + pressed steel string saddles

**TV10S**

Vintage Tremolo, chrome. Made exactly according to the original from the 50's. With a steel block and pressed steel string saddles.

**TV10G**

Vintage Tremolo, gold. Made exactly according to the original from the 50's. With a steel block and pressed steel string saddles.

**TV10V**

Vintage Tremolo, «aged» antique nickel saddles, chrome/antique. All original, steel tremolo block, pressed saddles.

**TV11C**

Modern «Dual Stud» Tremolo, chrome. Modern slim design, low-friction conical bearing on two precise edges, extremely wide clearance

Misc. Tremolos

**TMM1N**

Maestro Type Tremolo, nickel. For flat or archtop guitars. The frame is mounted at the end of the body like a trapeze tailpiece.

**TF47B**

Lic. Floyd Rose Tremolo, 7-string, black. Complete, incl. locking nut. The width of the nut is 48mm.

**TLT1N**

LT1 Tremolo, nickel. Licensed by Duesenberg - Mounted in place of a stop tailpiece. No drilling, no routing, screw into the 2 existing threaded bushings with the enclosed bolts.

**TLT1G**

LT1 Tremolo, gold. Licensed by Duesenberg - Mounted in place of a stop tailpiece. No drilling, no routing, screw into the 2 existing threaded bushings with the enclosed bolts.

GOTOH®

Fender-Style Tremolos

**GRTVT**

Relic Vintage Tremolo, aged chrome. Vintage tremolo for Strat. Steel block and steel saddles. Screws with US-threads. String spacing 11.3mm.

**TMW1C**

Wilkinson VS-100, chrome. Two bearing studs against a straight blade, fixed steel saddles (54mm string spacing) and an easily detachable plug-in arm.

**TMW1B**

Wilkinson VS-100, black. Two bearing studs against a straight blade, fixed steel saddles (54mm string spacing) and an easily detachable plug-in arm.

**TMW1G**

Wilkinson VS-100, gold. Two bearing studs against a straight blade, fixed steel saddles (54mm string spacing) and an easily detachable plug-in arm.

Floyd Rose Tremolos



VSVG

Wilkinson VSV, nickel. Steel base plate, steel block, pressed saddles.

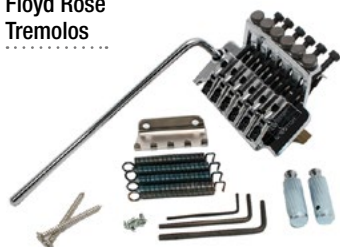

TF40C

Floyd Rose Tremolo, chrome. With hardened steel base plate. Distance between studs 74mm, string spacing 54mm, block height 40mm



TF40B

Floyd Rose Tremolo, black. With hardened steel base plate. Distance between studs 74mm, string spacing 54mm, block height 40mm



SC-LM6-NI

Lockmeister® 6, nickel. Offers a 2nd to none C45-steel ground plate, crafted in Germany. Improved sound & sustain. Superior tremolo perf.

Left: **SC-LM6-NI-LEFT**



SC-LM6-CH

Chrome

Left: **SC-LM6-CH-LEFT**



SC-LM6-GO

Gold

Left: **SC-LM6-GO-LEFT**



SC-LM6-SC

Satin Chrome

Left: **SC-LM6-SC-LEFT**



SC-LM6-RU

Ruthenium

Left: **SC-LM6-RU-LEFT**



SC-LM6-BC

Black Chrome

Left: **SC-LM6-BC-LEFT**



SC-LM7-NI

Lockmeister® 7, nickel. Offers a 2nd to none C45-steel ground plate, crafted in Germany. Improved sound & sustain. Superior tremolo perf.



SC-LM7-CH

Chrome



SC-LM7-GO

Gold



SC-LM7-SC

Satin Chrome



SC-LM7-RU

Ruthenium



SC-LM7-BC

Black Chrome



SC-ST-NI

Schaller Tremolo, nickel. Perfect sound transmission and an extremely long sustain. Same dimensions as the Floyd Rose Tremolo



SC-ST-CH

Chrome



SC-ST-GO

Gold



SC-ST-BC

Black Chrome



SC-ST-RU

Ruthenium



SC-VT-NI

Vintage Tremolo, nickel. Outstanding sustain. Roller bridge saddles fix the strings in their optimum position.



SC-VT-CH
Chrome



SC-VT-GO
Gold



SC-VT-BC
Black Chrome



SC-VT-RU
Ruthenium



SC-VT-KTS-NI-SS

Vintage Tremolo powered by KTS (Strat style saddles), nickel. Titanium - very light, durable, resistant to corrosion



SC-VT-KTS-CH-SS
Chrome



SC-VT-KTS-GO-SS
Gold



SC-VT-KTS-BC-SS
Black Chrome



SC-VT-KTS-RU-SS
Ruthenium



SC-VT-KTS-NI-BS

Vintage Tremolo powered by KTS (block style saddles), nickel. Titanium - very light, durable, resistant to corrosion



SC-VT-KTS-CH-BS
Chrome



SC-VT-KTS-GO-BS
Gold



SC-VT-KTS-BC-BS
Black Chrome



SC-VT-KTS-RU-BS
Ruthenium

DIEGO

Supplies



SRP0C

Bearing Screws, nickel (6 pieces) Reduced friction on vintage tremolos.



DUESENBERG

Arms



HWB1N

"Round" Arm, 6mm, for Duesenberg Tremola, 20cm, nickel. Requires a corresponding mount on the tremolo (not included!).



HWB1G

"Round" Arm, 6mm, for Duesenberg Tremola, 20cm, gold. Requires a corresponding mount on the tremolo (not included!).



HWB2N

"Round" Arm, 6mm, for Duesenberg Tremola, 25cm, nickel. Requires a corresponding mount on the tremolo (not included!).

Supplies



HWB2G

"Round" Arm, 6mm, for Duesenberg Tremola, 25cm, gold. Requires a corresponding mount on the tremolo (not included!).



MPTM5

Duesenberg Tremola Adapter. A simple piece of stainless steel you can mount on the bushings of any Les Paul, SG, ES stop tailpiece.



TM8ZC

Mounting-Stud for Les Trem 1. US, chrome. Single pieces, (US-size) threads technically: UNF 5/16» '24.



TM8ZG

Mounting-Stud for Les Trem 1. US, gold. Single pieces, (US-size) threads technically: UNF 5/16» '24.

Fender

Arms



099-2039-000

American Vintage Strat Tremolo Arms, chrome. Screw-in tremolo arm with white tip for use on most right-handed American Vintage series Strat models from 1986-present.



099-2039-200

American Vintage Strat Tremolo Arms, gold. Screw-in tremolo arm with white tip for use on most right-handed American Vintage series Strat models from 1986-present.



099-2039-102

American Vintage Strat Tremolo Arms LEFT, chrome. Screw-in tremolo arm with white tip for use on most right-handed American Vintage series Strat models from 1986-present.



003-5958-001

Standard Series Tremolo Arms (Pre '06), chrome with Aged White Tip. For Mexico-made Standard series models manufactured (pre-2006)



099-2092-000

Pure Vintage '50s Strat Tremolo Arm Kit. 1 Tremolo Arm + 1 Vintage White Tip + 1 Eggshell Tip. Vintage-accurate chrome-plated tremolo arm with '50s-era break angle.



099-2093-000

Pure Vintage '60s Strat Tremolo Arm Kit. 1 Tremolo Arm + 1 Vintage White Tip + 1 Eggshell Tip. Vintage-accurate chrome-plated tremolo arm with '60s-era break angle.



099-2054-000

American Standard-American Series Strat Tremolo Arms, chrome. Screw-in tremolo arm w/ white tip for use with American & American Strd series Strat from 1986-present.



099-2054-102

American Strd-American Strat Tremolo Arms LEFT, chrome. Screw-in tremolo arm w/ white tip for American & American Strd Strat from 1986-present.



099-2310-100

Standard Series Strat Tremolo Arms, chrome. Tremolo arm with white tip, for use on Strd and Deluxe series Strat from 1986-present.



099-2310-200

Standard Series Strat Tremolo Arms, gold. Tremolo arm with white tip, for use on most Standard & Dixie series Strat from 1986-present.



099-2300-100

Deluxe Locking Bridge Strat Tremolo Arm, chrome. Use on American Deluxe Strat models with deluxe locking tremolo systems. Tip not included



003-6534-049

Elite-Deluxe Strat Snap-In Tremolo Arms, stainless steel. Use on American Deluxe & Ultra series Strat models from 1986-present. Tip not included.



007-3643-000
Highway One-American Special Tremolo Arms, chrome. For American Special and Highway One™ series guitars & Standard 10-32 threading.



770-9929-049
American Professional Trem Arm w/Aged White Tip, chrome. A pop-in tremolo arm (not a screw-in) with an aged white plastic tip. Length is 6".



006-0004-000
Standard Series Strat Tremolo Arm LEFT, chrome. For most left-handed Standard and Deluxe Series Strat models from 1986-present.



005-4473-049
American Vintage Jaguar-Jazzmaster Tremolo Arm, chrome. For Am. Vintage series Jaguar & Jazzmaster from 1998-present. Tip not included.

Tips



026-4261-000
Jaguar®/Jazzmaster® Tremolo Arm Tip (Import), chrome. With white tip, for use on Japanese-made Jazzmaster and Jaguar guitars.



003-5566-000
'65 Mustang™ Tremolo Arms, chrome. With white tip for Classic Series '65 Mustang and Jag-Stang® guitars.



099-4933-000
Stratocaster® Tremolo Arm Tips, aged white. Set of 2 tremolo tips for American, Standard, Vintage, Classic Player and Artist series Stratocaster.



099-4934-000
Stratocaster® Tremolo Arm Tips, black. Set of 2 tremolo tips for American, Standard, Vintage, Classic Player and Artist series Stratocaster.

Supplies



099-4935-000
Stratocaster® Tremolo Arm Tips, white. Set of 2 tremolo tips for American, Standard, Vintage, Classic Player and Artist series Stratocaster



009-4281-049
Pure Vintage Stratocaster® Tremolo Arm Tip, aged white. Same specs as early Fender parts, to give a shot of vintage-accurate looks & tone.



099-0811-000
Hipshot™ Tremsetter. Mechanism replaces center tremolo spring. Compatible with most vintage-style and modern tremolo-equipped Strat.



001-8671-049
Tremolo Tension Springs. Set of six replacement tremolo tension springs. Used on most American Series, Deluxe & Standard Strat (86-Present).



003-1643-049
American Vintage Tremolo Tension Springs (Pack of 5), nickel-plated. For American Vintage series and Custom Shop instruments.



099-4931-000
American Series Strat Tremolo Arm Tension Springs, 12pcs. For a variety of Stratocaster models.



001-9281-049
American Vintage Strat. Tremolo Intonation Springs. Fits American Vintage, Strd (2008-Present), Road Worn®, Classic Player + Classic Strat.



001-9394-049
American Deluxe/American Strat. Intonation Springs. Tall 3/8" (for A,D,B, High E String), Black (12).



Arms



TM11C
F-style Tremolo Arm, chrome/white.
Threads: M5 / 5mm



TM11G
F-style Tremolo Arm, gold/white.
Threads: M5 / 5mm



TM11B
F-style Tremolo Arm, black.
Threads: M5 / 5mm



TM15C
Lefthand Tremolo Arm, F-style,
chrome/white. Threads: M5 / 5mm



TM18C
Tremolo Arm, 6mm, chrome.
Threads: M6



TM18B
Tremolo Arm, 6mm, black. Threads:
M6



TM21N
Maestro Style Tremolo Arm, nickel.
Specially shaped, large plastic tip.
Overall length 19.5cm, 6mm Ø. Nickel
plated. Tip: semi-transparent ivory.



TMBFN
Flat Tremolo Arm, chrome. Flat
Bigsby style tremolo arm. Length
16.5mm. Incl. spring washer and self-
locking nut.

Tips



TMBRN
Round Tremolo Arm, nickel. Round
arm for Bigsby or Duesenberg style
tremolos. Length 20cm, 6mm Ø,
metal tip.



TAC5K
Retro Tip for Tremolo Arms, 5mm,
cream. Tips for tremolo arms made
in Germany in the 60s + 70s. Made
from a kind of bakelite. 14x34mm



TAC6K
Retro Tip for Tremolo Arms, 6mm,
cream. Tips for tremolo arms made
in Germany in the 60s + 70s. Made
from a kind of bakelite. 11 x 41mm



TAC6B
Retro Tip for Tremolo Arms, 6mm,
black. Tips for tremolo arms made
in Germany in the 60s + 70s. Made
from a kind of bakelite. 11 x 41mm



TAC7K
Retro Tip for Tremolo Arms, 6mm,
cream. Tips for tremolo arms made
in Germany in the 60s + 70s. Made
from a kind of bakelite. 14 x 34mm.



TM13A
Tips (cover) for Tremolo Arm. 5mm,
aged white (a little more light than the
cream cover!).



TM13B
Tips (cover) for Tremolo Arm. 5mm,
black.



TM13K
Tips (cover) for Tremolo Arm. 5mm,
vintage aged.



TM13W
Tips (cover) for Tremolo Arm. 5mm, white.



TM20P
Tip for Maestro Style Tremolo Arm. Plastic tip for tremolo arms like Göldo TM21N. Length 7.5cm, bore diameter 6mm. semi-transparent ivory.

Supplies



S70LN
Spring for Bigsby-Style Tremolos, long, nickel. 27.5mm x 18mmØ x 2.2mm.



S70LG
Spring for Bigsby-Style Tremolos, long, gold. 27.5mm x 18mmØ x 2.2mm.



S70SC
Spring for Duesenberg Tremolos, short, nickel. 22mm x 19mmØ x 2,6mm.



S70SG
Spring for Bigsby-Style Tremolos, short, gold. 22mm x 19mmØ x 2,6mm.



TM10F
Tremolo Spring, standard soft, 6 pieces



TM14F
Tremolo Spring, extra hard, 6 pieces



SR00C
Tremolo Bearing Screws for Strat, nickel (30 pcs.), 3.5 x 30 mm



SR00B
Tremolo Bearing Screws for Strat, black (30 pcs.), 3.5 x 30 mm



SR00G
Tremolo Bearing Screws for Strat, gold (30 pcs.), 3.5 x 30 mm



TGDDH
The Downholder, nickel. Mounted 1:1 in the existing mounting holes of the Stop tailpiece, allows the install. of a larger trem system.



TMSPH
Spring Mounting Claw



TM51P
Allen Key Holder for tremolos, 5pcs. Matching most tremolo or guitar bridge Allen screws (1.5, 2, 2.5, 3 und 4 mm). Held by a small magnetic plate.



TB00S
Tremolo Steel Block. Should fit all vintage replica tremolos. A good investment for Sound!



TM060
Back Box. Invisible zero point for all spring-cavity tremolos. Keeps the tremolo back in a certain adjustable position. Raising the tremolo arm moves the spring back.

GOTOH

Arms



TM17B

Tremolo Arm for Gotoh Floyd Rose, black. Plugin arm for the Gotoh Floyd Rose GE1988T (which is not produced any more). Ø5.5mm.



TM19C

Threaded Arm for Gotoh Tremolos, chrome. Fits the Gotoh Floyd Rose GE1996T (Göldo article no. TF40C), with inside thread.



TM19B

Threaded Arm for Gotoh Tremolos, black. Fits the Gotoh Floyd Rose GE1996T (Göldo article no. TF40B), with inside thread.



TM55N

Tremolo Arm for Wilkinson, Steel Plug-in arm for Wilkinson Vintage with white tip, 5 mm.

Supplies



TF4SC

Gotoh Floyd Rose Studs, chrome. Replacement studs for Gotoh tremolo TF40C. Incl. Bushings.



TF4SB

Gotoh Floyd Rose Studs, black. Replacement studs for Gotoh tremolo TF40B. Incl. Bushings.



TM50P

Gotoh Allen Key Holder, incl. 4 Allen keys. For almost all Floyd Screws.

Schaller

Arms



SC-20010101

Tremolo arm (LockMeister, Schaller, Vintage), nickel. Complete with arm coupling kit and socket. Left: SC-20010102



SC-20010201
Chrome
Left:
SC-20010202



SC-20010501
Gold
Left:
SC-20010502



SC-20010301
Satin Chrome
Left:
SC-20010302



SC-20010601
Ruthenium
Left:
SC-20010602



SC-20010401
Black Chrome
Left:
SC-20010402

Baseplate



SC-20280106

Tremolo baseplate (LockMeister 6, Schaller), nickel. With 6 fine tuning screws M5x8 & 6 saddle mounting screws M3x8.



Chrome
SC-20280206



Satin Chrome
SC-20280306



Black Chrome
SC-20280406



Gold
SC-20280506



Ruthenium
SC-20280606



SC-20280116

Tremolo baseplate (LockMeister 6, Schaller) LEFT, nickel. With 6 fine tuning screws M5x8 & 6 saddle mounting screws M3x8.



Chrome
SC-20280216



Satin Chrome
SC-20280316



Black Chrome
SC-20280416



Gold
SC-20280516







Ruthenium
SC-20280616



SC-20280107

Tremolo baseplate (LockMeister 7, Schaller), nickel. With 7 fine tuning screws M5x8 & 7 saddle mounting screws M3x8

-  Chrome
SC-20280207
-  Satin Chrome
SC-20280307
-  Black Chrome
SC-20280407
-  Gold
SC-20280507
-  Ruthenium
SC-20280607



SC-20280100

Tremolo baseplate (Schaller, LockMeister 6), nickel. With 6 fine tuning screws M5x8 & 6 saddle mounting screws M3x8

-  Chrome
SC-20280200
-  Satin Chrome
SC-20280300
-  Black Chrome
SC-20280400
-  Gold
SC-20280500
-  Ruthenium
SC-20280600

Saddle



SC-20060106

Saddles (LockMeister 6, Schaller), nickel, 6pcs. With string locking screws M4x40, insert blocks 4x4 and saddle mounting screws M3x8.

-  Chrome
SC-20060206
-  Satin Chrome
SC-20060306
-  Black Chrome
SC-20060406
-  Gold
SC-20060506
-  Ruthenium
SC-20060606

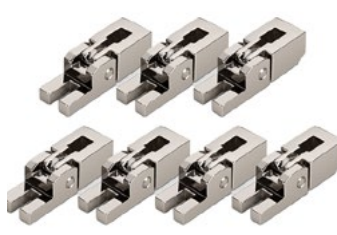

SC-20060107

Saddles (LockMeister 7, Schaller), nickel, 7pcs. With string locking screws M4x40, insert blocks 4x4 and saddle mounting screws M3x8.

-  Chrome
SC-20060207
-  Satin Chrome
SC-20060307
-  Black Chrome
SC-20060407
-  Gold
SC-20060507
-  Ruthenium
SC-20060607

Tremolo Block



SC-20150132

Tremolo block (LockMeister, Schaller), 32mm, nickel. 1 Tremolo block with shim, bronze spring and 3 mounting screws M5x12 for tremolo block.

37mm: **SC-20150137**

42mm: **SC-20150142**



SC-20450132

Tremolo block (Tremolo 2000, Vintage), 32mm, nickel. 1 Tremolo block with 3 mounting screws M5x12 for tremolo block.

37mm: **SC-20450137**

42mm: **SC-20450142**

Tremolo Claw



SC-13140100

SureClaw, nickel. For guitarists who use a tremolo system with sustain block. It helps maintain the correct spring tension who can be adjusted without removing the back cover plate.



SC-20170100

Tremolo claw (LockMeister, Schaller), nickel. 1 Tremolo claw with mounting screws M4,2x45 (for LockMeister 6+7, Schaller, Vintage-Tremolo)



SC-20170106





Tremolo springs, 3pcs. For LockMeister 6+7, Schaller, Vintage-Tremolo

String-
retainer



SC-20190100

Tremolo Stringretainer, nickel. For 6-Strings, with mounting screws M2,2x16



	Chrome SC-20190200
	Satin Chrome SC-20190300
	Black Chrome SC-20190400
	Gold SC-20190500
	Ruthenium SC-20190600

Studs &
inserts



SC-20120100

Studs and inserts (LockMeister, Schaller, Vintage, 2000), nickel, 2pcs. With threaded bushings (metric)

	Chrome SC-20120200
	Satin Chrome SC-20120300
	Black Chrome SC-20120400
	Gold SC-20120500
	Ruthenium SC-20120600

BRIDGE & TAILPIECES





Gibson-Style Bridges



HWD3C

3-Point Radius Bridge, chrome. The 3rd gen. of the tuneomatic style bridge. Defined, direct vibration transmission without significant loss of vibration energy.



HWD3G

3-Point Radius Bridge, gold. The 3rd gen. of the tuneomatic style bridge. Defined, direct vibration transmission without significant loss of vibration energy.



HWD3N

3-Point Radius Bridge, nickel. The 3rd gen. of the tuneomatic style bridge. Defined, direct vibration transmission without significant loss of vibration energy.



HWDPN

Piezo Bridge, nickel. Now identical to the Duesenberg Steel Saddle Bridge HWD2N, but 1.5mm higher. String spacing 52mm, post spacing 73,5mm.



HWD12C

12-String Bridge, chrome. 12 individual saddles for perfect intonation. M4 posts. String spacing 52 mm (outer strings), post spacing 73,5 mm.



HWD12N

12-String Bridge, nickel. 12 individual saddles for perfect intonation. M4 posts. String spacing 52 mm (outer strings), post spacing 73,5 mm.



HWD12G

12-String Bridge, gold. 12 individual saddles for perfect intonation. M4 posts. String spacing 52 mm (outer strings), post spacing 73,5 mm.



HW01C

Wrap Around Bridge (81.5 mm), chrome. Great sound, incredible attack! Stud spacing 81.5mm, string spacing 52mm radius 14"



HW01G

Wrap Around Bridge (81.5 mm), gold. Great sound, incredible attack! Stud spacing 81.5mm, string spacing 52mm radius 14"



HW01N

Wrap Around Bridge (81.5 mm), nickel. Great sound, incredible attack! Stud spacing 81.5mm, string spacing 52mm radius 14"



HW06G

Wrap Around Bridge (73.5 mm), gold. Can replace a standard Tuneomatic bridge. Stud spacing: 73.5mm. String spacing 52mm, radius 14"



HW06N

Wrap Around Bridge (73.5 mm), nickel. Can replace a standard Tuneomatic bridge. Stud spacing: 73.5mm. String spacing 52mm, radius 14"

Tailpieces for Solid-Body



HW10A

Stop Tailpiece "light", nickel. The better sound because aluminum is used instead of zinc! Post spacing 81.5mm.



HW1AB

Stop Tailpiece "light", black. Better sound because aluminum is used instead of zinc! Post spacing 81.5mm.



HW1AG

Stop Tailpiece "light", gold. Better sound because aluminum is used instead of zinc! Post spacing 81.5mm.



HW75N

3-Step Tailpiece, nickel. For archtop and semi-acoustic guitars. Two small screws are included to mount the tailpiece to the body, and one SR01C screw for the strap pin if needed.

Bass Bridges

**HWBBN**

Trapeze Tailpiece for Bass, nickel. Tailpieces for semiacoustic basses, like Duesenberg Starplayer- and Violin-Bass.

**HWTBN**

Triton Bass Bridge, nickel. Solid aluminum base & sintered high-grade steel saddles. A fat sound with a lot of sustain. 83x50mm, string spacing 57mm

Fender

Bridges for Strat

**005-8274-000**

Hardtail Strat® Bridge Assembly (Import), chrome. With 6 block saddles, intonation screws, springs and saddle-height adjustment screws.

**005-4619-000**

Vintage-Style Strat® Bridge Assemblies, chrome. Use with U.S.- and Mexico-made Strat including Classic Series from 2004-present & Highway One from before 2006.

**005-3275-000**

Vintage-Style Strat® Bridge Assemblies, gold. Use with U.S.- and Mexico-made Strat including Classic Series from 2004-present & Highway One from before 2006.

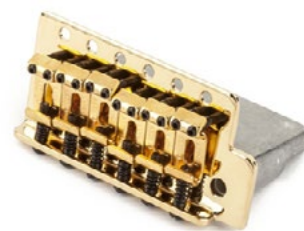
**005-9561-000**

Vintage-Style Standard Series Strat Bridge (Pre '06), gold. Use with most Standard series Stratocaster models manufactured before 2006.

**006-0068-000**

6-Saddle Hardtail Classic/Standard Series Bridge Assembly, chrome. For Classic and Pawn Shop series instruments

**007-1014-049**

Vintage-Style Standard Series Strat Tremolo Assemblies, chrome. Use on Strd, Deluxe, Roadhouse, LoneStar + Blacktop Strat from 2006-present.

**007-1016-000**

Vintage-Style Strd Series Strat Tremolo Assemblies LEFT, chrome. Use on Strd, Deluxe, Roadhouse, LoneStar + Blacktop Strat from 2006-present.

**003-2909-049**

Bridge Assembly, American Standard Strat '86-'07 NON-TREMOLO, chrome.

**099-2051-000**

American Vintage Strat Bridge Saddles (6pcs), chrome. Use on American Vintage series Strat models manufactured from 1986-present.

**099-2091-000**

Pure Vintage Strat Pat. Pend. Saddle Kit, nickel. Crafted where possible on the same tooling and machinery as our original-era Fender parts.

**099-0840-000**

American Series ('86-'07) Strat Saddle Assemblies, steel. Use on American and American Standard series guitars from 1986-2007.

**003-6528-000**

American Deluxe Strat® Saddle, steel. Used on most American Deluxe Strat® models produced from '86-Present (Will NOT work with vintage or American Standard bridges)

Bridges for Tele



006-0070-000

Highway One Tele Bridge Assembly. Chrome-plated string-through-body bridge assembly for use on Highway One series Telecaster guitars.



099-0810-000

6-Saddle Vintage-Style Tele Bridge Assembly, nickel. Use on American Vintage series and Deluxe Nashville Telecaster guitars.



099-0806-100

3-Saddle Vintage-Style Tele Bridge Assembly, chrome. Use on vintage-style Telecaster guitars manufactured from 1986-present.



099-0807-100

6-Saddle American Series Tele Bridge Assemblies. Modern six-saddle. Use on American, American Deluxe and American Standard series Telecaster guitars from 1986-2007

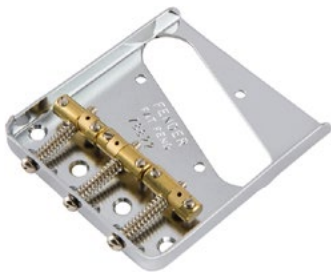

009-1114-049

3-Saddle American Vintage Hot Rod Tele Bridge Assembly, nickel. Use on American Vintage Hot Rod Tele (also retrofits on American Vintage series Tele).



099-0843-000

Pure Vintage '52 Tele Saddle Kit, nickel. Fits most vintage-style three-saddle Telecaster bridges; will not fit modern six-saddle Telecaster bridges.



099-2089-000

Pure Vintage '58 Tele Saddle Kit, nickel. Fits most vintage & modern Tele with vintage 3-saddle bridge design; will NOT fit modern 6-saddle bridges.



099-2090-000

Pure Vintage '64 Tele Saddle Kit, nickel. Fits most vintage & modern Tele with vintage 3-saddle bridge design; will NOT fit modern 6-saddle bridges.

Bridges for Jazz Bass



005-6038-049

American Vintage Tele Threaded Bridge Saddles, nickel, 3pces. For American Vintage series Telecaster models.



005-8544-049

American Vintage Tele Compensated Bridge Saddles, 3pces. For vintage-style three-saddle Telecaster bridge assemblies.



005-5257-049

Pure Vintage '70s Jazz Bass Bridge Assembly, chrome. Fits most vintage and modern Jazz Bass models with five-screw bridge mounting.



005-8396-000

American Deluxe 4-String Bass Bridge Assemblies ('04-'10), chrome. For American Deluxe bass models (2004-2010)

Bridges for Jazz & Precision Bass

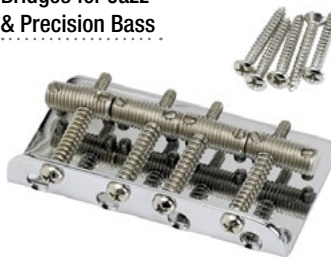

099-0804-100

Vintage-Style Bass Bridge Assembly, Nickel. Fits most vintage and modern Precision Bass® and Jazz Bass® guitars with a five-screw mounting design

Bridges for Other Guitars



003-5555-000

Mustang Guitar Bridge Assembly (Japan), Chrome. For Classic series '65 Mustang & Jag-Stang models (2006-present). 2-7/8" bridge spacing

Supplies



001-9394-049

American Deluxe-American Series Strat Intonation Springs, Tall. Used on American Deluxe (1986-present), Am. series & Standard (1986-2007) Strat tremolo + non-tremolo bridge.



001-9273-049

American Vintage Strat. Intonation Springs. Fits American Vintage, Road Worn®, Classic Player, and Classic Series Strat guitar bridge assemblies (1986-Present)

Ferrules



099-4917-000

American Standard Tele String Ferrules, set of 6, chrome. For American and American Standard series string-through-body Telecaster models.



001-8876-049

Vintage-Style Tele String Ferrules, set of 6, gold. For American Vintage and Classic series string-through-body Telecaster models.



099-4918-000

Vintage-Style Tele String Ferrules, set of 6, chrome. For American Vintage and Classic series string-through-body Telecaster models.



004-8604-049

Bass String Ferrules, set of 4, steel. For string-through-body American Deluxe, American Standard and American series basses (1998-present).

golds

Gibson-Style Bridges



HW05C

«Turnomatic» Rollerbridge, chrome. Equipped with small rollers. Perfect for guitars with tremolo. M4. For 14" fing. radius. String spacing 52 mm.



HW05G

«Turnomatic» Rollerbridge, gold. Equipped with small rollers. Perfect for guitars with tremolo. M4. For 14" fing. radius. String spacing 52 mm.



HW05N

«Turnomatic» Rollerbridge, nickel. Equipped with small rollers. Perfect for guitars with tremolo. M4. For 14" fing. radius. String spacing 52 mm.



HW155

Jazz Guitar Bridge, ebony. Has a compensated massiv wooden top. String spacing from 49 to 52mm. 135.5x15x24.5mm

Tailpieces for Solid-Body



HWBLN

Lapsteel Bridge, nickel. Solid straight bridge, fixed directly to the guitar top with 3 screws. Size: 70x10x10mm, string spacing: 52mm.



HWR1C

Ricky Bridge, chrome. Stands on the base plate with its four M3 Allen screws. Screwed to the guitar's top. String spacing 50 mm.



HWL6N

Tailpiece, 6-string, nickel. Solid tailpiece for solidbody guitars with a flat top. Suitable for lapsteel. 6-string. 71x20x10mm, string spacing: 52mm.



HWL12N

Tailpiece, 12-string, nickel. Solid tailpiece for solidbody guitars with a flat top. 12-string. Size: 71x20x10mm, string spacing: 55mm (outer strings).

Tailpieces for Jazz Guitar & ES



H12SC

12-String Stop Tailpiece, chrome. Like a standard stop tailpiece but with 12 holes.



HW70C

Trapeze Tailpiece, chrome. For ES and jazz guitars.



HW70G

Trapeze Tailpiece, gold. For ES and jazz guitars.



HW70N

Trapeze Tailpiece, nickel. For ES and jazz guitars.

**HW78G**

Tailpiece «Garden Door», gold.
For ES and jazz guitars.

**HWJDG**

Jazz Tailpiece «6-Finger» Deluxe,
gold. The angle of each of the 6
tailpiece «fingers» can be adjusted
individually. Length 16.5cm.

**HWJDN**

Jazz Tailpiece «6-Finger» Deluxe,
nickel. The angle of each of the 6
tailpiece «fingers» can be adjusted
individually. Length 16.5cm.

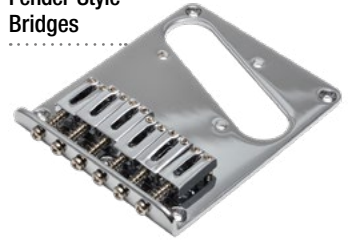
**Fender-Style
Bridges**
**HW48C**

Steel Bridge for Tele, chrome, single
coil. Suitable for the standard Tele.
Note: this bridge does not fit on Göldo
bodies with correct vintage routings.

**HW49C**

Steel Bridge for Tele, chrome, for
humbucker. Designed for a humbuc-
ker bridge position. Larger base plate:
101 x 89 mm. Stringspacing 54mm

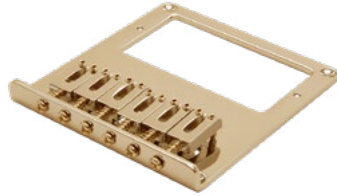
**HW49G**

Steel Bridge for Tele, gold, for
humbucker. Designed for a humbuc-
ker bridge position. Larger base plate:
101 x 89 mm. Stringspacing 54mm

**HWJ1C**

Bridge for Jazzmaster, chrome
Moves slightly on the posts, when the
tremolo is used.

**HWPRC**

Guitar Bridge «Xtra Heavy», chrome.
For flat guitar bodies. Heavy base-
plate & solid string saddles, never
ending sustain! Stringspacing 54mm.

**HWPRB**

Guitar Bridge «Xtra Heavy», black.
For flat guitar bodies. Heavy base-
plate & solid string saddles, never
ending sustain! Stringspacing 54mm.

**HWPRG**

Guitar Bridge «Xtra Heavy», gold.
For flat guitar bodies. Heavy base-
plate & solid string saddles, never
ending sustain! Stringspacing 54mm.

**HWTM**

«Cut-off» Bridge for Tele, chrome.
With compensated brass saddles
for exact intonation. Stringspacing
54mm.

**GTC12C**

12-String Bridge, chrome.
Finest mechanical construction!

**7-String
Bridges**
**HW17B**

7-String Bridge for Strat, black.
String spacing 64mm. Screws
included.

**HW17C**

7-String Bridge for Strat, chrome.
String spacing 64mm. Screws
included.

**HW27B**

7-string Tunomatic Bridge, black.
With M8 posts. String spacing 62
mm, post spacing 83,5 mm.

**HW27C**

7-string Tunomatic Bridge, chrome.
With M8 posts. String spacing 62
mm, post spacing 83,5 mm.

Bass Bridges



HW37C

7-string Stop Tailpiece, chrome. Including studs and nuts, M8!



HW50C

3-D Bass Bridge, 4-String, chrome, single coil. Diecasted like a Badass bridge. Steel lockable saddle. Great sound! String spacing 19mm.



HW50B

3-D Bass Bridge, 4-String, black, single coil. Diecasted like a Badass bridge. Steel lockable saddle. Great sound! String spacing 19mm.



HW50G

3-D Bass Bridge, 4-String, gold, single coil. Diecasted like a Badass bridge. Steel lockable saddle. Great sound! String spacing 19mm.



HW55C

3-D Bass Bridge, 5-String, chrome, single coil. Diecasted like a Badass bridge. Steel lockable saddle. Great sound! String spacing 16.8mm.



HW55B

3-D Bass Bridge, 5-String, black, single coil. Diecasted like a Badass bridge. Steel lockable saddle. Great sound! String spacing 16.8mm.

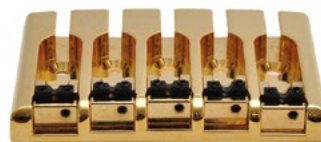

HW55G

3-D Bass Bridge, 5-String, gold, single coil. Diecasted like a Badass bridge. Steel lockable saddle. Great sound! String spacing 16.8mm.



HW60C

Bass Bridge 1-string Unit, chrome. Housing made of zinc, brass saddles. Dimensions 60mm x 15.4mm, string spacing at the bridge min. 15.5mm.



HW60B

Bass Bridge 1-string Unit, black. Housing made of zinc, brass saddles. Dimensions 60mm x 15.4mm, string spacing at the bridge min. 15.5mm.



HW60G

Bass Bridge 1-string Unit, gold. Housing made of zinc, brass saddles. Dimensions 60mm x 15.4mm, string spacing at the bridge min. 15.5mm.



HW80C

Standard Bass Bridge, 4-string, chrome. Top quality! 60mm string spacing.



HW80B

Standard Bass Bridge, 4-string, black. Top quality! 60mm string spacing.

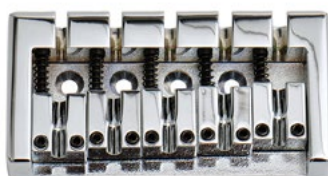

HW85C

Standard Bass Bridge, 5-string, chrome. Top quality! 68mm string spacing.



HW85B

Standard Bass Bridge, 5-string, black. Top quality! 68mm string spacing.



HWM4C

MM Style Bass Bridge, chrome. The big bridge with steel base plate and brass saddles, 4-string.

Supplies



HW11A

Conversion Post M4/M8, 1 pair, nickel. Allows the installation of a vintage Tunomatic bridge in M8 bushings.



HW12C
Bridge Saddles for Tunomatic, nickel. 6 pcs, including screws



HW12G
Bridge Saddles for Tunomatic, gold. 6 pcs, including screws



HW150
Ebony base for Tunomatic, for Tunomatic bridges on Jazz guitars.



HW25B
Allen Screws for Tunomatic, 1 pair, nickel. For the height adjust. wheels of the bridge. M4 x 25mm. Easy to turn into the body by an allen wrench.



HW2RN
Thumb Wheels for Tunomatic, M4, 1 pair, nickel. For Tunomatic bridges on jazz-guitars, studs not included.



HW47C
Body-Top string ferrules, chrome. For the body top outlet - if you want to use a Tunomatic bridge & put strings from the back through the body.



HW47N
Body-Top string ferrules, nickel. For the body top outlet - if you want to use a Tunomatic bridge & put strings from the back through the body.



HW47B
Body-Top string ferrules, black. For the body top outlet - if you want to use a Tunomatic bridge & put the strings from the back through the body.



HW47G
Body-Top string ferrules, gold. For the body top outlet - if you want to use a Tunomatic bridge & put the strings from the back through the body.



HW4RN
Tunomatic Height Adjuster Wheels, 1pc nickel. Instead of turning the knurls, take a 2mm allen wrench from top. Bushings Ø6mm, 11mm long.



HW4RG
Tunomatic Height Adjuster Wheels, 1 pair, gold. Instead of turning the knurls, take a 2mm allen wrench from top. Bushings Ø6mm, 11mm long.



HW4DBK
Universal Base Kit for Tunomatic, rosewood. For Tunomatic bridge installation on jazz guitars. Suitable for 73.5 and 89.5mm stud spacing.



HW45C
String Bushings, 6 pcs., 8mm, nickel. For Tele and non-tremolo Strats



HW45B
String Bushings, 6 pcs., 8mm, black. For Tele and non-tremolo Strats



HW45G
String Bushings, 6 pcs., 8mm, gold. For Tele and non-tremolo Strats



HW46C
String Ferrules "49", 6 pcs., 9,5mm, nickel. For Tele and non-tremolo Strats

**TV12C**

Saddles for Strat, chrome.
Humbucker spacing, 10.5mm,
molded, 6 pieces.

**TV12B**

Saddles for Strat, black.
Humbucker spacing, 10.5mm,
molded, 6 pieces.

**TV12G**

Saddles for Strat, gold.
Humbucker spacing, 10.5mm,
molded, 6 pieces.

**TV13N**

Vintage Saddles for Strat, nickel,
10,8mm, M3 metric screws.

**TV13V**

Vintage Saddles for Strat, antique
nickel, 10,8mm, M3 metric screws.

**TV14C**

Vintage Saddles f. Strat, nickel.
Set of 6, including screws & springs.
11,3mm, US screws and allens.

**TV15C**

Steel Saddles, chrome. Steel saddles
for Fender-style bridges, 10.8mm, 6
pieces.

GOTOH®

Gibson-Style
Bridges

**GRBTM**

Relic Tune-O-Matic Bridge, aged
nickel. Hard zinc. String spacing
10.4mm. Best GOTOH quality in a
stylish relic design.

Tailpieces for
Solid-Body

**GRSTP**

Relic Stop-Tailpiece, aged nickel.
Made of solid aluminum. Inkl. studs
and bushings. Best GOTOH quality in
a stylish relic design.

Fender-Style
Bridges

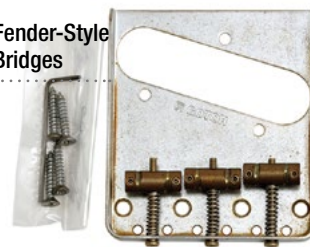
**GRBTL**

Relic Bridge Telly, aged chrome.
The classic Telly Bridge with three
compensated brass saddles. String
spacing 10.8mm. Stylish relic design.

Supplies

**VS10C**

Saddle Sets for Wilkinson VS100,
Set of 6, satin-chrome

**VS10B**

Saddle Sets for Wilkinson VS100,
Set of 6, black

**VS10G**

Saddle Sets for Wilkinson VS100,
Set of 6, satin-gold

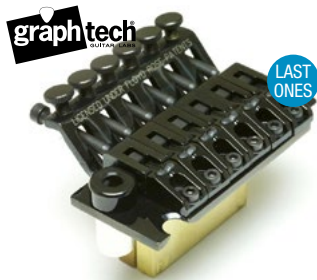

LAST ONES

PN-0080-B0

GHOST LB63 FLOYD ROSE Style Bridge w/Piezo Pickup Saddles - black. Ghost loaded replacement for a Floyd Rose Original & Licensed bridge.



LAST ONES

PS-0080-B0

Stringsaver, Floyd Rose Bridge with SS Inserts, black. Drop-in replt for Floyd Rose Original & Licensed bridges loaded with String Saver inserts.

KLUSON

Gibson-Style Bridges



HW13C

Vintage Tunamatic, chrome. Classic With retainer wire & M4 posts. For 14" fingerboard radius. String spacing 52 mm, stud spacing 73,5 mm.



HW13N

Vintage Tunamatic, nickel. Classic With retainer wire & M4 posts. For 14" fingerboard radius. String spacing 52 mm, stud spacing 73,5 mm.



HW18C

Vintage Bridge, M8, chrome. Tunamatic bridge with M8 studs. String spacing 52 mm, stud spacing 73.5 mm.

Wrap-around bridges



HW02C

One-Piece Bridge, chrome. Post spacing 81.5mm, string spacing 52mm, radius 14". Best sound for little money!



HW02G

One-Piece Bridge, gold. Post spacing 81.5mm, string spacing 52mm, radius 14". Best sound for little money!



HWW1C

Wrap Around Alu-Bridge, chrome. Only the saddle for B & G strings is adjustable. Stud spacing 81.5mm, string spacing 52mm, radius 14".



HWW1G

Wrap Around Alu-Bridge, gold. Only the saddle for B & G strings is adjustable. Stud spacing 81.5mm, string spacing 52mm, radius 14".



HW10C

Stop Tailpiece Bridge, chrome. Post spacing 81.5mm.

Tailpieces for Solid-Body



HW10B

Stop Tailpiece Bridge, black. Post spacing 81.5mm.



HW10G

Stop Tailpiece Bridge, gold. Post spacing 81.5mm.

Fender-Style bridges



HW15C

Vintage Bridge for Strat, chrome/nickel. Vintage-Style bridge, pressed steel saddles. String spacing 54mm. Comes without string bushings HW45



HW15B

Vintage Bridge for Strat, black chrome. Vintage-Style bridge, pressed steel saddles. String spacing 54mm. Comes without string bushings HW45

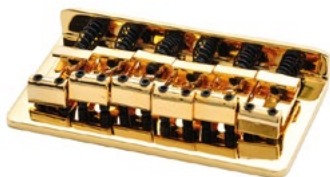
**HW15G**

Vintage Bridge for Strat, gold. Vintage-Style bridge, pressed steel saddles. String spacing 54mm. Comes without string bushings HW45

**HW16C**

Top Mount Bridge, chrome. Modern one-piece bridge, string saddles are securely fixed in position. 75x42mm, string spacing 56mm.

**HW16B**

Top Mount Bridge, black. Modern one-piece bridge, string saddles are securely fixed in position. 75x42mm, string spacing 56mm.

**HW16G**

Top Mount Bridge, gold. Modern one-piece bridge, string saddles are securely fixed in position. 75x42mm, string spacing 56mm.

**HW40C**

Bridge for Tele, chrome. Modern bridge with solid, 3 mm thick brass plate and six rectangular brass string saddles. Stringspacing 54mm.

**HW40G**

Bridge for Tele, gold. Modern bridge with solid, 3 mm thick brass plate and six rectangular brass string saddles. Stringspacing 54mm.

**HW42C**

Six Saddles Bridge, chrome. Vintage housing with six cylindrical saddles. Stringspacing 54mm.

**HW4TC**

Vintage Style Bridge, chrome. Classic design with three brass saddles and a pressed steel base-plate. Stringspacing 54mm.

Bass Bridge

**HW20C**

Vintage Bass Bridge, chrome. Replica of the old P- and J-Bass bridge with saddles made of threaded bolts. Now with hex screws.

KTS
 Gibson-Style
 Bridges
**KTS01C**

Tunomatic Titanium Bridge, ABR-1 Style, chrome. Longer sustain, clearer note separation, improved harmonic response, weight relief!

**KTS01G**

Tunomatic Titanium Bridge, ABR-1 Style, gold. Longer sustain, clearer note separation, improved harmonic response, weight relief!

**KTS06C**

Tunomatic Bridge, Nashville Style, chrome. Longer sustain, clearer note separation, improved harmonic response, weight relief!

**KTS06G**

Tunomatic Bridge, Nashville Style, gold. Longer sustain, clearer note separation, improved harmonic response, weight relief!

Bass Bridges

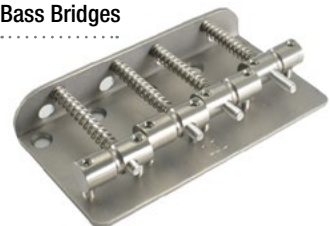
**KTS03SET**

Vintage Bass Bridge with Titanium Saddles, plain saddles. Longer sustain, clearer note separation, improved harmonic response, weight relief!

**KTS03SP**

Titan Saddles for Vintage Bass Bridges, threaded. Longer sustain, clearer note separation, improved harmonic response, weight relief!

**KTS03T**

Titanium Saddles for Vintage Bass Bridges, plain. Longer sustain, clearer note separation, improved harmonic response, weight relief!

Supplies

**KTSPR01**

Tunomatic Titanium Saddles, jap. ABR-1 Style. For Japanese ABR-1 style bridges (made by TOKIWA). With string groove. Thread M3.

**KTSPR02**

Tunomatic Titanium Saddles, for Gibson ABR-1. No string groove. Thread 4/40 (inch).

**KTSPR05**

Tunomatic Titanium Saddles, for GOTOH GE103/GE104 bridges. No string groove. Thread M2.6.

**KTSPR06**

Tunomatic Titanium Saddles, for original Gibson Nashville T-O-M bridges. No string groove. Thread M3.

**KTS08Q**

Titanium Saddles for Tele, for Vintage Telecasters made in the late 60ies. With 6/32 screws and springs. Diameter is 6.5mm / 0.25".

**KTS08T**

Titanium Saddles for Tele, barrel style. Fits vintage Telecasters made in USA or Japan. With M3 screws & springs. Diam. of the «barrel» is 8mm.

**KTS08W**

Titanium Saddles for Tele, compensated. With 6/32 screws and springs. Diameter 8mm. No string grooves.

**KTSPR04**

Titan Saddles for jap. Vintage Tremolos. For Japanese F-Style vintage tremolos (GOTOH etc.). M3 screws + springs. Stringspacing 54mm

**KTSPR11**

Titan Saddles for US Vintage Tremolos. For USA or Mexico made vintage tremolos. With 4/40 screws & springs. Stringspacing 56.5mm.

**KTSPR14**

Titan Saddles for PRS Vintage Tremolos. For PRS & many Asia made vintage tremolos. With 4/40 screws + springs. Stringspacing 52.4mm.

**KTSPR15**

Titan Saddles for Vintage Tremolos, offset type. For US made Standard Strat Strat Plus. With 4/40 screws and springs. Stringspacing 52.4mm.

**KTSPR17**

Titan Saddles for modern Vintage Tremolos. For GOTOH 510, GE1088, 1089 etc. With screws and springs. Stringspacing 54mm.

**KTSPR18**

Titan Saddles for Vintage Tremolos, offset type. For GOTOH 510, GE1088, 1089 etc. With screws and springs. Stringspacing 54mm.

**KTSPRMU**

Titan Saddles for Mustang Style Bridges, offset type. For Mustang, Jaguar or Jazz Master.

sandberg 

Bass Bridges



HWS4C

Bass Bridge, 4-string, chrome. Strings hooked in from the top. Action, intonation & string spacing are fixed with small Allen screws.



HWS4B

Bass Bridge, 4-string, black. Strings hooked in from the top. Action, intonation & string spacing are fixed with small Allen screws.



HWS4G

Bass Bridge, 4-string, gold. Strings hooked in from the top. Action, intonation & string spacing are fixed with small Allen screws.



HWS5C

Bass Bridge, 5-string, chrome. Strings hooked in from the top. Action, intonation & string spacing are fixed with small Allen screws.



HWS5B

Bass Bridge, 5-string, black. Strings hooked in from the top. Action, intonation & string spacing are fixed with small Allen screws.



HWS5G

Bass Bridge, 5-string, gold. Strings hooked in from the top. Action, intonation & string spacing are fixed with small Allen screws.

Schaller



SC-SIG-NI

Signum, nickel. Iconic bridge designed to boost your guitars sound, playability and looks.

Please choose type of studs & inserts INCLUDED



SC-SIG-CH
Chrome



SC-SIG-GO
Gold



SC-SIG-BC
Black Chrome



SC-SIG-RU
Ruthenium



SC-HAN6-NI

Hannes, 6-String, nickel. A splendid fusion of innovation and tone in top quality - straightforward and noble.



SC-HAN6-CH
Chrome



SC-HAN6-GO
Gold



SC-HAN6-BC
Black Chrome



SC-HAN6-RU
Ruthenium



SC-STM-NI

STM, nickel. High-quality roller bridge for all Les Paul™ type guitars. Compatible with post spacings from 74.0 - 74.5mm.

Please choose type of studs & inserts INCLUDED



SC-STM-CH
Chrome



SC-STM-GO
Gold



SC-STM-BC
Black Chrome



SC-STM-RU
Ruthenium



SC-GTM-KTS-NI

GTM by KTS, nickel. High-quality Tunomatic bridge for all Les Paul type guitars. With titanium saddles - very light, durable, resistant to corrosion.

GTM Standard: **SC-GTM-NI**



SC-GTM-KTS-CH
Chrome
GTM Standard:
SC-GTM-CH



SC-GTM-KTS-GO
Gold
GTM Standard:
SC-GTM-GO



SC-GTM-KTS-BC
Black Chrome
GTM Standard:
SC-GTM-BC



SC-GTM-KTS-RU
Ruthenium
GTM Standard:
SC-GTM-RU



SC-3D-6-NI

3D-6, nickel. Flatmount bridge with adjustable height, intonation and string spacing (roller bridge saddles). Great intonation and tuning stability.



SC-3D-6-CH
Chrome



SC-3D-6-GO
Gold



SC-3D-6-BC
Black Chrome



SC-3D-6-RU
Ruthenium



SC-STTP-NI

Stop Tailpiece, nickel. For Schaller STM and GTM bridges. This tailpiece is usually built straight, i.e. parallel to the frets.



SC-STTP-CH
Chrome



SC-STTP-GO
Gold



SC-STTP-BC
Black Chrome



SC-STTP-RU
Ruthenium

Bass Bridges



SC-3D-4-NI

3D-4, nickel. Patented 4-string bass bridge, analog to 3D-6. Reliably minimize string breakage while maintaining intonation & tuning stability.

5-String: **SC-3D-5-NI**



SC-3D-4-CH
Chrome
5-String:
SC-3D-5-CH



SC-3D-4-GO
Gold
5-String:
SC-3D-5-GO



SC-3D-4-BC
Black Chrome
5-String:
SC-3D-5-BC



SC-3D-4-RU
Ruthenium
5-String:
SC-3D-5-RU

Supplies



SC-12260101

Underlays/Shims/Spacer 3D-6, nickel. Shim 3mm high

BASSES For 3D-4: **SC-12240101**
BASSES For 3D-5: **SC-12250101**



SC-12260201
Chrome
For 3D-4: **SC-12240201**
For 3D-5: **SC-12250201**



SC-12260501
Gold
For 3D-4: **SC-12240501**
For 3D-5: **SC-12250501**



SC-12260401
Black Chrome
For 3D-4: **SC-12240401**
For 3D-5: **SC-12250401**



SC-12260601
Ruthenium
For 3D-4: **SC-12240601**
For 3D-5: **SC-12250601**



SC-22012006

Signum saddles set of 6, gold. Saddles with screws and lock ring.



SC-22022006

GTM saddles set of 6, nickel. Saddles with screws & lock ring.

GTM by KTS, Titanium: **22392400**



SC-22040106

STM saddles set of 6, nickel. Saddles with screws & lock ring.

	Chrome SC-22040206
	Black Chrome SC-22040406
	Gold SC-22040506
	Ruthenium SC-22040606



SC-22070101

3D-6 - 1 saddle, for string G, B, E, nickel. With all screws and spring.

String E, A, D: **22070102**

	G, B, E: SC-22070201 E, A, D: SC-22070202
	G, B, E: SC-22070401 E, A, D: SC-22070402
	G, B, E: SC-22070501 E, A, D: SC-22070502
	G, B, E: SC-22070601 E, A, D: SC-22070602



Chrome	D: SC-22080201 G: SC-22080202	E: SC-22080203 A: SC-22080204
Black Chrome	D: SC-22080401 G: SC-22080402	E: SC-22080403 A: SC-22080404
Gold	D: SC-22080501 G: SC-22080502	E: SC-22080503 A: SC-22080504
Ruthenium	D: SC-22080601 G: SC-22080602	E: SC-22080603 A: SC-22080604

SC-22080101

3D-4 - 1 saddle, for string D, nickel. With all screws and spring.

String G: SC-22080102
String E: SC-22080103
String A: SC-22080104



Chrome	D: SC-22090201 G: SC-22090202	B+E: SC-22090203 A: SC-22090204
Black Chrome	D: SC-22090401 G: SC-22090402	B+E: SC-22090403 A: SC-22090404
Gold	D: SC-22090501 G: SC-22090502	B+E: SC-22090503 A: SC-22090504
Ruthenium	D: SC-22090601 G: SC-22090602	B+E: SC-22090603 A: SC-22090604

SC-22090101

3D-5 - 1 saddle, for string D, nickel. With all screws and spring.

String G: SC-22090102
String B+E: SC-22090103
String A: SC-22090104



Chrome	SC-22200200
Black Chrome	SC-22200400
Gold	SC-22200500
Ruthenium	SC-22200600

SC-22200100

Signum - pair of studs and inserts (metric), nickel. Pair of press-in bushings and height-adjustment screws with locking hex nut.



Chrome	SC-22210200
Black Chrome	SC-22210400
Gold	SC-22210500
Ruthenium	SC-22210600

SC-22210100

Stop tailpiece - pair of studs and inserts (metric), nickel. Pair of press-in bushings and height-adjustment screws.



Chrome	SC-22230200
Black Chrome	SC-22230400
Gold	SC-22230500
Ruthenium	SC-22230600

SC-22230100

STM - pair of studs and inserts (metric M5), nickel. Pair of press-in bushings and height-adjustment screws.



Chrome	SC-22240200
Black Chrome	SC-22240400
Gold	SC-22240500
Ruthenium	SC-22240600

SC-22240100

GTM + GTM Piezo - pair of studs and inserts (metric M5), nickel. Pair of press-in bushings and height-adjustment screws.

NUTS & SADDLES





NV41F

Shelf Nut, F-style 41mm, end with a slight offset for better intonation on the first frets



NV43F

Shelf Nut, F-style 43mm, end with a slight offset for better intonation on the first frets



NV41G

Shelf Nut, G-style 41mm, end with a slight offset for better intonation on the first frets



NV43G

Shelf Nut, G-style 43mm, end with a slight offset for better intonation on the first frets



099-4920-000

Nut, Strat/Tele Bone Nut (also for Left Hand) - blank (2 pieces)



099-4404-000

Nut, Melamine Strat/Tele Nut, Pre-Slotted, 9.5" Radius, 42.8mm wide



099-4405-000

Genuine bone Strat/Tele nut with vintage-specs. 7.25" fingerboard radius, Pre-Slotted, 9.5" Radius, 42.16mm wide



099-0812-000

Brushed-chrome LSR roller nut assembly. For string gauges .008 to .056. Right-hand instruments only.

Nuts for Bass



099-4921-000

Micarta string nut for American Standard Precision Bass, 9.5" top radius, 10" bottom radius, 42.03mm wide



004-8649-049

Set of 2 Micarta string nut for American Standard Precision Bass, 9.5" top, 7.25" bottom radius, 38.86mm wide

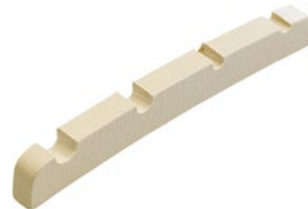

004-8650-000

Bone nut for American Standard Precision Bass, Slotted, 9.5" top, 7.25" bottom radius, 42.07mm wide



NR42C

Roller Nut, chrome, 3 rollers on a steel axle provide for frictionless tremolizing, 42.8x12mm



NR42B

Roller Nut, black, 3 rollers on a steel axle provide for frictionless tremolizing, 42.8x12mm



NR42G

Roller Nut, gold, 3 rollers on a steel axle provide for frictionless tremolizing, 42.8x12mm



NTVBG

Vintage Bone Nut, 55 x 10 x 6,5mm, Jumbo

Nuts for Bass



SNB42
DURO NUT BASS, 4-S,
42 x 6 x 9,4mm

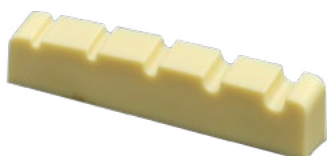

SNB45
DURO NUT BASS, 5-S,
45 x 6 x 10mm



SNFB40
DURO NUT BASS, 4-S,
40 x 3.4 x 5.7mm



SNFB42
DURO NUT BASS, 4-S,
42 x 3.4 x 5.5mm

Nuts for Fender guitar



SNF42
DURO NUT for Fender guitar, 6-S,
42 x 3.5 x 5.3mm



SNG42
DURO NUT for Gibson guitar, 6-S,
42 x 5 x 9mm



SNG44
DURO NUT for Gibson guitar, 6-S,
44 x 6 x 8mm

Nuts for Acoustic guitar



SNA12S
DURO NUT for Acoustic guitar,
12-S, 48 x 6 x 9,5mm



SNA42
DURO NUT for Acoustic guitar,
6-S, 42 x 6 x 9mm



SNA43
DURO NUT for Acoustic guitar,
6-S, 43 x 6 x 9,5mm



SNA44
DURO NUT for Acoustic guitar,
6-S, 43 x 5 x 9mm



SNA46
DURO NUT for Acoustic guitar,
6-S, 48 x 5 x 9,5mm



SNA52
DURO NUT for Acoustic guitar,
6-S, 52 x 6 x 9,3mm

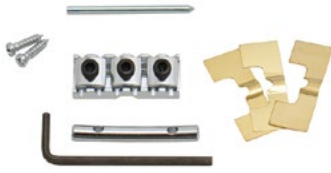

TM45C

Floyd Lock Nut, 41mm, chrome
No drilling through the neck! The nut is fastened from top by 2 screws

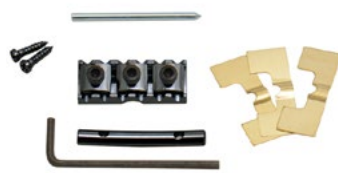

TM45B

Floyd Lock Nut, 41mm, black
No drilling through the neck! The nut is fastened from top by 2 screws

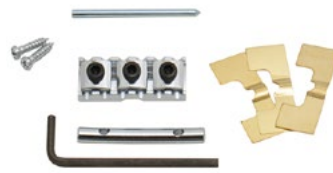

TM46C

Floyd Lock Nut, 43mm, chrome
No drilling through the neck! The nut is fastened from top by 2 screws

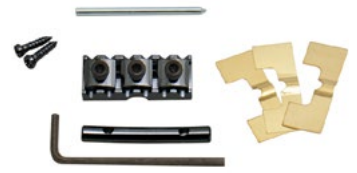

TM46B

Floyd Lock Nut, 43mm, black
No drilling through the neck! The nut is fastened from top by 2 screws



LAST ONES

PN-8200-00

GHOST Pickups Wilkinson Vs-100
(6pcs)

More products on our website
www.wharry.ch

Philippe Bosset



PBACC05

Nut made of bone SCULPTE for classical guitar (52 x 6 x 9 mm)



PBACC07

Nut made of bone SCULPTE for classical guitar (52 x 6 x 9 mm)



PBACC16

Nut made of bone for folk guitar (76 x 3 x 13 mm)



ZGZB2

Nut System for Gibson guitars, blank, with integrated zero fret
45.4 x 11.1 x 12mm



ZGZB4

Nut System for Martin guitars, blank with integrated zero fret,
48 x 11.1 x 11.9mm



ZGZB6

Nut System, for Taylor guitars, blank with integrated zero fret,
47.3x11.1x11.9mm



ZGZB11

Nut System for 12-string, blank with integrated zero fret
50.7 x 11.1 x 11.9mm

**ZGZB12F**

Nut System for Fender guitars,
blank with integrated zero fret,
42,9 x 4,2 x 5,1mm

**ZGZB13**

Nut System, for acoustic guitars,
blank with integrated zero fret,
52.5x11.7x11.7mm

**ZGZS1**

Nut System, for Gibson guitars,
slotted, 36mm. Fits various types of
instruments & interchanges easily

**ZGZS1L**

Nut System, for Gibson guitars,
slotted, 36mm, LEFTHAND.
Fits various types of instruments

**ZGZS3**

Nut System, for Martin guitars,
slotted, 34.5mm. Fits various types
of instruments & interchanges easily

**ZGZS5**

Nut System, for Taylor guitars,
slotted, 35.6mm. Fits various types
of instruments & interchanges easily

**ZGZS7F**

Nut System for Fender guitars,
slotted, 34.8mm. Fits various types
of instruments & interchanges easily

**ZGZS7FL**

Nut System for Fender guitars,
slotted, 34.8mm, LEFTHAND. Fits
various types of instruments.

**ZGZS14**

Nut System, for acoustic guitars,
slotted, 37.5mm, with integrated
zero fret.

**ZGZS15**

Nut System, for acoustic guitars,
slotted, 38.5mm, with integrated
zero fret.

**ZGZB9**

Nut System, for banjo/mandolin,
blank with integrated zero fret,
38x11.9x5.9mm

**ZGZS10**

Nut System for mandolin, **slotted**,
24.5mm, with integrated zero fret.

**ZGZS16**

Nut System for mandolin, **slotted**,
flat, 24.5mm, with integrated zero
fret.



Shims



SC-20232201
Tremolo nut shims (LockMeister, Schaller), stainless steel, 5pcs.. 0,1mm.

Locking nuts



SC-20040102
Locking Nut 6 right, nickel. With mounting screws from top & underneath + nut caps. R3: **SC-20040103**
Left: **SC-20040112**
R3 Left: **SC-20040113**

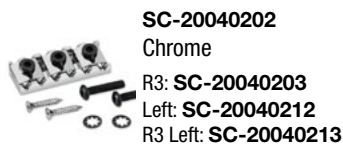

SC-20040202
Chrome
R3: **SC-20040203**
Left: **SC-20040212**
R3 Left: **SC-20040213**



SC-20040502
Gold
R3: **SC-20040503**
Left: **SC-20040512**
R3 Left: **SC-20040513**



SC-20040302
Satin Chrome
R3: **SC-20040303**
Left: **SC-20040312**
R3 Left: **SC-20040313**



SC-20040602
Ruthenium
R3: **SC-20040603**
Left: **SC-20040612**
R3 Left: **SC-20040613**



SC-20040402
Black Chrome
R3: **SC-20040403**
Left: **SC-20040412**
R3 Left: **SC-20040413**



SC-20500102
Locking Nut 7-Strings, nickel. With mounting screws from top & underneath and nut caps.



SC-20500202
Chrome

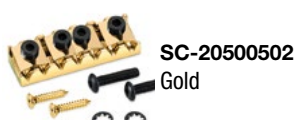

SC-20500502
Gold



SC-20500302
Satin Chrome



SC-20500602
Ruthenium



SC-20500402
Black Chrome



FRETWIRE

ACCU-FRET® FRETWIRE

ACCU-FRET® FRETWIRE

Accu-fret® fretwire is manufactured from a nickel/silver alloy, sometimes called German silver. The percentage indicated on the chart refers to nickel content, most commonly 18%. "Hard" and "Soft" refer to how malleable the fretwire is: hard fretwire is more difficult to shape and is better suited to large radius or flat, classical fretboard; soft fretwire is easier to shape and is more suited to small radius fretboards. Dunlop Accu-fret fretwire is also available in brass and 18% nickel content in soft condition, and 12% nickel content in both hard and soft conditions, offering a tremendous array of fretwire for luthiers worldwide.

ACCU-FRET POUNDS

Fretwire is available coiled, in lengths, or by pound weight. (2 lbs. minimum)

ACCU-FRET 2 LB. BOX

Contains 2 lbs. of coiled fretwire in a pre-packed box. Please indicate the Fret No. when ordering.

(FRET NO.) C2 ACCU-FRET 2 LB. BOX

ACCU-FRET TUBES

For the repairman or facility preferring to work with lengths rather than precut material we offer 20 two foot (.609 meter) lengths, straightened.

6T2/(FRET NO.) ACCU-FRET® TUBE
PACKAGED IN A CARDBOARD STORAGE TUBE

ACCU-FRET SETS

Contains 24 straightened and precut to 2-5/8" (66.67mm) frets. Easy to bend for curved fingerboards.

6S/(FRET NO.) ACCU-FRET® SET PACKAGED
IN A RECLOSEABLE CLAMSHELL

STANDARD APPLICATIONS

- 6000 MAX HEIGHT
- 6230 FENDER GUITARS
- 6170 OVERSIZED FRET SLOTS
- 6130 GIBSON GUITARS ("JUMBO" WIRE)
- 6290 BANJO
- 6230 MARTIN GUITARS
- 6110 BASS
- 6000 MAXIMUM MASS
- 6100 MAXIMUM MASS
- 6110 MAXIMUM MASS

NO.	MATERIAL		A		B		C		D		E							
			-	+	-	+	-	+	-	+	-	+						
LARGE OR JUMBO	6000	18% N/S HARD	MM	0.200	3.250	0.200	0.150	2.990	0.050	0.100	0.910	0.050	0.050	0.530	0.050	0.075	1.470	0.07
		IN.	0.008	0.128	0.008	0.006	0.118	0.002	0.004	0.036	0.002	0.002	0.021	0.002	0.003	0.058	0.00	
	6100	18% N/S HARD	MM	0.200	3.180	0.100	0.150	2.790	0.050	0.100	0.810	0.050	0.050	0.530	0.050	0.075	1.400	0.07
		IN.	0.008	0.125	0.004	0.006	0.110	0.002	0.004	0.032	0.002	0.002	0.021	0.002	0.003	0.055	0.00	
	6105	18% N/S HARD	MM	0.200	2.990	0.200	0.150	2.290	0.050	0.100	0.790	0.050	0.050	0.530	0.050	0.075	1.400	0.07
		IN.	0.008	0.118	0.008	0.006	0.090	0.002	0.004	0.031	0.002	0.002	0.021	0.002	0.003	0.055	0.00	
	6110	18% N/S HARD	MM	0.200	2.640	0.100	0.150	2.920	0.050	0.100	0.910	0.050	0.050	0.510	0.050	0.075	1.270	0.07
		IN.	0.008	0.104	0.004	0.006	0.115	0.002	0.004	0.036	0.002	0.002	0.020	0.002	0.003	0.050	0.00	
	6120	18% N/S HARD	MM	0.150	3.000	0.150	0.050	2.900	0.050	0.050	0.950	0.030	0.050	0.600	0.050	0.030	1.300	0.03
		IN.	0.006	0.118	0.006	0.002	0.114	0.002	0.002	0.037	0.001	0.002	0.024	0.002	0.001	0.051	0.00	
	6130	18% N/S HARD	MM	0.203	2.794	0.203	0.051	2.692	0.051	0.076	0.914	0.076	0.051	0.508	0.051	0.051	0.914	0.05
		IN.	0.008	0.110	0.008	0.002	0.106	0.002	0.003	0.036	0.003	0.002	0.020	0.002	0.002	0.036	0.00	
6140	18% N/S HARD	MM	0.150	2.800	0.150	0.050	2.700	0.050	0.050	0.950	0.050	0.030	0.600	0.030	0.050	1.000	0.05	
	IN.	0.006	0.110	0.006	0.002	0.106	0.002	0.002	0.037	0.002	0.001	0.024	0.001	0.002	0.039	0.00		
6150	18% N/S HARD	MM	0.020	2.743	0.100	0.150	2.591	0.050	0.100	0.787	0.050	0.050	0.510	0.050	0.075	1.067	0.07	
	IN.	0.001	0.108	0.004	0.006	0.102	0.002	0.004	0.031	0.002	0.002	0.020	0.002	0.003	0.042	0.00		
6155	18% N/S SOFT	MM	0.203	2.870	0.203	0.051	2.616	0.051	0.076	0.787	0.076	0.051	0.533	0.051	0.051	1.168	0.05	
	IN.	0.008	0.113	0.008	0.002	0.103	0.002	0.003	0.031	0.003	0.002	0.021	0.002	0.002	0.046	0.00		
6170	12% N/S HARD	MM	0.250	3.280	0.250	0.020	2.500	0.100	0.250	1.220	0.260	0.030	0.600	0.020	0.050	1.100	0.05	
	IN.	0.010	0.129	0.010	0.001	0.098	0.004	0.010	0.048	0.010	0.001	0.024	0.001	0.002	0.043	0.00		
MEDIUM OR REGULAR	6180	BRASS	MM	0.250	2.570	0.250	0.240	2.720	0.100	0.250	0.890	0.250	0.030	0.500	0.180	0.050	1.100	0.05
		IN.	0.010	0.101	0.010	0.009	0.107	0.004	0.010	0.035	0.010	0.001	0.020	0.007	0.002	0.043	0.00	
	6190	18% N/S HARD	MM	0.210	2.390	0.200	0.050	2.130	0.050	0.080	0.740	0.070	0.050	0.510	0.050	0.050	0.990	0.05
		IN.	0.008	0.094	0.008	0.002	0.084	0.002	0.003	0.029	0.003	0.002	0.020	0.002	0.002	0.039	0.00	
	6200	12% N/S HARD	MM	0.260	2.540	0.280	0.020	2.000	0.100	0.250	1.140	0.260	0.030	0.600	0.020	0.100	1.100	0.05
		IN.	0.010	0.100	0.011	0.001	0.079	0.004	0.010	0.045	0.010	0.001	0.024	0.001	0.004	0.043	0.00	
	6210	12% N/S SOFT	MM	0.250	2.540	0.250	0.050	2.000	0.150	0.270	0.860	0.250	0.040	0.500	0.040	0.050	1.100	0.05
		IN.	0.010	0.100	0.010	0.002	0.079	0.006	0.011	0.034	0.010	0.002	0.020	0.002	0.002	0.043	0.00	
	6220	12% N/S HARD	MM	0.250	2.400	0.250	0.020	2.000	0.080	0.250	0.960	0.250	0.040	0.500	0.040	0.050	1.100	0.05
		IN.	0.010	0.094	0.010	0.001	0.079	0.003	0.010	0.038	0.010	0.002	0.020	0.002	0.002	0.043	0.00	
	6230	18% N/S HARD	MM	0.260	2.480	0.240	0.010	1.990	0.100	0.100	0.900	0.100	0.060	0.520	0.020	0.050	1.080	0.07
		IN.	0.010	0.098	0.009	0.000	0.078	0.004	0.004	0.035	0.004	0.002	0.020	0.001	0.002	0.043	0.00	
6240	18% N/S HARD	MM	0.203	2.388	0.203	0.051	2.032	0.051	0.076	0.787	0.076	0.051	0.483	0.051	0.051	0.940	0.05	
	IN.	0.008	0.094	0.008	0.002	0.080	0.002	0.003	0.031	0.003	0.002	0.019	0.002	0.002	0.037	0.00		
6250	18% N/S HARD	MM	0.203	2.413	0.203	0.051	1.905	0.051	0.076	0.914	0.076	0.051	0.508	0.051	0.051	0.762	0.05	
	IN.	0.008	0.095	0.008	0.002	0.075	0.002	0.003	0.036	0.003	0.002	0.020	0.002	0.002	0.030	0.00		
6260	18% N/S HARD	MM	0.150	2.800	0.150	0.100	2.000	0.100	0.050	0.950	0.050	0.050	0.600	0.050	0.030	1.000	0.03	
	IN.	0.006	0.110	0.006	0.004	0.079	0.004	0.002	0.037	0.002	0.002	0.024	0.002	0.001	0.039	0.00		
6265	18% N/S SOFT	MM	0.150	2.800	0.150	0.100	2.000	0.100	0.050	0.950	0.050	0.050	0.600	0.050	0.030	1.000	0.03	
	IN.	0.006	0.110	0.006	0.004	0.079	0.004	0.002	0.037	0.002	0.002	0.024	0.002	0.001	0.039	0.00		
6270	18% N/S HARD	MM	0.203	2.540	0.203	0.051	1.905	0.051	0.076	0.914	0.076	0.051	0.508	0.051	0.051	0.762	0.05	
	IN.	0.008	0.100	0.008	0.002	0.075	0.002	0.003	0.036	0.003	0.002	0.020	0.002	0.002	0.030	0.00		
6290	18% N/S HARD	MM	0.203	2.337	0.203	0.051	1.981	0.051	0.076	0.787	0.076	0.051	0.508	0.051	0.051	1.016	0.05	
	IN.	0.008	0.092	0.008	0.002	0.078	0.002	0.003	0.031	0.003	0.002	0.020	0.002	0.002	0.040	0.00		
SMALL	6300	12% N/S HARD	MM	0.250	1.940	0.250	0.020	1.600	0.120	0.250	0.960	0.250	0.030	0.600	0.020	0.140	0.640	0.05
		IN.	0.010	0.076	0.010	0.001	0.063	0.005	0.010	0.038	0.010	0.001	0.024	0.001	0.006	0.025	0.00	
	6310	18% N/S HARD	MM	0.203	2.311	0.203	0.051	1.346	0.051	0.076	0.940	0.076	0.051	0.559	0.051	0.051	0.787	0.05
		IN.	0.008	0.091	0.008	0.002	0.053	0.002	0.003	0.037	0.003	0.002	0.022	0.002	0.002	0.031	0.00	
	6320	18% N/S HARD	MM	0.203	2.159	0.203	0.051	1.194	0.051	0.076	0.711	0.076	0.051	0.533	0.051	0.051	0.737	0.05
		IN.	0.008	0.085	0.008	0.002	0.047	0.002	0.003	0.028	0.003	0.002	0.021	0.002	0.002	0.029	0.00	
6330	18% N/S HARD	MM	0.203	2.388	0.203	0.051	1.092	0.051	0.076	0.787	0.076	0.051	0.508	0.051	0.051	0.787	0.05	
	IN.	0.008	0.094	0.008	0.002	0.043	0.002	0.003	0.031	0.003	0.002	0.020	0.002	0.002	0.031	0.00		

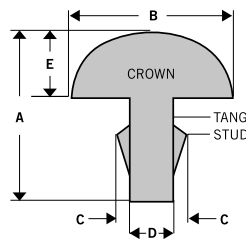



6180

Accu-Fret Fretwire, Medium or Regular, Brass, piece of 60cm

See page 151 for other models



6S-6210

Accu-Frets Fretwire Medium / Regular (Bag of 24 pieces)

More products on our website www.wharry.ch



6150C2

Fretwire Bulk, 1 Coil of 2 LB

More products on our website www.wharry.ch



099-1998-000

GUITAR & BASS PARTS, Fret Wire, Standard Guitar (24)



WS010

Fret Wire, short, pack of 25 pcs, 7cm «Jumbo» 2.7x1mm



WS011

Fret Wire, short, pack of 25 pcs, 7cm 2.2x1mm



WS012

Fret Wire, short, pack of 25 pcs, 7cm «Slim J.» 2.3x1.3mm



WS014

Fret Wire, short, pack of 25 pcs, 7cm «Extra» 2.8x1.3mm



WS214

Fret Wire, long, piece of 24cm, pre-bowed, «Extra» 2.8x1.3mm



WS211

Fret Wire, short 2.2x1mm



WS212

Fret Wire, short «Slim J.» 2.3x1.3mm

PICKGUARDS & PLATES





For Strat

099-1358-000

8-Hole '50s Vintage-Style Strat S/S/S 3-Ply Pickguard, black. Fits 1950s-style American Vintage, Hot Rod, Road Worn, Classic Player & Classic series Strat. with 3 single-coil pickups.



099-2017-000

8-Hole '50s Vintage-Style Strat S/S/S 1-Ply Pickguard, white. Fits 1950s-style American Vintage, Hot Rod, Road Worn, Classic Player with 3 single-coil pickups.



099-2143-000

8-Hole '50s Vintage-Style Strat S/S/S 1-Ply Pickguard, gold. Fits 1950s-style American Vintage, Hot Rod, Road Worn, Classic Player with 3 single-coil pickups.



099-1349-000

8-Hole '50s Vintage-Style Strat S/S/S 4-Ply Pickguard, tortoise. Fits 1950s-style American Vintage, Hot Rod, Road Worn, Classic Player with 3 single-coil pickups.



099-1345-000

11-Hole '60s Vintage-Style Strat S/S/S 3-Ply Pickguard, black. Fits several 1960s-style American Vintage, Hot Rod, Road Worn & Classic Player Strat models w/ 3 single-coil pickups.



099-2018-000

11-Hole '60s Vintage-Style Strat S/S/S 3-Ply Pickguard, white. Fits several 1960s-style American Vintage, Hot Rod, Road Worn & Classic Player Strat models w/ 3 single-coil pickups.



099-1343-000

11-Hole '60s Vintage-Style Strat S/S/S 1-Ply Pickguard, mint green. Fits several 1960s-style American Vintage, Hot Rod, Road Worn & Classic Player Strat w/ 3 single-coil pickups.



099-1344-000

11-Hole '60s Vintage-Style Strat S/S/S 4-Ply Pickguard, tortoise shell. Fits several 1960s-style American Vintage, Hot Rod, Road Worn & Classic Player Strat w/ 3 single-coil pickups.



099-4245-049

Pure Vintage '56-'59 Strat 1-Ply Pickguard, Eggshell. Fits most vintage and modern Stratocaster® guitars with S/S/S configuration



099-1359-000

11-Hole Modern-Style Strat S/S/S 3-Ply Pickguard, black. For a variety of modern Stratocaster models with three single-coil pickups.



099-1360-000

11-Hole Modern-Style Strat S/S/S 3-Ply Pickguard, white. For a variety of modern Stratocaster models with three single-coil pickups.



099-2144-000

11-Hole Modern-Style Strat S/S/S 3-Ply Pickguard, mint green. For a variety of modern Stratocaster models with three single-coil pickups.



099-2142-000

11-Hole Modern-Style Strat S/S/S 4-Ply Pickguard, tortoise shell. For a variety of modern Stratocaster models with three single-coil pickups.



099-2140-000

11-Hole Modern-Style Strat S/S/S 4-Ply Pickguard, White Moto. For a variety of modern Stratocaster models with three single-coil pickups.



099-2140-001

11-Hole Modern-Style Strat S/S/S 4-Ply Pickguard, Aged White Moto. For a variety of modern Stratocaster models with three single-coil pickups.



099-2141-000

11-Hole Modern-Style Strat S/S/S 4-Ply Pickguard, black Moto. For a variety of modern Stratocaster models with three single-coil pickups.



099-2139-000
11-Hole Modern Anodized Aluminium 1-Ply Pickguard for Strat S/S/S, gold. For a variety of modern Fender & Squier Strat models with three single-coil pickups.



099-1360-100
11-Hole Modern-Style Plated Brass Strat S/S/S 1-Ply Pickguard, chrome. For a variety of modern Strat models with three single-coil pickups.



005-6199-000
11-Hole Modern-Style Strat S/S/S (Left Hand) 3-Ply Pickguard, parchment. For a variety of left-handed Strat. with 3 single-coil pickups.



099-2146-000
11-Hole Modern-Style H/S/S Ultra Series Strat 4-Ply Pickguard, black shell. For a variety of HSS Stratocaster models from 1986-present.



005-5267-000
11-Hole Strat H/S/S 3-Ply Pickguard (3-Screw Humbucking Pickup Mount), black. Fits most HSS Stratocaster models.



099-1337-000
11-Hole Modern-Style Strat H/S/S 4-Ply Pickguard, tortoise shell. For a variety of HSS Stratocaster models (1986-present)



099-1338-000
11-Hole Modern-Style Strat H/S/S 4-Ply Pickguard, aged white moto. For a variety of HSS Stratocaster models (1986-present)



099-2019-000
Pure Vintage Five-Hole Mount Telecaster 1-Ply Pickguard, black. For most vintage and modern Telecaster guitars

For Tele



005-8678-002
12-Hole '69 Tele® Thinline 4-Ply Pickguard, white pearl. For Mexico-made '69 Telecaster Thinline model



005-4571-002
11-Hole '72 Tele® Thinline 4-Ply Pickguard, white pearl. For Mexico-made '72' Thinline Telecaster guitars

LAST ONES

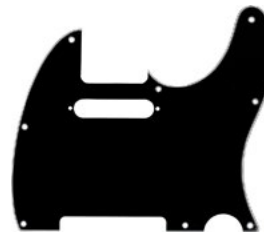

099-1356-000
8-Hole Mount Multi-Ply Tele® 3-Ply Pickguard, black. For a variety of modern Telecaster models.



099-1355-000
8-Hole Mount Multi-Ply Tele® 3-Ply Pickguard, white. For a variety of modern Telecaster models.

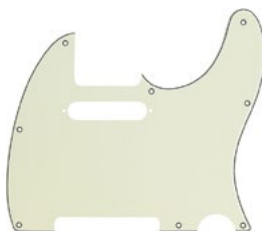

099-2154-000
8-Hole Mount Multi-Ply Tele® 3-Ply Pickguard, mint green. For a variety of modern Telecaster models.



099-2152-000
8-Hole Mount Multi-Ply Tele® 4-Ply Pickguard, tortoise shell. For a variety of modern Telecaster models.

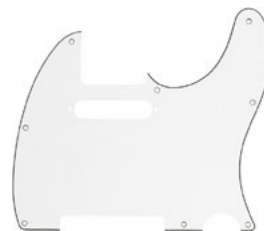

099-1375-000
8-Hole Mount Multi-Ply Tele® 3-Ply Pickguard, parchment. For a variety of modern Telecaster models.



099-2150-000
8-Hole Mount Tele® 4-Ply Pickguard, white moto. For a variety of modern Telecaster models.



099-2174-000
8-Hole Mount Tele® 4-Ply Pickguard, Aged White Pearl. For a variety of modern Telecaster models.



099-1355-100
8-Hole Mount Plated Tele® 1-Ply Pickguard, chrome. For a variety of modern Telecaster models.



009-4062-049
5-Hole Mount Vinyl Tele® 1-Ply Pickguard, eggshell. Fits most vintage and modern Telecaster guitars



005-4523-049
16-Hole Mount '72 Tele® Custom HH 3-Ply Pickguard, black. Fit '72 Tele® Custom (Mexico) manufactured from 1999-Present.



005-8678-002
11-Hole Mount '69 Tele® Thinline 4-Ply Pickguard, white pearl. For Mexico-made '69 Telecaster Thinline model



005-4571-002
11-Hole Mount '72 Tele® Thinline 4-Ply Pickguard, white pearl. For Mexico-made '72 Telecaster Thinline model



099-2022-000
11-Hole Vintage Mount Jazz Bass® (with Truss Rod Notch) 4-Ply Pickguard, Tortoise Shell. Fits American Vintage '62 Jazz Bass models (does not fit five-string models)

For Jazz Bass



099-1351-000
10-Hole Contemporary Jazz Bass® 3-Ply Pickguard, black. For a variety of 4-string Jazz Bass models



099-2170-000
10-Hole Contemporary Jazz Bass® 4-Ply Pickguard, white pearl. For a variety of 4-string Jazz Bass models



099-2157-000
10-Hole Contemporary Jazz Bass® (with Truss Rod Notch) 4-Ply Pickguard, tortoise shell. For a variety of 4-string Jazz Bass models



006-3313-000
10-Hole Contemporary Jazz Bass® 3-Ply Pickguard, black. For 5-string American, American Standard, Standard & Deluxe Jazz Bass.



005-3308-049
10-Hole Am./Mex. Std Jazz Bass® 4-Ply Pickguard, tortoise shell, V String Models. For a variety of American & Mexican 5-string Jazz Bass models



005-5252-049
10-Hole Pure Vintage '70s Jazz Bass® 3-Ply Pickguard, black. Fits most vintage and modern Jazz Bass guitars; will not fit five-string or American Deluxe models



For Precision Bass

099-2020-000
10-Hole '50s Vintage-Style Precision Bass® Pickguard, gold anodized. For American Vintage '57 Precision Bass models.



099-2021-000
13-Hole '60s Vintage-Style Precision Bass® 4-Ply Pickguard, tortoise shell. For American, American Standard, American Vintage, Standard and Deluxe series Precision Bass models.

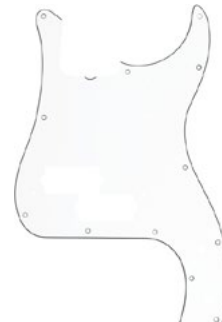

099-1361-000
13-Hole '60s Vintage-Style Precision Bass® 3-Ply Pickguard, white. For American, American Standard, American Vintage, Standard and Deluxe series Precision Bass models.



099-1352-000

13-Hole Multi-Ply Modern-Style Precision Bass® 3-Ply Pickguard, Truss rod notch, black. Fits American, Standard, Vintage & Deluxe series (does not fit 5-string Precision)



099-1376-000

13-Hole Multi-Ply Modern-Style Precision Bass® 3-Ply Pickguard, Truss rod notch, parchment. Fits American, Standard, Vintage & Deluxe series (does not fit 5-string Precision)



005-8261-000

13-Hole Modern-Style Standard Precision Bass® 3-Ply, W/B/W. Fits American, American Standard, Vintage, Standard & Deluxe series Precision Bass (does not fit 5-string).



For Jaguar

009-4464-049

Pure Vintage '65 Jaguar® 3-Ply Pickguard, Brown Shell. Fits most vintage and modern Jaguar® guitars



For Jazzmaster Bass

099-1354-000

American Vintage Jazzmaster® 4-Ply Pickguard, Tortoise Shell. For American Vintage Jazzmaster models (1999-present)



Backplates

099-1320-000

Stratocaster® Vintage-Style Tremolo Backplate, 1-ply, white. Vintage-style single-ply Stratocaster tremolo backplate with 6 string holes.

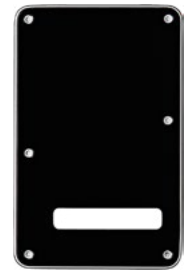

099-1322-000

Stratocaster® Modern-Style Tremolo Backplate, 3-ply, black. Modern single-ply Strat. tremolo backplate with single large string slot.



099-1321-000

Stratocaster® Modern-Style Tremolo Backplate, 3-ply, white. Modern single-ply Strat. tremolo backplate with single large string slot.



099-1323-000

Stratocaster® Modern-Style Tremolo Backplate, 4-ply, white moto. Modern single-ply Stratocaster tremolo backplate with single large string slot.



006-3266-000

Stratocaster® Modern-Style Tremolo Backplate, 1-ply, black. Modern single-ply Strat. tremolo backplate with single large string slot.



005-5274-049

Stratocaster® Vintage-Style Tremolo Backplate, 1-ply, black.

Neckplates



099-1445-100

4-Bolt American Guitar Neck Plate with «Fender Corona» Stamp. For most Fender guitars using 4-screw neck mounting with Micro-Tilt adjst.



099-7216-000

Road Worn® Guitar Neck Plate (No Logo), chrome, w/Hardware. Crafted to give your Strat® the aged look and feel of a well-loved original.



099-1447-100

4-Bolt Vintage-Style Neck Plate (No Logo), chrome. For US + Mex.-Fender guitars & basses, 4-screw neck mount., no Micro-Tilt (1952-present)



099-1447-200

4-Bolt Vintage-Style Neck Plate (No Logo), gold. For US + Mex.-Fender guitars & basses, 4-screw neck mount., no Micro-Tilt (1952-present)



099-1448-100
4-Bolt '70s Vintage-Style F Logo Neck Plate, chrome. For most Fender guitars and basses with four-screw neck mounting and no Micro-Tilt adjustment



005-9209-049
4-Bolt American Deluxe Guitar Neck Plate, Chrome. For American Deluxe guitars (2004-present). Rounded for contoured-heel design. Micro-Tilt adjustment hole



005-4525-049
3-Hole 70's «F» Vintage Style Neck Plate, chrome. For Am. Vintage & Classic series 70s guitar (1995-present, fits most 70s-era Fender with 3-screw neck mounting & Micro-Tilt)



099-1446-100
4-Bolt American Series Bass Neck Plate. For most Fender basses using four-screw neck mounting without Micro-Tilt adjustment

Control Plates



099-2058-000
Telecaster® Control Plates, chrome. 2-hole control plate of the shape used for nearly every Tele from 1952-present. Mounting screws included.



099-2058-200
Telecaster® Control Plates, gold. 2-hole control plate of the shape used for nearly every Tele from 1952-present. Mounting screws included.



099-2055-000
American Vintage '62 Jazz Bass Control Plate (3-Hole), chrome. 3-hole control plate for American Vintage '62 Jazz Bass with stacked pots. Mounting hardware included.



099-2057-100
Jazz Bass Control Plates (4-Hole), chrome. 4-hole control plate fits most US- & Mexico-made Jazz Bass® models from 1964-present. Mounting screws included.



003-5332-000
'51 Precision Bass® Control Plate, chrome. Use on Japanese-made '51 P-Bass reissue models from 1994-2010. Mounting screws not include.



PG01B
Pickguard for Strat, SSS, matt black, 1-layer. For 3 single coil pickups, 3 pots, F-style switch.



PG01W
Pickguard for Strat, SSS, white, 1-layer. For 3 single coil pickups, 3 pots, F-style switch.



PG03B
Pickguard for Strat, SSS, black, 3-layer. For 3 single coil pickups, 3 pots, F-style switch.



PG03W
Pickguard for Strat, SSS, white, 3-layer. For 3 single coil pickups, 3 pots, F-style switch.



PG03A
Pickguard for Strat, SSS, aged white, 3-layer. For 3 single coil pickups, 3 pots, F-style switch.



PG03K
Pickguard for Strat, SSS, vintage mint, 3-layer. For 3 single coil pickups, 3 pots, F-style switch.



PG03L
Pickguard for Strat, SSS, leopard, 3-layer. For 3 single coil pickups, 3 pots, F-style switch.



PG04T

Pickguard for Strat, SSS, tortoise, 4-layer. For 3 single coil pickups, 3 pots, F-style switch.



PG04P

Pickguard for Strat, SSS, pearl, 4-layer. For 3 single coil pickups, 3 pots, F-style switch.



PGSAA

Pickguard for Strat, SSS, Heavy Alu. For 3 single coil pickups, 3 pots, F-style switch.



PGSKR

Pickguard for Strat, SSS, Croco black. For 3 single coil pickups, 3 pots, F-style switch.



PG0LB

Pickguard for Strat LEFT, SSS, matt black, 1-layer. For 3 single coil pickups, 3 pots, F-style switch.



PG0LK

Pickguard for Strat LEFT, SSS, vintage mint, 1-layer. For 3 single coil pickups, 3 pots, F-style switch.



PG23K

Pickguard for Strat, SSS, vintage mint. For 3 single coil pickups, F-style switch - no pots!



PG05B

Pickguard for Strat, HSH, black, 3-layer. For 2 humbuckers, 1 single coil pickup, 3 pots, F-style switch.



PG05W

Pickguard for Strat, HSH, white, 3-layer. For 2 humbuckers, 1 single coil pickup, 3 pots, F-style switch.



PG05K

Pickguard for Strat, HSH, vintage mint, 3-layer. For 2 humbuckers, 1 single coil pickup, 3 pots, F-style switch.



PG13B

Pickguard for Strat, HSS, black, 3-layer. For 1 humbucker, 2 single coil pickups, 3 pots, F-style switch.



PG13W

Pickguard for Strat, HSS, white, 3-layer. For 1 humbucker, 2 single coil pickups, 3 pots, F-style switch.



PG13K

Pickguard for Strat, HSS, vintage mint, 3-layer. For 1 humbucker, 2 single coil pickups, 3 pots, F-style switch.



PG14P

Pickguard for Strat, HSS, vintage pearlloid, 3-layer. For 1 humbucker, 2 single coil pickups, 3 pots, F-style switch.



PG11B

Pickguard for Strat, "blanco", black, 1-layer. No pickup routing, no pots.



PG11K

Pickguard for Strat, "blanco", vintage mint, 3-layer. No pickup routing, no pots.



For
Tele

PGT1B
5-hole pickguard for Tele, matt black, 1-layer.



PGT1W
5-hole pickguard for Tele, white, 1-layer.



PGT3B
8-hole pickguard for Tele, black, 3-layer.



PGT3W
8-hole pickguard for Tele, white, 3-layer.



PGT3A
8-hole pickguard for Tele, aged-white, 3-layer.



PGT3K
8-hole pickguard for Tele, vintage mint, 3-layer.



PGT4T
8-hole pickguard for Tele, tortoise, 4-layer.



PGT4P
8-hole pickguard for Tele, pearl, 4-layer.



PGTBA
Bakelit Pickguard for Tele, black, 1-layer. We got it! Look and feel just like in the old days, in Leo's radio shop. 5 holes, 2mm thick.



XTH3B
Pickguard for Tele, 1 Humbucker, black, 3-layer



XTH3P
Pickguard for Tele, 1 Humbucker, pearl, 3-layer



XTT3T
Pickguard for Tele, "Old Thinline", tortoise, 3-layer



XTT3P
Pickguard for Tele, "Old Thinline", pearl, 3-layer



XTC3P
Pickguard for Tele «Custom», pearl, 3-layer



For Les Paul

PGLPB
Pickguard for Les Paul, incl. bracket, black. For guitars with standard humbuckers.



PGLPK
Pickguard for Les Paul, incl. bracket, cream. For guitars with standard humbuckers.



PGSGB

Pickguard for SG, black, 4-layer.
For SG.



XES4B

Pickguard for ES-Style Archtop Guitars, black, 4-layer. Has a 2nd screw hole for our pickguardholder PH01C/PH01G. Therefore it does not fit on Gibson guitars!



XEX3B

Pickguard for Explorer, black, 3-layer.



XEX3W

Pickguard for Explorer, white, 3-layer.



XFV3B

Pickguard for Flying V, black, 3-layer.



XFV3W

Pickguard for Flying V, white, 3-layer.



XJM3W

Pickguard for Jazzmaster, white, 3-layer.



XJM3P

Pickguard for Jazzmaster, pearl, 3-layer.



XSM3B

Pickguard for SG, black, 3-layer.



XSM3P

Pickguard for SG, pearl, 3-layer.



PG1

Pickguard Western, adhesive, black. One Layer, 0.6mm, self-adhesive.



PG1S

Pickguard Western, adhesive, tortoise. One Layer, 0.6mm, self-adhesive.



PGM3B

Pickguard for Music Man StingRay, 4-string, black, 3-layer.



PGM3P

Pickguard for Music Man StingRay, 4-string, pearl, 3-layer.



PGJ1B

Pickguard for Jazz Bass, matte black, 1-layer.

For
Bass



PGJ3W

Pickguard for Jazz Bass, white, 3-layer.



PGJ3K

Pickguard for Jazz Bass, vintage mint, 3-layer.



PGJ4T

Pickguard for Jazz Bass, tortoise, 4-layer.



PGJ4P

Pickguard for Jazz Bass, pearl, 4-layer.



PGJRT

Pickguard for Jazz Bass, red tortoise, 3-layer.



PGP1B

Pickguard for P-Bass, black, 1-layer.



PGP3B

Pickguard for P-Bass, black, 3-layer.



PGP3W

Pickguard for P-Bass, white, 3-layer.



PGP4T

Pickguard for P-Bass, tortoise, 4-layer.



PGP4P

Pickguard for P-Bass, pearl, 4-layer.



PLT2B

Back Plate for Tremolo Spring Cavity, black, 1-layer.



PLT2W

Back Plate for Tremolo Spring Cavity, off-white, 1-layer.



PLT2V

Back Plate for Tremolo Spring Cavity, vintage mint, 1-layer.

Back-plates



PLT3B

Back Plate for Tremolo Spring Cavity, closed, black, without holes for strings.



PLT4W

Back Plate for Tremolo Spring Cavity, white, 3-layer.



PLT4A

Back Plate for Tremolo Spring Cavity, aged-white, 3-layer.

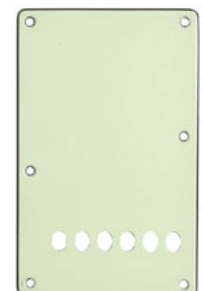

PLT4K

Back Plate for Tremolo Spring Cavity, vintage mint, 3-layer.



PLTRT
Back Plate for Tremolo Spring Cavity, red tortoise.

Control Plates
Tele guitars



CPT1B
Control Plate for Tele, black. Vintage, thickness: 1.6 mm.



CPT1C
Control Plate for Tele, chrome. Vintage, thickness: 1.6 mm.



CPT1G
Control Plate for Tele, gold. Vintage, thickness: 1.6 mm.



CPT2C
Control Plate for Tele, "Space", chrome. The volume pot has a larger distance to the switch. Vintage, thickness: 1.6 mm.



CPT3C
Control Plate for Tele, Toggle Switch, chrome. Pot positions like on the standard version. For G-style toggle switch. Thickness 1.6 mm.



CPT4C
Control Plate for Tele, slanted Switch, chrome. Pot positions like on the «Space» version, with a slanted switch slot. Thickness 1.6 mm.



Control Plates
basses

CPJ1B
Control-Plate for Jazz Bass, black.



Control Plates
basses

CPJ1C
Control-Plate for Jazz Bass, chrome.



CPJ1G
Control-Plate for Jazz Bass, gold.



CPP1C
Control Plate for "old" P-Bass, chrome.



Misc. Plates/
Covers

PGL1B
Les Paul Trussrod Cover, black.



PGL2B
Les Paul Pots Cover, black.



PGL2K
Les Paul Pots Cover, cream.



PGL3B
Les Paul Switch Cover, black.



PGL3K
Les Paul Switch Cover, cream.



PGLPC
Les Paul Pickguard Bracket,
chrome.



PGLPG
Les Paul Pickguard Bracket, gold.



PH01C
Pickguard Bracket, chrome.
Pickguard mounting - for Jazz guitars!



PH01G
Pickguard Bracket, gold. Pickguard
mounting - for Jazz guitars!



PTC3B
Trussrod Cover, 3-hole, black.



NP05B
Neck plate, vintage 4-hole, black.
About 64,5 x 51 x 1,6mm.



NP05C
Neck plate, vintage 4-hole, chrome.
About 64,5 x 51 x 1,6mm.



NP05G
Neck plate, vintage 4-hole, gold.
About 64,5 x 51 x 1,6mm.



NPC1B
Neck plate guard, black, plastic. For
neck plates ca. 64,5 x 51 x 1,6mm.



Control Plate
Tele guitars



GRCPT
Relic Control Plate for Tele, aged
chrome. & afterwards aged at best.
Including a pair of rusty screws.

Neck Plate

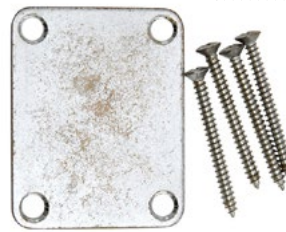

GRNP1
Relic Neck Plate, aged chrome.
Including screws.



HE202
Pickguards «Top Guards», 2 pcs, for
Flamenco guitar, white.



HE203
Pickguards «Top Guards», 2 pcs, for
Flamenco guitar, transparent.



HE232
GUARD PLATES Celluloid Plastic,
1pc, for Acoustic guitar, black.



Neck Plate



KTS05T
Titanium Neck Plate, Titanium.
Neck plate made of «tone-resonant
titanium». KTS imprint.

HARDWARE





Endpins



EP13B

Duesenberg Strap Pin, black. Safest strap attachment - Schaller Security Locks fit. 12mm. Sold in 10.



EP13C

Duesenberg Strap Pin, chrome. Safest strap attachment - Schaller Security Locks fit. 12mm. Sold in 10.



EP13G

Duesenberg Strap Pin, gold. Safest strap attachment - Schaller Security Locks fit. 12mm. Sold in 10.



EPDSB

Duesenberg Drop Stop, black. Two Duesenberg Drop Stop, two compatible strap pins, two wood screws.



EPDSN

Duesenberg Drop Stop, nickel. Two Duesenberg Drop Stop, two compatible strap pins, two wood screws.



EPDSG

Duesenberg Drop Stop, gold. Two Duesenberg Drop Stop, two compatible strap pins, two wood screws.

Misc. Hardware



D-ARM

Armrest, antique. Fits the smaller Duesenberg bodies (52 Senior, 49er, Starplayer Special,...) or other guitars of similar size.



Tools



GTJPT1

Jack and Pot Wrench. Provides 3 thin-wall sockets - 1/2", 7/16", and 12mm - in a compact 4" tool to handle the most common sizes of jacks and pots.



GTTRC2

Truss Rod Driver Cheater, small. Allows quick minor adjustment without removing the neck.



GTTRS1

Truss Rod Driver, big. Allows quick minor adjustment without removing the neck.



GTAW4

Sound Hole Truss Rod Wrench. 4mm, for acoustic guitar.



GTAW5

Sound Hole Truss Rod Wrench. 5mm, for acoustic guitar.



GTSC1

Guitar/Bass String Cutter.



GTMLT1

Guitar/Bass 10-in-1 Multi-Tool. Includes 4 metric + 3 fractional hex keys, Phillips (#1+2) & 2.5mm Slotted screwdrivers, string height ruler.



GTMM2

Mini-Multi Guitar/Bass Multi-Tool. Featuring hex wrenches, screwdrivers, a precision ruler, and other basic tweaks using metric & imperial units.



GTFG1

Casetools, Multi-Tool for Fender Guitars. Includes 1/8" ball-end hex wrench, 1/16" and .05" hex wrenches, and a custom Phillips screwdriver #1 and #2



GTGR1

Guitar Player Tech Kit. Includes Phillips 6-in-1 Screwdrivers, Hex Keys, 15-Blade Thickness Gauge, 6" Stainless Ruler, 150mm Diagonal Cutters, Capo, String Winder.



GTATC1

Acoustic GuitarTech Kit. Includes clever locking bit driver, thickness gauge and capo, screwdriver bits, string winder, String Cutters & telescopic mirror.



GTBAS1

Bass Player Tech Kit. Includes hex wrenches inch&metric, 6-in-1 screwdriver, ruler, capo, thickness Gauge and string cutters.



GTSH1

Stagehand Compact Kit Tools. Includes 19-piece magnetic bit set & holder, inch + metric, screwdrivers, capo and 15-blade thickness gauge, string cutters + a string winder



GTCKIT1

String Change Kit. 1 String Cutter & 1 String Winder.



Strap End Pins



7100

Strap buttons, chrome. 24pcs.



2PSLS031N

Straplok Dual Design Strap Button Set, nickel. Replace standard buttons for a tighter fit or setup an extra instrument for use with the Straplok Retainer System.



2PSLS033BK

Straplok Dual Design Strap Button Set, black. Replace standard buttons for a tighter fit or setup an extra instrument for use with the Straplok Retainer System.



2PSLS034G

Straplok Dual Design Strap Button Set, gold. Replace standard buttons for a tighter fit or setup an extra instrument for use with the Straplok Retainer System.



SLS1031N

Straplock System Dual Design, nickel. 2pcs. Its 360° groove and ball design allows the unit to rotate without catching. Two strap attachments are included for your strap.



SLS1035VN

Straplock System Dual Design, vintage nickel. 2pcs. Its 360° groove & ball design allows the unit to rotate without catching. 2 strap attachments are included for your strap.



SLS1032BR

Straplock System Dual Design, brass. 2pcs. Its 360° groove and ball design allows the unit to rotate without catching. Two strap attachments are included for your strap.



SLS1033BK

Straplock System Dual Design, black oxide. 2pcs. Its 360° groove & ball design allows the unit to rotate without catching. Two strap attachments are included for your strap.



SLS1036BN

Straplock System Dual Design, black chrome. 2pcs. Its 360° groove & ball design allows the unit to rotate without catching. Two strap attachments are included for your strap.



SLS1034G

Straplock System Dual Design, gold. 2pcs. Its 360° groove and ball design allows the unit to rotate without catching. Two strap attachments are included for your strap.



SLS1101N

Original Straplock, nickel. 2pcs. Its 360° groove and ball design allows the unit to rotate without catching.



SLS1102BR

Original Straplock, brass. 2pcs. Its 360° groove and ball design allows the unit to rotate without catching.



SLS1103BK

Original Straplock, black oxide. 2pcs. Its 360° groove and ball design allows the unit to rotate without catching.



SLS1104G

Original Straplock, gold. 2pcs. Its 360° groove and ball design allows the unit to rotate without catching. It holds the strap flat against the guitar.



SLS1401N

Straplok Flush Mount, nickel. 2pcs. Its 360° groove and ball design allows the unit to rotate without catching. Feature an internal mounting for a sleeker profile.



SLS1402BR

Straplok Flush Mount, brass. 2pcs. Its 360° groove and ball design allows the unit to rotate without catching. Feature an internal mounting for a sleeker profile.



SLS1403BK

Straplok Flush Mount, black oxide. 2pcs. Its 360° groove and ball design allows the unit to rotate without catching. Feature an internal mounting for a sleeker profile.



SLS1404G

Straplok Flush Mount, gold. 2pcs. Its 360° groove and ball design allows the unit to rotate without catching. Feature an internal mounting for a sleeker profile.



SLS1501N

Straplok Traditional, nickel. 2pcs. Its 360° groove and ball design allows the unit to rotate without catching. Features an extra wide flange for added security.



SLS1502BR

Straplok Traditional, brass. 2pcs. Its 360° groove and ball design allows the unit to rotate without catching. Features an extra wide flange for added security.



SLS1503BK

Straplok Traditional, black oxide. 2pcs. Its 360° groove and ball design allows the unit to rotate without catching. Features an extra wide flange for added security.



SLS1504G

Straplok Traditional, gold. 2pcs. Its 360° groove and ball design allows the unit to rotate without catching. Features an extra wide flange for added security.



DGT01

System 65 Gig Light. This road-ready flashlight is a gig-saver when you need to set up your amp, arrange your pedalboard, or change your strings on a dark stage..

Tools



DGT02

System 65 Multi-Tool. Features numerous attachments to help you keep your instrument in shape, from adjusting your truss rod to removing your pickguard.



DGT03

System 65 Uni Wrench, stainless steel. Can adjust nearly every nut on your guitar or bass, even the round ones, thanks to the exceptional grip provided by its precision-tooled teeth



DGT04

System 65 Action Gauge. A must for every player's toolkit, provides the precise measurements you need to setup your instr. for greater playability.



DGT05

System 65 Fret Collar. Provides the tools you need for quick and effective fret polishing.



DGT06

System 65 Screwdriver. With 4 bits—2 Phillips-head, 2 flathead—it'll fit practically every screw on your guitar or bass.



DGT07

System 65 String Cutter. Will cut through the thickest bass strings just as smoothly as it'll cut through the thinnest guitar strings.



DGT08

System 65 Compact String Cutter. Will cut through the thickest bass strings just as smoothly as it'll cut through the thinnest guitar strings.



Screws

099-4923-000

Pickguard - Control Plate Mounting Screws, chrome. Set of 24 Phillips head screws (4x1/2") for most Fender instruments.



099-4924-000

Pickguard - Control Plate Mounting Screws, gold. Set of 24 Phillips head screws (4x1/2") for most Fender instruments.



001-8368-049

American Vintage '52 Telecaster® Pickguard-Control Plate Screws, chrome. Set of 12 metal screws. Fits a variety of vintage and contemporary models.



099-4925-000

Pickup + Selector Switch Mounting Screws, chrome. 12x Phillips pan-head 6-32x5/8". For pickup selector-switch mounting on Fender instru.



099-4926-000

Pickup + Selector Switch Mounting Screws, gold. 12x Phillips pan-head 6-32x5/8". For pickup selector-switch mounting on Fender instru.



001-5610-049

Vintage-Style Bass/Tele® Bridge/Strap Button Mounting Screws, nickel. Set of 12 replacement screws. Used on vintage Tele & bass guitars.



001-5578-049

Pickguard-Vintage Bridge Cover Mounting Screws, nickel. Set of 12 replacement screws. Used on modern vintage Fender instruments.



001-6170-049

Vintage-Style Strat® Bridge Mounting Screws, nickel. Set of 12 replacement screws. Used on American Vintage Strat guitars.

**002-1422-049**

Bass/Tele Bridge/Strap Button Mounting Screws, nickel. Set of 12 replacement screws. Used on most American series Tele and bass guitars

**002-8957-049**

Bridge Pivot Screws, chrome. Set of 2 threaded steel screws. For American, Ultra, Standard & some Custom Shop Strat models (1986-present).

**002-8958-049**

Bridge Pivot Screw Inserts, gold. Set of 2, Spline brass design. For American, Ultra, Standard & some Custom Shop Strat models (1986-present).

**099-4928-000**

American Vintage Strat®-Tele® Saddle Height Adjustment Screws, chrome. Set of 12 hex set screws. 4 short (4-40x3/8"), 8 long (4-40x5/16"). For Am. Vintage Strat & Tele.

**099-4927-000**

American Series Bridge Saddle Height Adjustment Screws, black. Set of 12 hex set screws. 4 long (5/16"), 8 short (1/4"). For American & Am. Standard Strat & Tele (1986-2007).

**002-6779-049**

American Series Guitar Bridge Saddle Height Adjustment Screws, black. Complete set of 12 1/4" screws. For American series and Am. Standard guitars (1986-2000).

**001-8027-049**

American Deluxe-Am. Series Tele® Saddle Height Adjustment Screws, black. Set of 12 screws (4-40 x 3/8"). Used on American series & Am. Deluxe Tele (1986-2007).

**004-0800-049**

Standard Series Bass Bridge Saddle Height Adjustment Screws. Set of 12 Allen set screws (6-32x7/16"). For Am. Special & Standard basses.

**001-7031-049**

American Deluxe/Elite Strat®/Tele® Intonation Screws, black. Set of 12 Phillips-head. Used on Am. Series & Deluxe Strat and Tele guitars.

**001-5693-049**

American Vintage Strat® Saddle Intonation Screws, nickel. Set of 12 screws. For American Vintage, Std (2008-Present) & Road Worn Strat.

**099-4948-000**

Neck Mounting Screws, chrome. Set of 4 neck-mounting screws, 8x1-3/4" Phillips head design. For most Fender guitars and basses.

**001-8785-049**

Neck Mounting Screws, gold. Set of 4 neck-mounting screws, 8x1-3/4" Phillips head design. For most Fender guitars and basses.

**099-4922-000**

Knob Set Screws, nickel. Set of 24 nickel set screws 8-32x3/16". For mounting most Tele, P-Bass on solid-shaft pots.

**005-0101-049**

Stacked Control Knob Mounting Screws. Set of 12 (6-32x1/8"). For Am. Deluxe, Deluxe P-Bass, Nashville (2008-Present) & Road Worn Strat.

**001-1357-049**

Pure Vintage Tuning Machine Mounting Screws, nickel. Set of 12 (3x 3/8") Phillips-head. Fits vintage-style & modern guitars + basses.

**002-7035-049**

Pure Vintage Bass Pickup Mounting Screws, nickel. Set of 12 (4x1-1/4") Phillips-head. For vintage & contemporary P- and Jazz Bass models.



001-6295-049
Pure Vintage Jazzmaster®/Tele® Pickup Mounting Screws. Set of 12 (3 x 1") Phillips-head. For vintage & modern Tele/Jazzmaster pickups.



001-6188-049
Pure Vintage Strap Button Mounting Screws. Set of 12 (6 x 1") Phillips-oval-head. Fits most vintage and modern Telecaster & Esquire guitars.



001-8113-049
Battery Cover Mounting Screws. Set of 12 black mounting screws (4x1/2") For most vintage & contemporary Fender instr. with active electronics.



001-8373-049
Pure Vintage Slotted Tele® Neck Pickup Mounting Screws. Set of 12 (3x1") vintage-accurate slotted nickel-plated screws. Fits most vintage and modern Telecaster guitars.



001-8376-049
Pure Vintage Slotted Tele® Bridge Pickup Mounting Screws. Set of 12 (3x1") vintage-accurate slotted nickel-plated screws. Fits most vintage three-saddle Telecaster bridges.



001-8823-049
Pure Vintage Tuning Machine Mounting Screws, gold. Set of 12 (3x 3/8") Phillips-head screws. Fits most vintage-style and modern guitars and basses.



002-1405-049
American Standard/Deluxe Guitar String Tree Mounting Screws, chrome. 12pcs (3x 3/8") Phillips round-head screws. Fits American Standard, Special, Deluxe & Hwy 1.



005-0166-049
Humbucking Pickup Mounting Screws. Set of 12 (3-48x13/16") Phillips round-head screws. For mounting on most Fender instr.



005-0167-049
Humbucking Pickup Mounting Springs. Set of 12 (.175" x 3/4"). For American Deluxe, Sub-Sonic, Highway One, Cyclone, Classic & Deluxe.



String Guides

099-4910-000
Vintage-Style Strat® String Guides, chrome. Set of 2. For American Vintage, Road Worn, Pawn Shop and Classic series Stratocaster models.



001-8803-049
Vintage-Style Strat® String Guides, gold. Set of 2. For American Vintage, Road Worn, Pawn Shop and Classic series Stratocaster models.



099-2083-000
Pure Vintage String Tree Kit, nickel. Used on early '50s and '60s Fender guitars. Fits most vintage and modern Strat® and Tele® guitars.



099-4911-000
American Standard String Guides, chrome. Set of 2. For American, American Standard, American Special and American Deluxe guitar models.



003-9475-049
American Standard String Guides, gold. Set of 2. For American, American Standard, American Special and American Deluxe guitar models.



099-4912-000
Pure Vintage Tele® String Guide, nickel. Minimizes sympathetic overtones from low string tension over the nut. Fits most vintage & modern Tele®.



099-4913-000
Pure Vintage Bass String Guide, nickel. Minimizes sympathetic overtones from low string tension over the nut. Fits most vintage & modern Tele®.



002-7932-049

Bi-Flex™ Truss Rod Cavity Plugs.
Set of 2 walnut dowels. For most American and American Deluxe series guitars.



Strap End Pins

006-3267-049

American Standard Series Strap Buttons. Set of 2 nickel-plated strap buttons. For American & American Standard series (2004-present)



099-4914-000

American Series Locking Strap Buttons, chrome. Set of 2 locking strap buttons. Mounting hardware included. Strap locks not included.



099-4915-000

Pure Vintage Strap Buttons, nickel. Set of 2 vintage-accurate plated-steel strap buttons. Fits most vintage and modern Fender guitars and basses.



001-8916-049

Pure Vintage Strap Buttons, gold. Set of 2 vintage-accurate plated-steel strap buttons. Fits most vintage and modern Fender guitars and basses.



099-4929-000

Strap Button Felt Washers, black. Set of 12 black felt washers used to buffer strap buttons from instrument finishes.



099-4930-000

Strap Button Felt Washers, white. Set of 12 white felt washers used to buffer strap buttons from instrument finishes.



Misc. Hardware

099-4916-000

Pickup Mounting Rubber Tubing. Set of 12 pieces of rubber tubing. For most Fender instruments with pickguard-mount pickups.



099-2036-000

Thumb-Rest for P-Bass® & Jazz Bass. Vintage-style thumb rest. For Precision Bass and Jazz Bass models.



001-7333-049

Pickup Height Foam Strip - Jazz Bass Pickups. Set of 2. 3/8" x 3/8". Used on most P-Bass®, Jazz Bass®, Jazzmaster®, Jaguar® (1989-present).



001-8556-049

Pickup Height Foam Strip. Set of 2. 9/16" x 1/2" neoprene pieces. Used on most P-Bass®, Jazz Bass®, Jazzmaster®, Jaguar® (1989-present).



005-4447-049

American Vintage Bridge Posts - Jaguar®/Jazzmaster® (US). Set of 2. .353" outer diameter. For American Vintage Jaguar & Jazzmaster guitars.

Bridge & End Pins



099-0402-006

Acoustic Bridge Pin Sets, black. Set of 7. Includes extra bridge pin and matching strap end pin. For most Fender acoustic guitars.



099-0402-000

Acoustic Bridge Pin Sets, Ivory. Set of 7. Includes extra bridge pin and matching strap end pin. For most Fender acoustic guitars.



099-0519-000

Custom Shop Tool Kit by GrooveTech. Contains 5-in-1 screwdriver with 4mm hex adapter, mirror, ruler, cutter, capo, feeler gauges, string winder.

Tools



099-0654-020

Guitar & Bass Multi-Tool 14-in-1. Featuring standard and metric sizing, providing maximum functionality for all of your instrument repair and tech work needs.



Screws



SR11B
Self Cutting Pickup Screw, 3x21mm (20 pcs.). For Strat Pickups etc. To fit a Strat or Tele pickup directly to wood.



SR12B
Pickup Screw, 2.5x26mm (20 pcs.). To mount Tele neck pickups or Strat pickups directly in the pickup routing pocket.



SR20B
Screws for Strat Pickups, black (20 pcs.). 19mm, US threads



SR20C
Screws for Strat Pickups, chrome (20 pcs.). 19mm, US threads



SR20G
Screws for Strat Pickups, gold (20 pcs.). 19mm, US threads



SR25B
Screws for Strat Pickups, black (12 pcs.). 17mm, US threads, sunk head!



SR25C
Screws for Strat Pickups, chrome (12 pcs.). 17mm, US threads, sunk head!



SR25G
Screws for Strat Pickups, gold (12 pcs.). 17mm, US threads, sunk head!



SRHZB
Humbucker Height Adjustment Screws, "US", black (20 pcs.). 25mm, US threads.



SRHZC
Humbucker Height Adjustment Screws, "US", chrome (20 pcs.). 25mm, US threads.



SRHZG
Humbucker Height Adjustment Screws, "US", gold (20 pcs.). 25mm, US threads.



SRP9L
Screws for P-90 Soapbar, nickel (20 pcs.). 2.6 x 38.5 mm. Counter-sunk head.



SR1SB
Screws for Bass Pickups, black (20 pcs.). Suitable for P- and J-Bass style pickups as well as P-90 soapbars. 2.5 x 35 mm



SR1SC
Screws for Bass Pickups, chrome (20 pcs.). Suitable for P- and J-Bass style pickups as well as P-90 soapbars. 2.5 x 35 mm



SR1SG
Screws for Bass Pickups, gold (20 pcs.). Suitable for P- and J-Bass style pickups as well as P-90 soapbars. 2.5 x 35 mm



SR00B
Tremolo Bearing Screws for Strat, black (30 pcs.). 3.5 x 30 mm.

**SR00C**

Tremolo Bearing Screws for Strat, nickel (30 pcs.). 3.5 x 30 mm.

**SR00G**

Tremolo Bearing Screws for Strat, gold (30 pcs.). 3.5 x 30 mm.

**SR01B**

Bridge/Endpin Screw, black. (20 pcs.). 3.5 x 32mm.

**SR01C**

Bridge/Endpin Screw, chrome. (20 pcs.). 3.5 x 32mm.

**SR01N**

Bridge/Endpin Screw, nickel. (20 pcs.). 3.5 x 32mm.

**SR01G**

Bridge/Endpin Screw, gold. (20 pcs.). 3.5 x 25mm.

**SR02B**

Neck Attachment Screws, long, black (20 pcs.). 4.2 x 45 mm.

**SR02C**

Neck Attachment Screws, long, chrome (20 pcs.). 4.2 x 45 mm.

**SR02G**

Neck Attachment Screws, long, gold (20 pcs.). 4.2 x 45 mm.

**SR03B**

Neck Attachment Screws, short, black (20 pcs.). 4.2 x 38 mm.

**SR03C**

Neck Attachment Screws, short, chrome (20 pcs.). 4.2 x 38 mm.

**SR04B**

Pickguard screw, F-style, black (50 pcs.). 2.9 x 13 mm.

**SR04C**

Pickguard screw, F-style, chrome (50 pcs.). 2.9 x 13 mm.

**SR04N**

Pickguard screw, F-style, nickel (50 pcs.). 2.9 x 13 mm.

**SR04G**

Pickguard screw, F-style, gold (50 pcs.). 2.9 x 13 mm.

**SR05B**

Humbucker Mounting Screws, short, black (50 pcs.). 2.2 x 9.5 mm.



SR05C
Humbucker Mounting Screws,
short, chrome (50 pcs.).
2.2 x 9.5 mm.



SR05G
Humbucker Mounting Screws,
short, gold (50 pcs.).
2.2 x 9.5 mm.



SR06B
Humbucker Mounting Screws,
long, black (50 pcs.). 2.2 x 16 mm.



SR06C
Humbucker Mounting Screws,
long, chrome (50 pcs.). 2.2 x 16 mm.



SR06G
Humbucker Mounting Screws,
long, gold (sold in 20). 2.2 x 16 mm.



SR07B
Tuner Mounting Screws, black
(50 pcs.). 2.2 x 9.5 mm.



SR07C
Tuner Mounting Screws, chrome
(50 pcs.). 2.2 x 9.5 mm.



SR07G
Tuner Mounting Screws, gold
(50 pcs.). 2.2 x 9.5 mm.



SR09C
Pickguard screw, Vintage G-style,
nickel (20 pcs.). 2.5 x 10 mm.



SR09G
Pickguard screw, Vintage G-style,
gold (20 pcs.). 2.5 x 10 mm.



SR14B
Pickguard Screws, F-Style, long,
black (50 pcs.). 2.9 x 19 mm.



SR14C
Pickguard Screws, F-Style, long,
nickel (50 pcs.). 2.9 x 19 mm.



SR28B
Bridge Mounting Screw, black.
3 x 25 mm.



SR28C
Bridge Mounting Screw, chrome.
3 x 25 mm.



SRD7B
Vintage Tuner Screws, black
(50 pcs.). 2.5 x 10mm. Slightly thicker
than our standard tuner screw SR07,
with a nice classic round head.



SRD7N
Vintage Tuner Screws, nickel
(50 pcs.). 2.5 x 10mm. Slightly thicker
than our standard tuner screw SR07,
with a nice classic round head.

**SRD7G**

Vintage Tuner Screws, gold
(50 pcs.). 2.5 x 10mm. Slightly thicker than our standard tuner screw SR07, with a nice classic round head.

**SRV7C**

Vintage Tuner Screws, nickel
(35 pcs.). 2.5 x 12 mm.

**SR06N**

Allen Screws, stainless steel, M3, 6mm (12 pcs.). For Strat bridge saddles etc...

**SR08B**

Allen Screws, black, M3, 8mm (24 pcs.).

**SR08N**

Allen Screws, stainless steel, M3, 8mm (12 pcs.).

**SR10N**

Allen Screws, stainless steel, M3, 10mm (12 pcs.).

**SR12N**

Allen Screws, stainless steel, M3, 12mm (16 pcs.).

**SR16B**

Threaded Screws for Bridges and Pickups, black (20 pcs.). M3 x 16 mm.

**SR16C**

Threaded Screws for Bridges and Pickups, chrome (20 pcs.). M3 x 16 mm.

**SR16G**

Threaded Screws for Bridges and Pickups, gold (20 pcs.). M3 x 16 mm.

**SR21C**

Allen Screw, US, nickel, 9mm (12 pcs.). US threads.

**SR23C**

Allen Screw, US, nickel, 11mm (8 pcs.). US threads, slotted!

**SR26C**

Intonation Screws for Strat, nickel, 15mm (8 pcs.). US threads.

**SR35N**

Phillips screw, roundhead, nickel, M3 x 35 mm (1 pc.). For some Tele bridges with metric threads.

**SR36C**

Phillips screw for Switches, nickel, M3 x 6 mm (30 pcs.).

**SR40B**

Intonation screw for bass bridge, black, M3 x 40 mm (8 pcs.).

Pickup Kits, Parts,
Wirings



SRUSN
Screw for US-Switch, nickel,
6/32" x 6 mm (US) (8 pcs.).



SRPCN
Pole Screws for Humbuckers &
P-90, nickel, 3 x 18mm (12 pcs.).



SRPCG
Pole Screws for Humbuckers &
P-90, gold, 3 x 18mm (12 pcs.).



SRPPN
Pole Pieces for Humbuckers, nickel,
4.9 x 12.5mm (12 pcs.).



SRPPG
Pole Pieces for Humbuckers, gold,
4.9 x 12.5mm (12 pcs.).



E9063
Vintage Pickup Wire. The same wire
used in the old pickups, 0.063mmØ,
plus the thicker red isolation for
typical low capacity.



E9HB1
Vintage Pickup Cable, 1 meter. Bare,
for '59 Vintage Humbucker.



E9SCB
Cable for Single Coils, black, 1m.
Cloth-coated for singlecoil pickups.



E9SCA
Cable for Single Coils, aged white,
1m. Cloth-coated for singlecoil
pickups.



EL901
Lead Cable for Pickups, shielded,
2-lead, 1m.

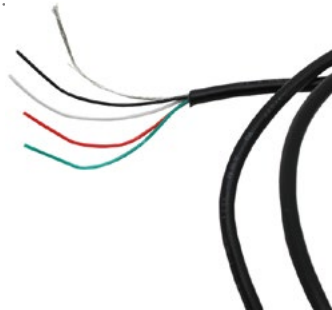

EL905
Lead Cable for Pickups, shielded,
4-lead, 1m.



MX801
Ox Magnet 80x5,3x5(N-S).
For bass pickups.



PHBBB
Humbucker Bobbins, black. Set of
2. 1 for pole screws. 1 for cylindrical
pole pieces, 50mm spacing.



PHBBW
Humbucker Bobbins, white. Set of
2. 1 for pole screws. 1 for cylindrical
pole pieces, 50mm spacing.



PHBBK
Humbucker Bobbins, cream. Set of
2. 1 for pole screws. 1 for cylindrical
pole pieces, 50mm spacing.



PKT1B
Pickup Winding Kit for Tele, Bridge.
Finest components, Alnico magnets,
non-magnetic base plate, all included
except wire.



PKT1N

Pickup Winding Kit for Tele, Neck. Finest components, Alnico magnets, everything included except for the wire.

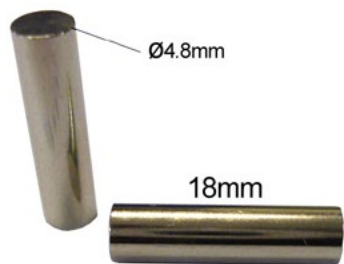

PP185

Pole Piece, 18x4,8mm, nickel plated soft steel. 1 pc. For use with ceramic magnets.



PUK90

Pickup Winding Kit for P-90. Finest components, Alnico 5 magnets, all included except wire.



PUKG1

Pickup Winding Kit for Strat. Finest components, Alnico 5 magnets, all included except wire.



PUKH1

Pickup Winding Kit for Humbucker. 50mm Stringspacing. Finest components, Alnico 5 magnets, all included except wire. 50mm Stringspacing.



PUKB1

Pickup Winding Kit for Jazz Bass, Bridge. Finest components, Alnico 5 magnets, all included except wire.



PUKB2

Pickup Winding Kit for Jazz Bass, Neck. Finest components, Alnico 5 magnets, all included except wire.



PUKB3

Pickup Winding Kit for P-Bass. Finest components, Alnico 5 magnets, all included except wire.

Endpins



EP11A

Strap Pin «Vintage Alu», Aluminum, 12.5mm. Come in 10 pcs.



EP11B

Strap Pin «Standard», black, 14mm. Come in 10 pcs.



EP11C

Strap Pin «Standard», nickel, 14mm. Come in 10 pcs.



EP11G

Strap Pin «Standard», gold, 14mm. Come in 10 pcs.

String Guides/Trees



EP15N

Strap Pin «Plus», nickel, 15mm. Keeps your guitar strap where it belongs. Only in nickel.



NT15B

String Tree Butterfly, black, 1 piece. Downholder for guitar strings.



NT15C

String Tree Butterfly, nickel, 1 piece. Downholder for guitar strings.



NT15G

String Tree Butterfly, gold, 1 piece. Downholder for guitar strings.



NT50B
Roller String Tree, 2 rollers, black,
1 piece.



NT50C
Roller String Tree, 2 rollers, chrome,
1 piece.



NT50G
Roller String Tree, 2 rollers, gold,
1 piece.



NTTVN
Old Style String Trees f. Tele, nickel,
6 pcs.



NT30B
String Trees f. Bass, black, 6 pcs.



NT30C
String Trees f. Bass, nickel, 6 pcs.



NT30G
String Trees f. Bass, gold, 6 pcs.



WS4BU
Trussrod Nut, nickel, US, 8x25mm,
hex 4mm.



WS4FG
Trussrod Nut, nickel, M5, crossed
slot, cylindrical.



WS4FZ
Trussrod Nut, nickel, US, crossed
slot, cylindrical.



WS4GG
Trussrod Nut, G-style, "US" threads.
Suitable nut driver size: 7mm.



WSGM5
Trussrod Nut, M5, hex, 8x8mm.



WSM5X
Trussrod Nut, M5, hex, 10x7mm.



WSTRUSS
2-Way Truss Rod Adjuster, M5. The
brass anchor is fixed to the wood,
so the nut can push or pull the rod,
depending on the direction of rotation.



WS40G
Double Trussrod, 440x6x9mm. A
round and a flat rod, soldered to-
gether at one end, one tightening against
the other. 7mm nut, US threads.
Weight: 164g.



WS41G
Dual-Action Double Trussrod.
440x5x8mm. A round and a flat rod,
soldered together at one end, one
tightened against the other. 4mm hex
nut. Weight: 116g.

Trussrods for Guitars



WS44G

Dual-Action Trussrod, 440x6x9mm. "Right"-threaded at one side and "left"-threaded at the other side, 4mm hex nut. Weight: 132g.



WS46G

Dual-Action Trussrod, allen nut, 460x6x9mm. "Right"-threaded at one side and "left"-threaded at the other side, 4mm hex nut. Weight: 132g.



WS47F

F-style Trussrod, crossed slot nut, 430x5mm. Traditional way. Crossed-slot nut, 76g.

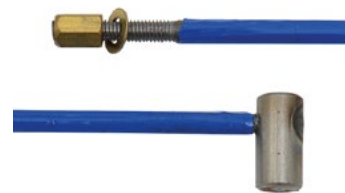

WS47G

G-Style Trussrod, 440x5mm. Cylindrical anchor, 7mm nut, US threads, 74g.



WS48G

Dual-Action Double-Trussrod, 460x6x8.5mm. A round and a flat rod, soldered together at one end, one tightened against the other. 170g.



WS49G

Double Trussrod, 490x10x6mm. A round and a flat rod, soldered together at one end, one tightened against the other. 164g.

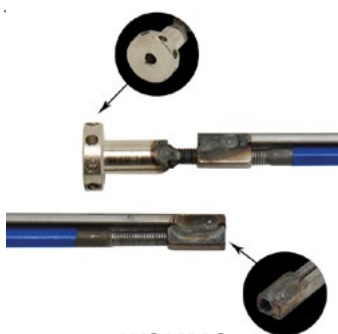

WSMMG

Dual-Action Trussrod, MM-Style, 46.5 x 9 x 6mm. Trussrod for Music Man or similar.



WS40B

Single-Action Double Trussrods, 590x6x9mm. A round and a flat rod, soldered together at one end, one tightening against the other. 218g.

Trussrods for Basses



WS44B

Dual-Action Truss Rod, 590x6x9mm. "Right"-threaded at one side and "left"-threaded at the other side. Weight: 178g.



WS48B

Dual-Action Double-Trussrod, 590x6x8.5mm. A round and a flat rod, soldered together at one end, one tightened against the other. 200g.

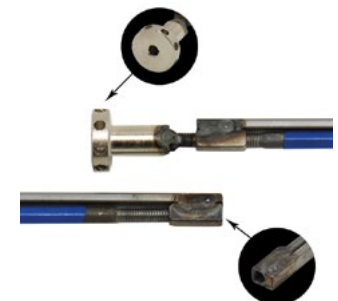

WSMMB

Dual-Action Trussrod, MM-Style, 61.5x9x6mm. Trussrod for Music Man or similar.



Fingerboard Blanks, slotted

FBGBL

Fingerboard with Inlays, Block MOP inlays. Rosewood, 22 fret slots, radiused, 62.9cm.



FBGCR

Fingerboard with Inlays, Crown MOP inlays. Rosewood, 22 fret slots, radiused, 62.9cm.



FBGE1

Fingerboard blank. Ebony, 24 frets. Not rounded from top, Fingerboard blanks for guitar. Planed, no slots, long enough for longscale (64,7cm).



FBGE2

Fingerboard, slotted. Ebony, 24 fret slots. 62.9cm.

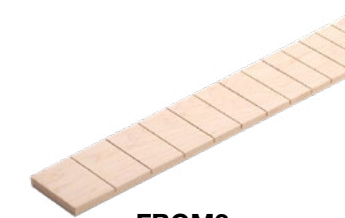

FBGM3

Fingerboard for guitar. Maple. 24 fret slots, 64.7cm scale, planed.



FBGR1

Fingerboard, Guitar, plain.
Rosewood. 24 fret, 64.7cm scale, planed. Not rounded from top, Fingerboard blanks for guitar.



FBGR2

Fingerboard for Guitar. Rosewood. 24 fret slots, 62.9cm scale, planed.



FBGR3

Fingerboard for Guitar. Rosewood. 24 fret slots, 64.7cm scale, planed.



FBB5R

Fingerboard, BASS, 5-string.
Rosewood. No slots, for long scale (86,4cm), 24 frets.

Fretboard Inlays,
Dots



FBB6R

Fingerboard for BASS, slotted, 5-string. Rosewood. 24 fret slots, 86.4cm scale, planed.



FBBR1

Fingerboard, BASS, planed, 5-string. Rosewood. No slots, for long scale (86,4cm), 24 frets.



FBBR2

Fingerboard for BASS, slotted, 4-string. Rosewood. 24 fret slots, 86.4cm scale, planed.



INB10

Block Inlays, Mother-of-Pearl, 10 pcs.



WSBA10

Block Inlays, Acrylic Pearl, 10 pcs. Fingerboard inlay, rectangle shape (e.g. for Les Paul Custom). Plastic.



WSCA9

Crown Inlays, Acrylic Pearl, 9 pcs. Fingerboard inlay, crown shape (e.g. for Les Paul Standard). Plastic.



WS10B

Fingerboard Dots, black, 6mm, 12 pcs.



WS10A

Fingerboard Dots, Abalone, 6mm, 12 pcs.

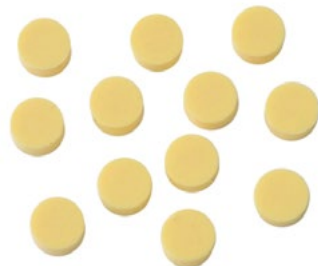

WS10K

Fingerboard Dots, Bonoid «Clay», 6mm, 12 pcs.



WS10H

Fingerboard Dots, Light Cream, 6mm, 12 pcs.



WS10P

Fingerboard Dots, Pearlloid, 6mm, 12 pcs.



WS11B

Side Dots, 2mm, black, 4 pcs. Marker material for the fingerboard's edge, 50 x 2mmØ. Just put in, cut off and sand over.

**WS11W**

Side Dots, 2mm, white, 4 pcs.
Marker material for the fingerboard's edge, 50 x 2mmØ. Just put in, cut off and sand over.

**WS11K**

Side Dots, 2mm, cream, 4 pcs.
Marker material for the fingerboard's edge, 50 x 2mmØ. Just put in, cut off and sand over.

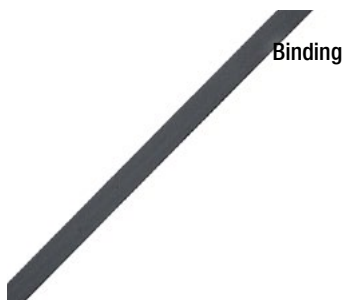

Binding

WS19B

Binding, 1-layer, Black. 1.5 x 7mm.
Length: approx. 1.60m.

**WS20B**

Binding, 1-layer, Black. 1.5 x 6mm.
Length: approx. 1.60m.

**WS20W**

Binding, 1-layer, White. 1.5 x 6mm.
Length: approx. 1.60m.

**WS20K**

Binding, 1-layer, Cream. 1.5 x 6mm.
Length: approx. 1.60m.

**WS20P**

Binding, 1-layer, Vintage Pearloid.
2 x 6mm. Length: approx. 1.60m.

**WS21K**

Binding, 1-layer, Cream. 1.5 x 7mm.
Length: approx. 1.50m.

**WS22B**

Binding, 1-layer, Black. 2 x 7mm.
Length: approx. 1.50m.

**WS22K**

Binding, 1-layer, Cream. 2 x 6.5mm.
Length: approx. 1.50m.

Blanks, Wood
& Plastic**BBALD**

Body blank, US Alder.

**BBMAH**

Body blank, Mahogany.

**PG00B**

Pickguard Blank, black, glossy.
200 x 200 x 0.25 mm, self-adhesive,
for acoustic guitars.

**PG00A**

Pickguard Blank, transparent,
glossy. 200 x 200 x 0.25 mm, self-
adhesive, for acoustic guitars.

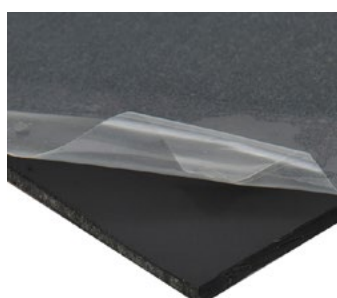
**PG51B**

Pickguard Blank, matt black,
1-layer. ca. 41 x 23cm.

**PG51S**

Pickguard Blank, black, 1-layer. ca.
41 x 23cm.

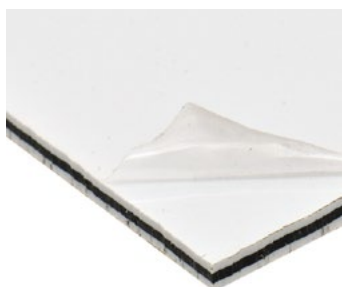

PG51W
Pickguard Blank, white, 1-layer. ca. 41 x 23cm.

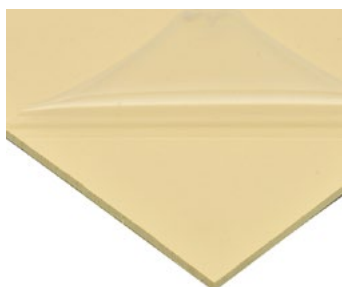

PG51K
Pickguard Blank, cream, 1-layer. ca. 41 x 23cm.

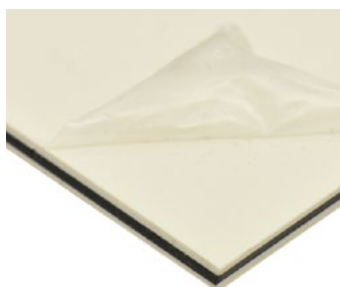

PG51A
Pickguard Blank, aged white, 1-layer. ca. 41 x 23cm.



PG51T
Pickguard Blank, tortoise, 1-layer. ca. 41 x 23cm.

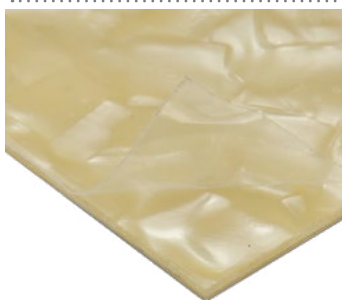

PG52P
Pickguard Blank, vintage-pearl, 1-layer. ca. 43 x 29 cm.



PG53B
Pickguard Blank, black, 3-layer. ca. 41 x 23cm.



PG53W
Pickguard Blank, white, 3-layer. ca. 41 x 23cm.



PG53K
Pickguard Blank, cream, 3-layer. ca. 41 x 23cm.



PG53A
Pickguard Blank, aged white, 3-layer. ca. 41 x 23cm.



PG54P
Pickguard Blank, white pearl, 4-layer. ca. 39 x 23cm.



PG54T
Pickguard Blank, tortoise, 4-layer. ca. 39 x 23cm.

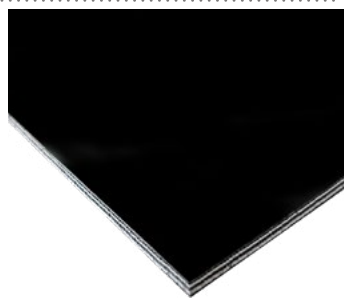

PG55B
Pickguard Blank, black, 5-layer. ca. 41 x 23cm.

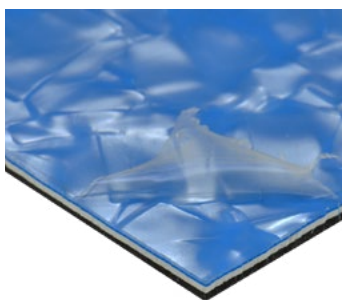

PGBLP
Pickguard Blank, blue pearl, 3-layer. ca. 41 x 23cm.

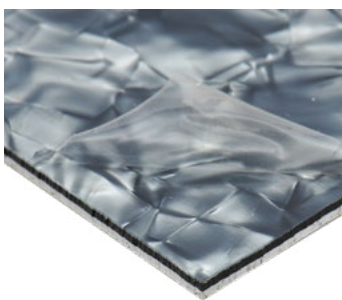

PGGRP
Pickguard Blank, grey pearl, 3-layer. ca. 41 x 23cm.

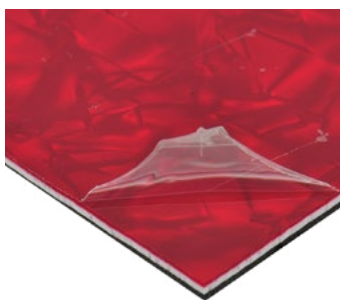

PGRDP
Pickguard Blank, red pearl, 3-layer. ca. 41 x 23cm.



PGVTP
Pickguard Blank, pearl on cream, 2-layer. ca. 41 x 23cm.

Tools



WB1000

Fret Polishing Rubber, #1000. Easy and fast fret polishing tool, ideal for rounding the edges. Dimensions: 65x18x9mm.



WB150

Fret Sanding Rubber, #150. Easy and fast fret polishing tool, ideal for rounding the edges. Dimensions: 65x18x9mm.



WB180

Fret Polishing Rubber, #180. Easy and fast fret polishing tool, ideal for rounding the edges. Dimensions: 65x18x9mm.



WB400

Fret Polishing Rubber, #400. Easy and fast fret polishing tool, ideal for rounding the edges. Dimensions: 65x18x9mm.



WS000

Fretmaster. A precision file, specially made to level frets.



WS001

Fret End File, medium. Perfect for finishing the fret ends. One side has a hollow fret file, whereas the sides are flat.



WSF34

Fret File, small. File for «crowning» the fret surface.



WSF35

Fret File, medium. File for «crowning» the fret surface.



WSF36

Fret File, large. File for «crowning» the fret surface.



WS038

Double Edge Nut File, Set. Nut file set of three files with two different sizes: .010/.026, .013/.036 and .017/.046 inches.



WS039

Fret Crowning File. High grade file for accurate fret shaping. Two 3mm fine cutting edges. Length incl. wooden handle 25cm, width 16mm.



WS045

Fretboard Guard, 1 pc. Thin stainless steel mask fits over one fret to protect the fingerboard, while you are filing, rounding or polishing a single fret.



WS10S

Triple Edge Countersink, 10mm. To enlarge any machine head holes to 10mm diameter. No sweat, no danger for the headstock, no rip!



WS63S

Triple Edge Countersink, 6.3mm. Great to enlarge holes of diameter 6.0mm to 6.3mm in potentiometer buttons to fit to American pot.



WS83S

Triple Edge Countersink, 8.3mm. To enlarge any machine head holes to 8.3mm diameter.



WSGNC

Guitar Nut Cube Minitool, stainless steel. 10mm, 11mm & 1/2" wrench for pot nuts, a 16mm socket wrench + a multi-key for all kinds of toggle switch.



WSJTC

Assembly Tool for T-Style Jacks. Special tool that helps installing the mounting bracket of a classic T-Style output jack.



WSZ02

Fret Puller. It helps you pull the wire out of the slot step by step and minimizes wood chipping. Length 150mm, width at the jaws 9mm.



WSZ03

Fret Cutter. Perfect for trimming the ends of the fretwire. The jaws are specially hardened for fret work.



WSCOOL

FROST Spray, 400ml. To age nitro-cellulose finishes. Frosts down in seconds to almost minus 50° Celsius.

Wrenches



WSF20

Binding Glue, 20ml. Special adhesive for plastic binding.



KSW12

Allen Key, 1.27mm. For US Strat Saddle.



KSW15

Allen Key, 1.5mm. For M3, allen screw.



KSW16

Allen Key, 1.6mm (1/16"). For US 1/16" / 1.6mm.



KSW20

Allen Key, 2mm. For M4 allen screws.



KSW24

Allen Key, 2.4mm (3/32"). For US 3/32" / 2,4mm.



KSW25

Allen Key, 2.5mm. For M5 allen screws.



KSW30

Allen Key, 3mm. For Floyd Rose Lock Nut.



KSW32

Allen Key, 3.2mm (1/8"). For US-Bullet.



KSW40

Allen Key, 4mm. For Trussrod.



KSW47

Allen Key, 4.7mm. For Trussrod.



KSW50

Allen Key, 5mm. For Trussrod.



KSW2L

Allen Key, extra long, with ball end, 2mm. For M4 screws. Especially useful for areas that are hard to reach. Length 100mm.



KSW80

Open-End Wrench, 8mm.



WSK60

Trussrod Key, 6mm.



WSK63

Trussrod Key, 6.35mm.

Acoustic Bridge / Pins



WSK87

Trussrod Key for Gibson, 8.7mm.



HW156

Acoustic Guitar Bridge. For Martin-style 6-string steelstring guitars. Countersunk pin holes, string spacing 55mm. Polished Rosewood.



HW100

Acoustic Bridge Pins, Brass, 6 pcs. Reduce the acoustical volume of the guitar. Very good for piezo pickups and against feedback!



HW101

Acoustic Bridge Pins, Ebony, 6 pcs. Very distinctive ebony with mother-of-pearl inlays.

Misc. Hardware



HW102

Acoustic Bridge Pins, plastic. The cheaper version, made of plastic with abalone inlays.



HW103

Buffalo Horn Bridge Pins, 6 pcs. Made of genuine buffalo horn and elegantly decorated with a mother-of-pearl dot.



HW106

Acoustic Bridge Pins, Ivory, 6 pcs. Ivory imitation with a black dot inlay.



FREST

Thumb Rest, plastic, black.



NP10B

Neck attachment sockets, 12mm, black. Package of 12.



NP10C

Neck attachment sockets, 12mm, nickel. Package of 12.



NP10G

Neck attachment sockets, 12mm, gold. Package of 12.



NP11B

Neck attachment sockets, 15mm, black. Package of 12.



NP11C

Neck attachment sockets, 15mm, chrome. Package of 12.



Endpins



EP12B

Strap Pin «Deluxe», black chrome, 17mm. 1 piece with screw.



EP12C

Strap Pin «Deluxe», chrome, 17mm. 1 piece with screw.



EP12G

Strap Pin «Deluxe», gold, 17mm. 1 piece with screw.



GRSPF

Gotoh Relic Strap Pins F-Style, aged chrome. 2 pieces with screws.

String Trees



GRSPG

Gotoh Relic Strap Pin G-Style, aged alu. 2 aluminum strap pins with screws.



GRSRT

Relic String Retainer, aged nickel. 2 pieces with screws and spacers.



Endpins



EP50B

Multi Lock Pins, black, 1 pair. Great vintage look and safe as houses! The security cap is screwed into the strap pin. 12/17mmØ. Also fits Schaller security Lock systems.



EP50C

Multi Lock Pins, chrome, 1 pair. Great vintage look and safe as houses! The security cap is screwed into the strap pin. 12/17mmØ. Also fits Schaller security Lock systems.



EP50N

Multi Lock Pins, nickel, 1 pair. Great vintage look and safe as houses! The security cap is screwed into the strap pin. 12/17mmØ. Also fits Schaller security Lock systems.



EP50G

Multi Lock Pins, gold, 1 pair. Great vintage look and safe as houses! The security cap is screwed into the strap pin. 12/17mmØ. Also fits Schaller security Lock systems.



Strap buttons



G13SB0006
Strap Button, gold, with mounting screw



G13SB0007
Strap Button, chrome, with mounting screw



13BAR0001
Truss Rod, 2 way, 14 Fret



13BAR0003
Truss Rod, 2 way, 12 Fret

Wrenches

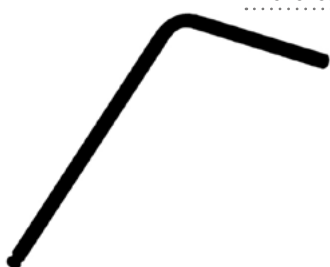

18TOOL12
Allen Truss Rod Wrench, for 2 Way Neck Adjustment, 5mm, 4 1/2" Bent Leg



18TOOL15
Allen Truss Rod Wrench, for Neck Adjustment, Ball End, 4mm. Can be used on the following models: DSS and OMSS Models, Modern Deluxe Series.



18TOOL14
Soundhole Truss Rod Driver (by GrooveTech), 5mm. Use in an acoustic guitar truss rod, this professional-grade wrench will help you maintain a comfortable guitar & peace of mind.

Acoustic Pins



18APP0001
Authentic Series Bridge & End pin set, white w/black inlay. Fits Authentic Series Guitars Only, no string slots, 7 Bridge Pins and 1 End Pin



18APP0002
Authentic Series Bridge & End pin set, white w/tortoise inlay. Fits Authentic Series Guitars Only, no string slots, 7 Bridge Pins and 1 End Pin



18APP0003
Authentic Series Bridge & End pin set, plain black. Fits Authentic Series Guitars Only, no string slots, 7 Bridge Pins and 1 End Pin



18APP0007
Luxe by Martin Bridge Pins, chrome. Made from Liquidmetal®, a Zirconium alloy. Increase in volume & sustain, without sacrificing the low-end, or richness, of the guitar's tone.



18APP17
Plain Bridge & Endpin set, ebony plain. Wood is a product of nature. Every piece of wood can be different in color and grain from another piece, even if from the same tree.



18APP18
Plain Bridge & Endpin set, black Polished.



18APP21
Bridge & Endpin set, black and white inlaid. These black bridge and endpins with white accents are sure to hold your guitar string in place while not affecting your tone.



18APP28
Bridge & Endpin set, white and black inlaid. These white bridge and endpins with black accents are sure to hold your guitar string in place while not affecting your tone.



18APP60
Bridge & Endpin set, white and tortoise inlaid. These white and tortoise bridge and endpins are sure to hold your guitar string in place while not affecting your tone.



SC-SLOCKS-NI

S-Locks, nickel, M button (4x22mm), set. New & unique solid one-piece strap button in hardened steel with self-tapping wood thread.



SC-SLOCKS-CH
Chrome



SC-SLOCKS-GO
Gold



SC-SLOCKS-BC
Black Chrome



SC-24030100

Buttons for S-Locks, M, nickel.
2 buttons + felt washers for S-Locks, thread 4,0 mm, length 22 mm
SC-24060100 S = t 3,5mm, l 18 mm
SC-24050100 XL = t 4,5 mm, l 30 mm

Chrome	M: SC-24030200 / S: SC-24060200 XL: SC-24050200
Satin Chrome	M: SC-24030300 / S: SC-24060300 XL: SC-24050300
Black Chrome	M: SC-24030400 / S: SC-24060400 XL: SC-24050400
Gold	M: SC-24030500 / S: SC-24060500 XL: SC-24050500
Ruthenium	M: SC-24030600 / S: SC-24060600 XL: SC-24050600
Satin Pearl	M: SC-24030700 / S: SC-24060700 XL: SC-24050700



SC-24040100

Lock-Wheels for S-Locks, nickel.
2 Lock-Wheels for S-Locks. Not suitable for old Security Locks.

Chrome	SC-24040200
Satin Chrome	SC-24040300
Black Chrome	SC-24040400
Gold	SC-24040500
Ruthenium	SC-24040600
Satin Pearl	SC-24040700



SC-21100100

Mounting screws set of 6 (GT, Classic Deluxe, Lyra + Hauser), nickel. 2,2 x 9,5mm.

Screws

Chrome	SC-21100200
Black Chrome	SC-21100400
Gold	SC-21100500
Ruthenium	SC-21100600
Satin Pearl	SC-21100700



SC-21110100

Mounting screws set of 6 (M6, 70's, ST6B, M4 90, M4 180, BM, BMF), nickel. 2,2 x 9,5mm.

Chrome	SC-21110200
Black Chrome	SC-21110400
Gold	SC-21110500
Ruthenium	SC-21110600



SC-21200100

Kit for buttons set of 6 (M6, Da Vinci, OF-Series), nickel. Screws 12mm, washers, spring washers

Chrome	SC-21200200
Black Chrome	SC-21200400
Gold	SC-21200500
Ruthenium	SC-21200600



SC-21230100

Kit for posts set of 6 (M6, Da Vinci, OF-Series, OG-Series), nickel. Threaded bushings 13mm, washers.

Chrome	SC-21230200
Black Chrome	SC-21230400
Gold	SC-21230500
Ruthenium	SC-21230600



SC-21210100

Kit for buttons set of 5 (M4, Da Vinci Bass, M4S Light, BM Light), nickel. Threaded bushings 13mm, washers.

Chrome	SC-21210200
Black Chrome	SC-21210400
Gold	SC-21210500
Ruthenium	SC-21210600



SC-21240100

Kit for posts set of 5 (M4, Da Vinci Bass), nickel. Threaded bushings, washers.

Chrome	SC-21240200
Black Chrome	SC-21240400
Gold	SC-21240500
Ruthenium	SC-21240600



SC-20430100

Woodscrew, nickel, 2pcs. Pivot screw

Chrome	SC-20430200
Satin Chrome	SC-20430300
Black Chrome	SC-20430400
Gold	SC-20430500
Ruthenium	SC-20430600



SC-21160100

TopLocking screws set of 6 (M6, G-Series KeyStone), nickel. Suitable for TopLocking machine heads from 2013.



SC-24090200

Schaller Buttons S-Lock Classic (without screws), chrome. 2 x S-Lock Classic strap buttons, including felt washers. Dimensions: Height: 10mm; Diameter outside: 12mm

INSTRUMENT CARE &
MAINTENANCE KITS





Cleaners



AC100-20ml

Fingerboard Lotion, 20 ml. Optimal protection + care for fingerboards! Lavender & rosmarj mix. Very thin, penetrating even fine pored ebony.



AC110-100ml

Fingerboard Lotion, 100 ml. Optimal protection + care for fingerboards! Lavender & rosmarj mix. Very thin, penetrating even fine pored ebony. Available in 100ml too (AC100-100ml)



AD003

Scratch Ex, 50 ml. Removes small scratches by applying with a cloth. Containing finest grinding additives SCRATCH EX levels unevenness by working the cloth with soft pressure.



AD004

THE Cleaner, 100 ml. Erases both grime & oxidation automatically. Works on most metal surface and paint surfaces. Maintains & leaves a moisture- and stain-resistant barrier.



Polishing Cloths

ADPBK

Polishing Cloth, black, with imprint. Premium Microtex Fabric measuring 30 x 30 cm. Perfectly suited for everyday care and cleaning of your Instrument.



String Cleaner



6582

Formula 65 Ultraglide 'String Cleaner & Conditioner', 60ml. Shields strings against tarnish and corrosion, extending their playing life.



6567

System 65 Superlube Gel pen, 2ml. Keep the moving parts of your stringed instruments working smoothly.



6524

Formula 65 Fingerboard Cleaner & Prep, 118ml. Removes buildup from crevices to restore tone, clarity and original intonation.



6532

Formula 65 Fingerboard Deep Conditioner, 59ml. Prevents warping and cracking while replenishing the proper oil balance of the wood.

Fingerboard Cleaner



6634

Pure Formula 65™ Coconut Oil Fretboard Conditioner, 118ml. Specially designed to hydrate most unfinished woods, replenishing color & highlighting grain detail



6554

Formula 65 Fretboard Ultimate Lemon Oil, 118ml. Will remove grime & return your fretboard to its original luster quickly.



6551SI

Formula 65 Fretboard Ultimate Lemon Oil, spray, 30ml. Will remove grime & return your fretboard to its original luster quickly.



6644

Pure Formula 65™ Silicone-Free Intensive Cleaner, 118ml. This completely silicone-free formula does double duty as it cleans and revitalizes even the most delicate finishes.

Polishes & Cleaner



6634

Pure Formula 65™ Nano Gloss Finishing Polish, 118ml. Proprietary wax-free formula delivers a high-gloss shine that enhances the natural beauty of your instrument's finish.



654

Formula 65 Guitar Polish, 118ml. What your guitar or bass needs to stay looking its best. Cleans your axe quickly and completely, restoring the finish to its original luster.



651SI

Formula 65 Guitar Polish, spray, 30ml. What your guitar or bass needs to stay looking its best. Cleans your axe quickly and completely, restoring the finish to its original luster.



654C

Formula 65 Guitar Polish & Cloth, 118ml. Includes a single 118ml bottle of Formula 65, along with our 100% cotton, chemical-free cleaning & polishing cloth.



6516

Formula 65 Guitar Polish, 473ml. What your guitar or bass needs to stay looking its best. Cleans your axe quickly and completely, restoring the finish to its original luster.



6574

Formula 65 Bodygloss Cream of Carnauba, 118ml. The highest-grade carnauba wax, in a proprietary formula. Polishes and beautifies.



Polishing Cloths

5400-BOX

Polish Cloth, 12-Box. 100% soft lint-free cotton flannel. Non-treated material. Perfect for applying lemon oil, polish and string cleaner.



5410

System 65 Micro Fine Fret Polishing Cloth. Will polish your frets to remove all wear elements and tarnish, while gently restoring the luster to your frets.



5430

Guitar Finish Cloth. Soft absorbent cloth that is non-abrasive and perfect for all popular guitar finishes. Lifts and eliminates dust, grime and fingerprints.



5435

Plush Microfiber Polish Cloth. Made from terrycloth microfiber, allows for the most efficient removal of dust and fingerprints while pampering the finish of your instrument



HE97

Miracle Cloth by Herco. Removes scratches and stains. Cleans and polishes all wood or metal instruments, even lacquer finishes.



6500

Formula 65 Cleaning Kit. 654 Polish&Cleaner, Bodygloss Cream Carnauba, Ultraglide 65 String Cleaner, Fingerboard Cleaner&Prep, Deep Conditioner, 2x 100% cotton cloths.

Kits



6501

Formula 65 Polish & Cream Cleaning Kit. Includes 654 Formula 65 Polish&Cleaner, 6574 Bodygloss Cream Carnauba, 100% cotton cloth.



6502

Formula 65 Fingerboard Cleaning Kit. Includes Fingerboard Cleaner & Prep, Deep Conditioner Oil, 100% cotton polishing cloth.



6503

Formula 65 Fingerboard & Body Cleaning Kit. Fretboard 65 Ultimate Lemon Oil + Formula 65 Polish, keep your instruments in top shape. Also in 30ml Kit: GA59



6504

Formula 65 Body, Fretboard & String Cleaning Kit. All you need to properly maintain your guitar's fingerboard, finish, and strings.



DGT121

Universal String Change Tool Kit. Everything you need to keep your instrument in top playing shape, whether you're doing a quick string change or a complete setup. Case include.



DGT122

Universal Complete Setup Kit. Everything you need to keep your instrument in top playing shape, whether you're doing a quick string change or a complete setup. Case include.



DGT301

String Change Tech Kit. Everything you need to change your strings: cloths, 6503 Body & Fingerboard Kit, mat, tool kit, magnetic Tray, neck cradle.



DGT302

Complete setup Tech Kit. Everything you need to treat your guitar or bass: cloths, 6504 System 65 Guitar Tech Kit, setup kit, mat, magnetic Tray, neck cradle.

Tools



NC65

System 65 Neck Maintenance Station Neck Cradle.



GM65

System 65 Guitar Setup Mat. Get to work on your instrument without worrying about dinging or scratching it up. Size: 58cm x 45cm.



DTM01

System 65 Magnetic Parts Tray. It's perfect for holding pickguard screws, pickup springs, washers, nuts, saddles, string trees, and any other parts you can't afford to lose.



String Cleaner



099-0521-100

Speed Slick Guitar String Cleaner. Restores and extends string life, provides ultra-slick feel for increased speed and more effortless playing. Cleans multiple strings at once.

Fingerboard Cleaner



099-0534-000

Custom Shop Fingerboard Remedy, 60ml. High-grade carnauba formula, contains no silicones, resins, polymers, bonding agents or alcohol.

Polishes



099-0535-000

Custom Shop Guitar Quick Clean, 60ml. Increase the luster of your instrument onstage and off. High-grade carnauba formula, contains no silicones, resins, polymers or alcohol.



099-0536-000

Custom Shop Guitar Polish, 60ml. Glossy sheen, this polish's ultraviolet filtering agents will help increase the lifespan of your finish. High-grade carnauba formula.



099-0537-000

Custom Shop Guitar Cleaner, 60ml. A formula with a special blend of ultra-fine polishing agents that restore instruments to their original shine. High-grade carnauba formula.



099-0501-006

Guitar Polish, 118ml. Give your instrument some extra TLC with our signature polish, which has been formulated to work on the most delicate of finishes.



Polishing Cloths

099-0523-000

Factory Microfiber Cloth. Durable microfiber construction, this cloth is great for maintaining the look of any instrument, letting you show off your sheen without scratches or smudges.



099-0524-000

Dual-Sided Super-Soft Microfiber Cloth. With 2 sides for polishing & cleaning with precision, perfect for attracting & holding oil, grease, dirt, film, dust and other contaminants.



099-0525-000

Premium Plush Microfiber Polishing Cloth. Removes and traps dirt, dust and grime, won't scratch chrome or polished surfaces.



Kits

099-0539-000

Custom Shop 4-Step Cleaning Kit, 4-pack. Reliable four-step cleaning kit. Cleaner, Polish, Quick Clean and Fingerboard Remedy.



099-0519-000

Custom Shop Tool Kit by Cruz-Tools. Inside: 4-in-1 screwdriver, hex wrenches, ruler, diagonal cutter, capo, feeler gauges + guitar string winder.



099-0528-000

4oz Polish and Shop Cloth, 2 Pack. Featuring Fender signature 4oz (118ml) polish and dual-sided super soft microfiber cloth

ghs strings.

String Cleaner



A87

Fast Fret. Apply to your strings and fingerboard to remove built up dirt and grime. Keeps the strings sounding bright and new, extending the healthy lifetime of any strings.

Fingerboard Cleaner



A77

Fingerboard Care Kit. Includes a Fret Buffer, GHS Fingerboard Cleaner/Conditioner and a Cloth.

galdol

Cleaners



WS041

Oil & Wax, Set. To protect unfinished wooden surfaces. 2 sheets of fine sanding paper for final sanding.



WS042

Hard Wax, 100ml. For Bodies & necks. Bees wax with 20% addition of Carnauba wax! Hardens crystalline and gives a resistant and smooth wood surface.



WS150

Workbench Rest, 100x50x0.4cm. Safely rest the instrument on the work table. This self-adhesive non-skid is sized for guitars & basses.



Tools

ACFSG

A.A.A Fret Shield. Protects strings from scratching the frets and also absorbs humidity inside the case. Put it between strings and fingerboard before you close the case.

ORIGINAL SWISS
by La Tromba®

Fingerboard Cleaner



LT-FO

Original Swiss Fingerboard Oil, bottle 50ml. Removes dirt, protects the wood from drying out and thus reduces the risk of cracking.

Polishes



LT-GP

Original Swiss Guitar Polish & Cleaner, spray 80ml. Cleans your instrument and protects it against aggressive substances with a non-smearing, high-gloss wax film.



Humidification



18AHG

Guitar Humidifier. Made from the finest non-vinyl and non-allergenic resin. Absorbs ten times its weight in water and slowly emits moisture through the holes.

Cleaner



18A0073

Premium Guitar Polish & Cleaner, 178ml. Saving time and money. Use the same product Martin Guitar craftsmen use at home.



18A0111

LUXE Guitar Detailer, single packet with wax infused towelette. Premium wax that cleans and protects all surfaces of guitars. Developed exclusively with Zymöl™

Clothes



18A0091

Polish Cloth (with Logo). Create the desired shine without scratches using the Martin Polishing Cloth. Use with Martin Polish for the perfect finish. 100% flannel cotton.

Tools



18A0076

Microfiber Guitar Neck Rest. A soft microfiber top that gently nestles the neck and prevents scratches. Smooth polyester pellet, heavier pellets at the bottom for more weight and stability.



LAST ONES

18A0099

Axe Mat, 17" x 19 3/4". Protects the instrument you love so you can focus on your work instead of worrying about nicks and scratches.



Cleaner



SE-GUIT-POL

Guitar Polish, 118ml. Protects, re-creates & beautifies your guitar's finish! Leaves no wax build-up. Silicone free, eco-friendly dispenser.



Fingerboard Cleaner



UW-GB-50

Fingerboard Oil, 50ml. Mixed according to a recipe that has been family-owned for centuries. It consists of various oils.



UW-GB-100

Fingerboard Oil, 100ml. Mixed according to a recipe that has been family-owned for centuries. It consists of various oils.



UW-GB-1000

Fingerboard Oil, 1l. Mixed according to a recipe that has been family-owned for centuries. It consists of various oils.

WHARRY



Spare Parts
The Bible